

**UNIVERSITY OF GENOA**

**POLYTECHNIC SCHOOL**

**DIME**

**Department of Mechanical, Energy, Management  
and Transportation Engineering**



**Ph.D. THESIS**

in

**MACHINE AND SYSTEMS ENGINEERING FOR ENERGY, THE EN-  
VIRONMENT AND TRANSPORT**

Curriculum

**MATHEMATICAL ENGINEERING AND SIMULATION**

XXXIII CYCLE

**MODELING HYPERBARIC CHAMBER ENVIRONMENT  
AND CONTROL SYSTEM**

**Supervisor:**

Chiar.<sup>mo</sup> Prof. Ing. Agostino Bruzzone

**Candidate:**

Kirill Sinelshchikov

2021

## Abstract

Deep water activities are essential for many industrial fields, for instance in repairing and installation of underwater cables, pipes and constructions, marine salvage and rescue operations. In some cases, these activities must be performed in deep water and hence require special equipment and prepared and experienced personnel. In some critical situations, remotely controlled vehicles (ROVs) can't be used and a human diver intervention is required. In the last case, divers are required to perform work at high depths, which could be as low as 300m below the water surface. Usually, this is the limit depth for commercial diving and when operations must be carried out even deeper, ROVs remain only possibility to perform them. In the past, the safety regulations were less strict and numerous operations on depth of 300-350 meters of seawater were conducted. However, in the beginning of the 90s governments and companies started to impose limits on depths of operation; for instance, in Norway maximum operational depth for saturation divers is limited to 180 meters of seawater (Imbert et al., 2019).

Obviously, harsh environmental conditions impose various limitations on performed activities; indeed, low temperature, poor visibility and high pressure make it difficult not only to operate at depth, but even to achieve the point of intervention.

One of the main problems is related to elevated pressure, which rises for about 1 bar for each 10 meters of water depth and could achieve up to 20-25 bars at required depth, while pressure inside divers' atmospheric diving suites must be nearly the same. Considering this, there are several evident limitations. First is related to the fact that at high atmospheric pressure oxygen becomes poisonous for human body and special breath gas mixtures are required to avoid health issues. The second one is maximum pressure variation rate which would not cause damage for the human body; indeed, fast compression or decompression could easily cause severe damages and even death of divers. Furthermore, surveys found that circa 1/3 of divers experience headache during decompression which usually last for at least several hours and up to several days (Imbert et al., 2019). The same study indicates that majority of the divers experience fatigue after saturation and it lasts on average more than 4 days before return to normal. Obviously, risk of accidents increases with high number of compression-decompression cycles.

To address these issues, in commercial deep water diving the common practice is to perform pressurization only one time before the start of the work activity which typically lasts 20-30 days and consequent depressurization after its end. Hence, divers are living for several weeks in isolated pressurized environments, typically placed on board of a Dive Support Vessel (DSV), usually barge or a ship, and go up and down to the workplace using submersible decompression chamber also known as the bell.

While long-term work shifts provide numerous advantages, there is still necessity to perform life support supervision of the plant, the bell and the diving suits, which require presence of well qualified personnel. Currently, most of training activities are performed on empty plant during idle time, but obviously this approach is low efficient and costly, as well as accompanied by the risk to broke equipment.

To address such issues, this research project proposes utilization of simulator of plant and its life support system, devoted to train future Life-Support Supervisors (LSS), taking into account gas dynamics, human behaviour and physiology as well as various aspect of operation of saturation diving plants.

# Index

1.	Introduction .....	5
1.1.	First Deep Water Diving .....	5
1.2.	Examples of Modern Underwater Activities and Operations .....	8
1.3.	Dangers of Deep Water Diving.....	10
1.4.	Autonomous Systems.....	11
1.5.	Definition of Objectives .....	12
2.	Framework of Operation .....	13
2.1.	Saturation Diving and Typical Industrial Plants .....	13
2.1.1	Control System .....	18
2.1.2.	Control Devices, Sensors and Gas Analysers .....	19
2.2.	Saturation Diving Procedures .....	29
2.2.1.	Compression and Decompression .....	29
2.2.2.	Routine Operations.....	30
2.2.3.	SDC Operation .....	30
2.2.4.	Object Passing .....	32
2.2.5.	Shower and Toilet Usage .....	32
2.2.6.	Evacuation.....	32
2.2.7.	Blackout .....	33
2.2.8.	Pressure Loss.....	33
2.2.9.	Dangerous Variations of Gas Concentrations and Stratification .....	34
2.2.10.	Emergency Entry of Personnel.....	34
2.2.11.	Chamber pollution.....	34
2.2.12.	Emergency Operation Considerations.....	35
2.3.	Underwater Medicine .....	37
2.3.1.	Barotrauma .....	38
2.3.2.	Vertigo.....	39
2.3.3.	Hyperoxia and Hypoxia .....	40
2.3.4.	CO2 Poisoning .....	41
2.3.5.	Nitrogen Narcosis.....	42
2.3.6.	Hypothermia and Hyperthermia.....	43
2.4.	Non-Verbal Communication .....	44
2.4.1.	Hand Signals .....	44
2.4.2.	Light Signals .....	47
2.4.3.	Tapping Code .....	47
3.	State of the Art in Simulation for Training on Plants.....	48
3.1.	Simulators for LSS Training .....	48
3.1.1.	DSS-100 .....	49
3.1.2.	Dive Control Simulator .....	53
3.1.3.	Dynamic Ship Positioning Simulators .....	54
3.2.	Simulators for Personnel working in Modified Atmosphere .....	54
3.2.1.	Simulators based on real hyperbaric chambers.....	54
3.2.2.	Aerospace Industry and Environmental Simulation .....	56
3.3.	Virtual and Augmented Reality for Plant Operators.....	57
3.3.1.	Virtual Reality .....	57
3.3.2.	Augmented Reality.....	60

3.3.3.	VR & AR Equipment Comparison .....	65
3.4.	Portable Solutions for Training and Safety .....	66
3.5.	Simulation for Emergency Management and Operations .....	69
4.	Distributed and Interoperable Simulation .....	71
4.1.	High-Level Architecture .....	71
4.2.	RPC-based Systems .....	74
4.3.	Distributed Ledger and Blockchain .....	77
4.4.	Proxies and Gateways for Distributed Systems .....	81
4.5.	Other Distributed Simulation Systems .....	82
5.	System Requirements .....	83
5.1.	Goals and Tasks .....	88
6.	Principal Simulation Models .....	89
6.1.	Gas Model .....	89
6.2.	Plant Initialization .....	95
6.3.	Physiological Reactions and Human Behaviour .....	97
7.	The Simulator .....	105
7.1.	Instructor and User Interfaces .....	105
7.2.	Time Management .....	107
7.3.	Loading and Saving of Scenarios .....	107
7.4.	Hatches Control .....	108
7.5.	Supervision on the Plant's State .....	108
7.6.	Operation modes .....	109
7.7.	Plant Controls .....	110
7.8.	Auxiliary Functions .....	111
7.9.	Integration and Interoperability .....	111
8.	Verification and Validation .....	117
8.1.	Theory and Methodology .....	117
8.2.	Model Verification & Validation .....	118
8.3.	Compression of the Chamber .....	120
8.4.	Atmosphere Washing .....	120
8.5.	Sensitivity Analysis .....	121
8.6.	Gas Flow Error Calculation .....	126
8.7.	Experimentation with SME .....	127
9.	Conclusions .....	130
10.	References .....	132

# 1. Introduction

Since thousands of years, humans are exploring underwater environment. For example, in the Roman Empire royal purple dye, required to colour clothes, was extracted from sea snails, while in other cultures it was common in order to collect pearls, corals, sea sponges but also for spearfishing (McGovern & Michel, 1985). Obviously, in the distant past only ways to perform such activities were free-diving and in some particular cases snorkelling, which were limiting maximum time available for underwater activities. One of consequences of the difficulty of this kind of operation was the elevated cost of obtained goods. For example, pearls in such antique civilizations as Roman Empire, pharaonic Egypt, India and Assyria were considered as highly precious objects, usually available only to noble citizens (Avial-Chicharro, 2019). Similarly, valuable red corals in Mediterranean sea were harvested starting from 1 century BC.

Another, but less typical, activity in this time period was marine salvage. Indeed, there were attempts to recover goods from sunked ships, but due to technology limitations many of them had only limited success.

More recent example of marine salvage is cannon recovery from sunked Vasa ship near Stockholm; important to note that in this case a diving bell was one of critical instruments which allowed to conduct the whole operation (Mayol, 1996).

The situation drastically changed only after the industrial revolution with development of more advanced diving equipment, such as more advanced diving bells, self-contained underwater breathing apparatus (SCUBA) and ultimately saturation diving techniques.

## 1.1. First Deep Water Diving

One of main technological advances in the field of diving is development of a diving bell, which allowed to deliver divers at unreachable for a free diver depth. This type of diving chambers got its name due to external similarity with a bell as presented in the following figure. This system normally foresees supply of the breathing gas for a bell from the surface through a hose, however, the atmosphere inside can be also self-contained. An obvious characteristic of this kind of systems is that pressure control is not required due to the fact that it is always equal to the pressure of the water outside, but for the same reason it must be operated carefully to prevent fast compression or decompression illness of divers inside it, which is especially dangerous in case of fast decompression during rising phase. Despite this consideration, simplicity of construction allowed its utilization much earlier than the beginning of the industrial revolution. Indeed, some sources state that apparatus of this kind were used by Alexander the Great in 332 B.C. (Davis, 1934).



*Figure 1-1. First diving bells*

In any case, diving bells became widely used since the middle of the 17th century after development of first air pumps, which was one of the most important steps in evolution of diving bells. Main difficulties these years were atmosphere control and a lack of heating and lighting necessary for divers.

Next significant technological breakthrough in this field was done in the second half of the 19th century thanks to development of various anthropomorphic diving dresses with helmets as shown in the next figure. These new solutions allowed to supply an air directly to divers through a hose, hence increasing divers' mobility.



*Figure 1-2. One of first diving suites*

In the same period of time techniques of carbon dioxide's removal from the air using various chemical reactions were invented, allowing the development of completely autonomous submersible vessels and suits. Although this gas captured effect has relatively short duration, these “rebreathers” permit to significantly increase divers' mobility. Indeed, these technologies were lately upgraded to SCUBA (Self Contained Underwater Breathing Apparatus) sets which are used nowadays for a diving up to tens of meters.

It is interesting to note, that while most of advances in this field were economically or military motivated, one of most known promoters of this type of diving equipment who also contributed into evolution of diving suites and was one of inventors of aqua-lung, Jacques-Yves Cousteau, used it extensively for oceanography (Matsen, 2009; Cousteau & Dumas, 1953).

Most recent big step was done in the middle of 20th century with invention of the saturation diving, which became widely used at the present. This technique opened up many opportunities because it allows to surpass constraints of a human body, such as maximum acceptable pressure and compression rate. In this case, divers live in modified environment in a hyperbaric complex above the sea surface, for example installed on a barge, and go up and down

using a closed bell. Photo of the plant of this type is shown in the next figure. Details of this technique are presented in the next section in description of a typical plant.



*Figure 1-3. Example of a saturation diving plant on a barge*

## **1.2. Examples of Modern Underwater Activities and Operations**

In the second half of XIX century a conceptually new type of underwater infrastructure was requested – submarine communications cable (Charles, 1898). Indeed, starting from development of telegraph it became evident necessity to guarantee connectivity not only in boundaries of same land mass (e.g. continent, island), but all around the world. In that time period the most requested communication channels were between North America and Europe. In the beginning of XX century the underwater telegraph network expanded to connect most of Commonwealth of Nations.

The next step of increase of importance of underwater communication was caused by development of fibre-optic cables which much higher bandwidth. For example, while first transatlantic telephonic line (TAT-1) has capacity to support simultaneously only 35 calls, first fibre-optic line allowed contemporary utilization by 40000 users (Glover, 2005).

Most operations of installation of these cables are performed by special ships without diver intervention, however, in case of necessity of repair autonomous vehicles and human divers are required to fix it. Indeed, this type of infrastructure can be damaged by different factors, starting from natural ones such as seismic activity and currents and up to artificial ones, for example collision with anchor or fishing trawlers.

Similarly, nowadays there are numerous underwater power cables which require installation and repairs (International Cable Protection Committee, 2011).



Among other motivations to achieve seabed in deep water there is also archaeology; in some cases, artefacts, such as amphora or ship wreck sites are situated in non-accessible for air diving depths (Keith & Frey, 1979).

Most known nowadays scope of offshore commercial diving activity is related to the field of oil and gas. Indeed, oil platforms require a lot of pipeline connection work as well as continuous support in terms of underwater inspection, maintenance and repairs (Bevan, 2005).

A quite particular field of oil extraction is that one which employs FPSO (Floating Production Storage and Offloading). Indeed, fixed seabed pipelines have little to no economic benefits in case of remote location of oil wells, or in case of their excessive depth. In this case floating sites are used to extract, store and offload products (de Ruyter, Pellegrino & Cariou, 2005). Often, FPSOs are built on top of an oil tanker, taking advantage of its huge storage capacity, but sometime new ad-hoc ships are built for this purpose. This approach has several advantages respect to traditional platforms; for example, in case when oil field is relatively small it could be economically inefficient to install a platform. Meanwhile, FPSO could be easily relocated to new position after depletion of old field. In case FPSO, divers are usually employed in connection and reconnection phases of operation of the ship. Indeed, as shown in the following figure, this kind of vessels is characterized by big amount of connected infrastructures. In particular, operation of the vessel requires installation and maintenance of:

- Anchoring (mooring) in order to prevent displacements of the vessel and consequent damage to equipment.
- Installation of production tree. As tree or “Christmas tree” in oil & gas industry is called an assembly of spools, valves and fittings required to provide pressure regulation when connecting to a well (oil, gas or water injection wells).
- Installation of injection trees which are required to maintain constant pressure in the underwater reservoir.
- Connection of risers, which is a special type of piping for vertical transportation of gases and liquids.
- Attachment of control cables and sensors.

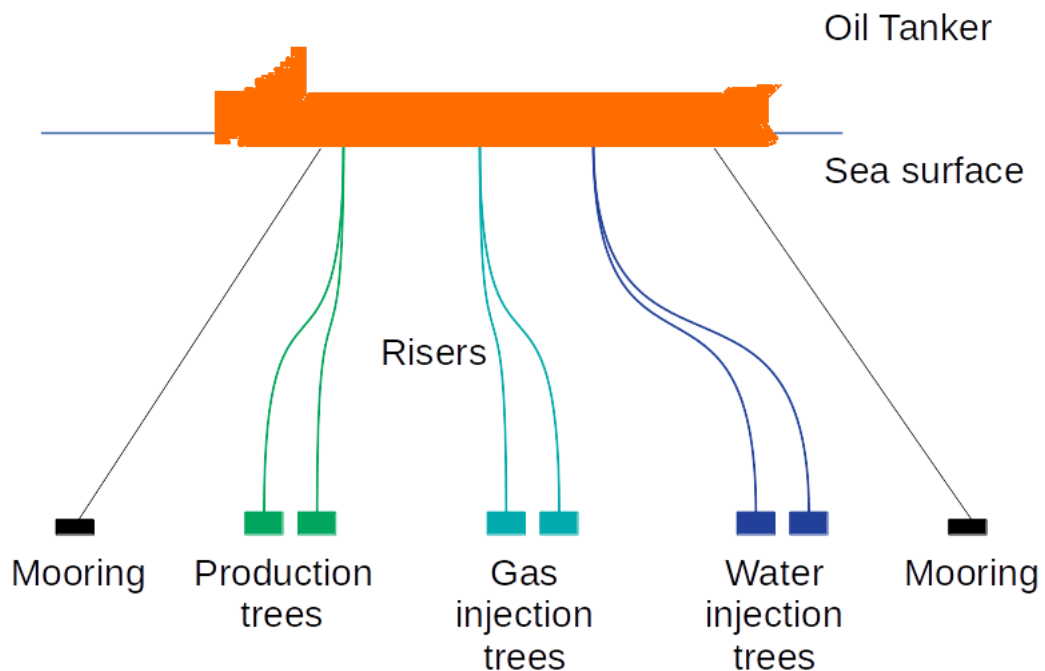


Figure 1-4. FPSO operation

### 1.3. Dangers of Deep Water Diving

Obviously, such work environment is very dangerous for several reasons: high pressure, low temperature and visibility at first place. Indeed, pressure of water grows approximately at 1 bar for each 10 meters of sea water, hence at 200-meter depth the relative pressure is about 20 bars. The problem is that at this pressure oxygen becomes toxic for a human being, so special gas mixtures with low oxygen concentration must be used. A typical breath mixture contains 2 gases - oxygen and some inert gas, for example helium or nitrogen. The acceptable mass concentration of oxygen depends on depth and decreases from normal 20% up to 4% in case of 200-meter deepness, which usually is near the maximum for a commercial diving. However, the main problem is not the pressure itself but compression and decompression rates. In case of rescue operations some specially prepared divers with excellent health can achieve such a high pressure as 20 bars in few hours and turn back in one day, but for a normal operation of commercial divers few days for both procedures are required. In some situations, decompression requires even one week. Obviously it is not convenient to make a difficult for life-support supervisors (LSS) and divers compression-decompression cycle for each work shift, especially considering that whole cycle requires many days. Indeed, the US navy diving manual identify maximum acceptable compression and decompression rates, which depend on the actual pressure but also requires numerous intermediate stops. Taking average values for estimation, the maximum compression rate in case of immersion to 200m depth would be about 30 m/hour, which makes it necessary to spend near 7 hours just to reach the working depth. However, in case of normal operation the decompression is even slower and corresponding rate is closer to 1-2 m/hour, and the decompression would require almost one week. Hence, only down and up trip would require more than one week. Considering this, the best solution which is currently used by commercial divers is to use special high pressure living hyperbaric chambers installed on a barge or on a ship and to reproduce artificially conditions under the sea and go down to the bottom and back up to

make a shift using a special lift - submersible decompression chamber (SDC) – modern version of antique bell.

Such operations are nowadays have strictly defined safety related procedures, equipment and policies, however, as it is described in the following chapters, number of small accidents and even fatalities in this field is relatively high.

For instance, according to the Bureau of Labor Statistics (BLS, 2019a; 2019b; 2019c) of USA, in 2017 there were 5 fatal occupational injuries, while number of the non-fatal ones is 130, from which 110 lead to more than one-month absence from work. Considering that estimated number of commercial divers in USA in 2019 is 3420 (BLS, 2020), it is possible to conclude that a commercial diver in USA has relatively high probability to face severe consequences for his or her health, considering very high level of preparation, health checks and quality assessment of this kind of personnel.

Indeed, in order to be allowed to perform commercial diving, a person should obtain proper certification, demonstrating that requirements are satisfied (e.g. holding a recognized diver certificate) and accredited training program and hands-on experience have been successfully completed (IMCA, 2020b). These courses include but not limited to underwater operations, diving medicine, safety procedures and operation of equipment. Usually, in order to obtain higher level of certification (e.g. to be allowed to dive deeper) it is required to have valid certification of lower level of diving and confirmed experience of defined number of hours; typically, each stage requires hundreds hours of courses and practice (Bruzzone et al., 2017f).

#### 1.4. Autonomous Systems

Apart from human interventions, in many cases Remotely Operated Vehicles (ROVs) are used. Indeed, in this case it is possible to avoid time-consuming operations of compression and decompression of personnel as well as related risks to health and life of personnel. Furthermore, in case of utilization of autonomous or remotely controlled vehicles number of personnel required to support operations could be lower.

In the context of the research, it is foreseen possibility of feature integration of components suitable for training autonomous system operators. Indeed, often divers and autonomous systems are deployed from the same vessel and their activities are coordinated. Hence, possibility to combine training of LSS, Diver Supervisor and ROV operator could be useful.

Considering this, industry of deep water operations follows other industrial sectors and tends to employ autonomous systems in order to address safety issues (Bruzzone et al. 2017b; Bruzzone et al. 2019b; Bruzzone et al. 2019c; Frascio et al., 2019). The next figure illustrates virtual prototyping of an unmanned ground vehicle (UGV) dedicated to support human operators in high risk areas. In this example, the system is intended to perform one of most dangerous operations in an industrial plant and the simulation is used to support its development. Indeed, it is possible to check different configurations, accessibility constraints interactions with other systems and personnel before physical system is available, hence optimize its development and exclude dead-end solutions since the beginning. Furthermore, once the real system is ready, its digital counterpart can still be used to support development of procedures, test modifications as well as to train personnel without risk of creation of damage.



*Figure 1-5 Virtual prototype of autonomous system to support operation in dangerous industrial environments*

### **1.5. Definition of Objectives**

Deep water diving is complex and dangerous activity and is characterized by long-time negative consequences to divers' health even after normal operation. Furthermore, existing practice of training on real empty plants has numerous limitations and do not allow to a trainee to experience all aspects of Life Support controls. Considering this, it is possible to identify following principal limitations of actual procedures:

- Empty but functional saturation diving plant is required for training, causing idle costs as well as risk to damage equipment;
- Empty plant cannot provide proper feedback regarding vital parameters of divers, hence, trainee could perform potentially harmful action and do not realize it;
- Practical impossibility to properly simulate emergency situations.

These issues are often make training process very expensive and low efficient. Considering this, it is proposed development of a simulation based solution capable to address these problems. In particular, it is essential that the solution has following critical capabilities:

- Possibility to reproduce all activities normally performed by LSS in life support control rooms, including interactions with control equipment;
- Realistic behaviour in terms of gas & thermodynamics;
- Model of divers and their principal vital parameters as well as reactions to external factors typical for environments of interest;
- Preloading of scenarios, including both normal and emergency conditions.

Considering this, it is evident necessity to conduct proper research in order to identify particular requirements of the proposed system as well as to analyse existing solutions and technologies.

## 2. Framework of Operation

Modern commercial saturation diving foresees operation at depth up to 200-300 meters below water surface and is requested principally for such tasks as construction and inspection of underwater installations; for example, it is used in inspection of dams and platforms, installation of pipes, cables etc. (Bissett & Viau, 2003).

Considering that the whole research project addresses such specific field of operation, it is essential to perform detailed analysis of operation of this kind of industrial plants in order to identify requirements and to build realistic and useful solution suitable for training of life support supervisors. In particular, this chapter presents study of:

- Field of operation of saturation diving plants.
- Structure of the plants and their control equipment.
- Procedures.
- Human behaviour, safety and diving medicine.

### 2.1. Saturation Diving and Typical Industrial Plants

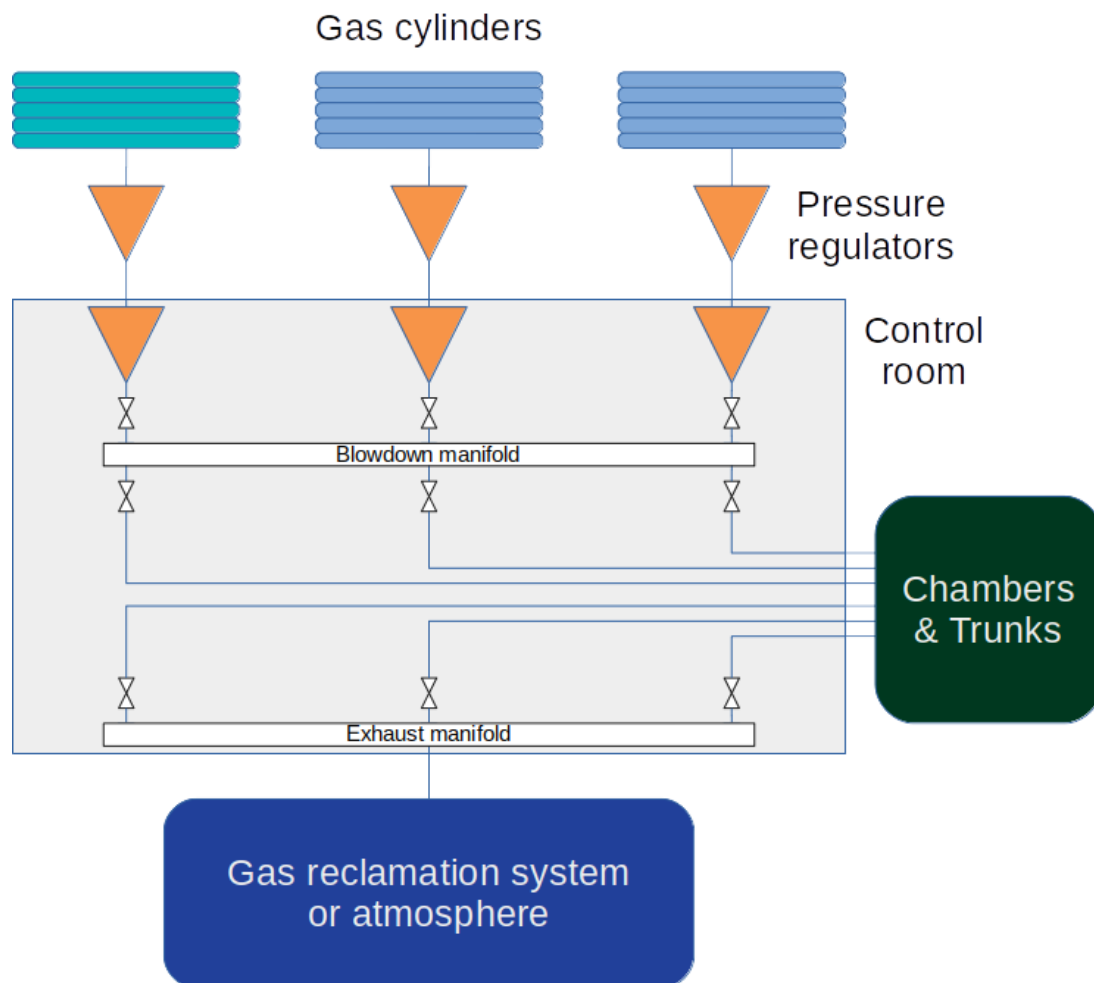
As anticipated, when analysing saturation diving it is necessary to consider not only underwater activities, but also operation of life support system of bell and numerous auxiliary systems. Indeed, typical saturation diving plant contains following essential parts:

- Living chamber
- Compression and decompression chamber
- Submersible decompression chamber (Bell)
- Rescue chamber
- Bath
- Auxiliary systems (locks for passing objects)
- Control system

Normally, each chamber and connection trunks have their own gas mixture inputs (blow-down) and output (exhaust), meanwhile principal chambers have connectors also for gas and pressure analysis. Furthermore, for safety reasons some chambers have inputs for pure oxygen and an emergency built in breathing system (BIBS) with masks which are used in case of problem with gas contamination or sudden decompression. In normal operational conditions BIBS's blowdown and exhaust are completely separated from the plant's gas supply system and BIBS gas mixture could be exhausted in chamber only in case of leakage.

Often, exhaust of gas from chambers is connected directly to the atmosphere, simplifying discharge of the gas. However, considering relatively high price of the gas (e.g. pure hydrogen or nitrogen), in some cases gas reclamation systems are used. They allow to treat exhausted gas with the objective to reuse it in the future. This approach allows to reduce exploitation costs of the plant but requires initial investments.

The principal idea of the gas supply system and several main components (gas cylinders, pressure regulators, blowdown & exhaust manifolds and corresponding valves) are presented below.



*Figure 2-1 Gas supply system.*

In order to operate at depth special gas mixtures with low concentration of oxygen are essential. Considering that oxygen level depends on actual working pressure and on corresponding depth and that activities are often required to be done in quite wide range of depths, it is common practice to have available several gas cylinder packs with slightly different mixtures. For instance, reference plant normally carries following helium-oxygen mixtures:

- Mixtures A and B for normal plant operation
- Mixture C for the bell
- Pure oxygen

The gases are stored at high pressure which could arrive at 100 bars. Typically, a mixture of an inert gas and oxygen is used in such plants, most common combinations are:

- Nitrox (nitrogen and oxygen), it is usually used for shallow water diving.
- Heliox (helium and oxygen) – most commonly used in saturation diving. A tiny amount of nitrogen could still be present in the chamber after initial compression phase.
- Trimix (oxygen, nitrogen and helium) – based on Nitrox but includes helium to avoid narcosis
- Hydrox (hydrogen & oxygen) – for more than 300m depths.
- Hydreliox (hydrogen, helium & oxygen) is an exotic gas mixture for extreme depth diving. IT was used for instance for 1992 record 701m pressurization, which then

required however 24 days of decompression and 2 and half months of medical surveillance (Gardette et al., 1993).

In the following image it is presented a typical configuration of a living part of a saturation diving plant installed on board of a barge. In particular, it is possible to see a minimal set of chambers and locks required for safe and efficient operation. Indeed, the presented plant includes a living room where divers sleep and spend most of their time, the bell or submersible decompression chamber, which is required to go to the seabed, transfer chamber called also TUP (Transfer Under Pressure) for safe operation of the bell and other auxiliary functions (for instance it can be used to place toilet) and the rescue chamber. Typically, rescue chambers are bigger than the bell due to the fact that they are required to handle all divers for extended period of time in case of evacuation. It is important to note that the available to the divers space is very small; for example, the living room could have volume of only 15m<sup>3</sup> and to accommodate contemporary 4 divers. All chambers are typically interconnected by trunks equipped with a hatch on both ends in order to guarantee safety of operation. In some cases, transfer chamber is used to rapidly deploy a person inside the plant, which usually occurs when a professional medical intervention is required inside and the long decompression cycle is not acceptable for the patient.

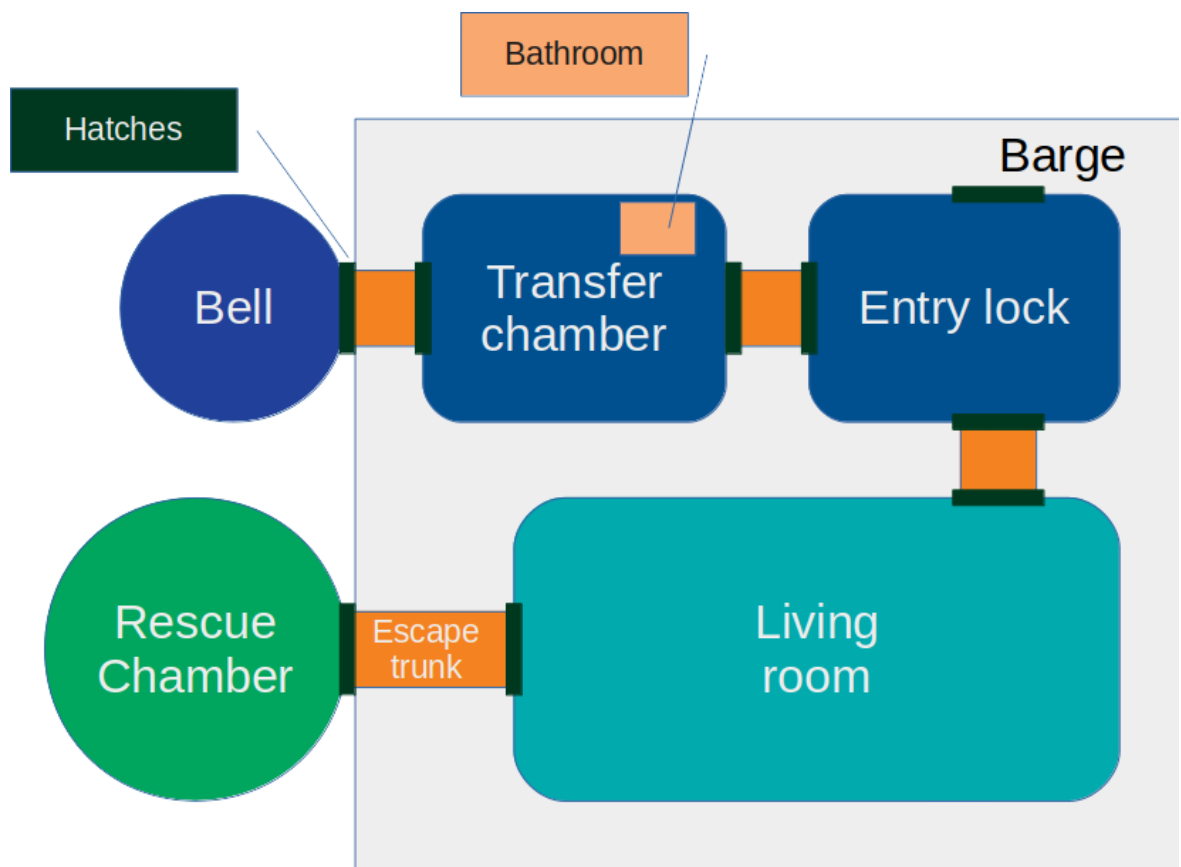


Figure 2-2. Example of pressurized part of a saturation diving plant, view from the top.

The bells is essential for the operation of the plant; indeed, it is the only way the divers could achieve working depth. In order to submerge the bell with the divers, first it is necessary to

ensure that the bell's ballast, which is necessary to avoid unnecessary displacements, is deployed using dedicated winches. After that the bell could start its journey to the seabed, while its movement is regulated by bell winches; contemporary, umbilicals for gas mixture provisioning are unrolled, as presented in the following figure. The bell operation requires also several auxiliary systems, such as hot water umbilical for diver heating, gas reclaim hose, communication and power supply cables and pneumofathometer for measurement of the divers' depth.

There are several important considerations related to the bell management in case of emergency, which are mostly caused by rupture of one of bell cables. In such situations the divers and LSS have several possibilities to return to the surface:

- Use ballast cables to lift up contemporary bell and the ballast.
- Use umbilical to lift the bell
- Release the bell's small ballasts to give it positive buoyancy.

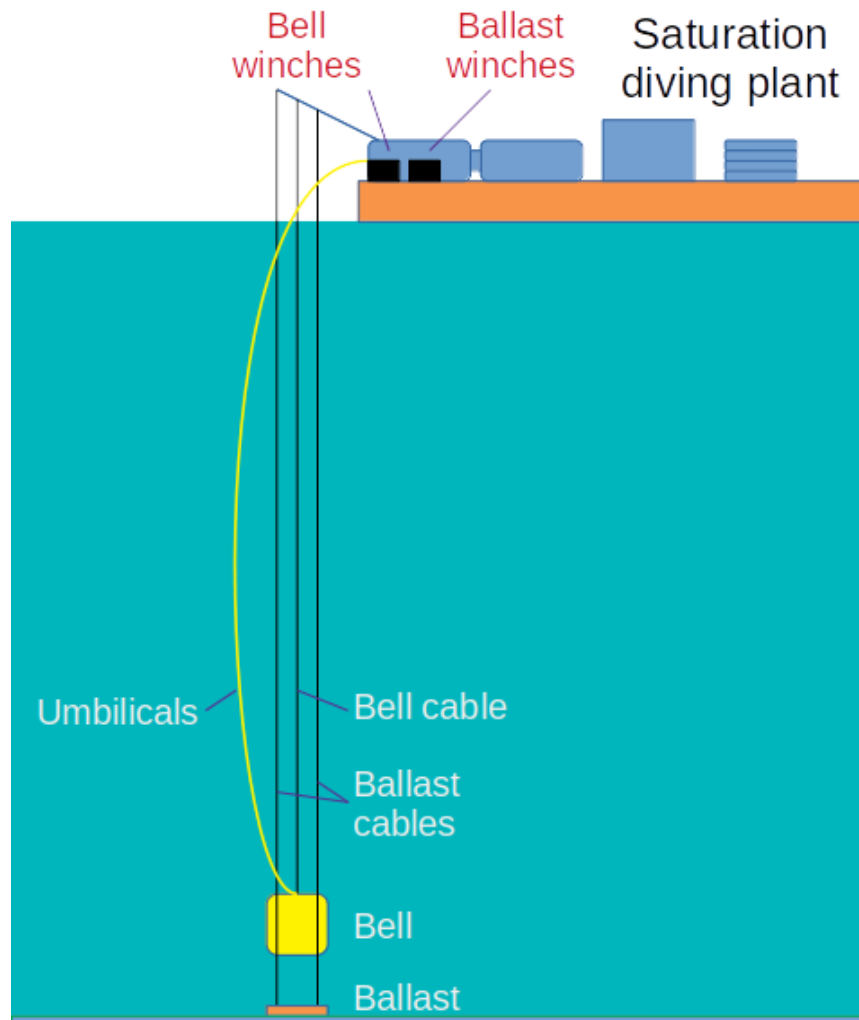


Figure 2-3. Underwater operations: ballast, bell, cables, winches and umbilicals.

The possibility to detach ballast from the inside the bell became essential after the Star Canopus accident in 1978, in which due to the damage to the cables the bell was dropped to the seabed (Limbrick, 2002). In present days it would be sufficient to unpin weights from the



inside, however, at the moment of the accident the only solution was to exit from the bell and to do it from the outside. Indeed, the divers did not manage to open the bottom hatch and died of hypothermia.

The most dangerous situation which could occur is fire on a vessel. In this case the bell could not be lifted up and divers would be blocked underwater. In some circumstance, such as permanent damage to the plant, the only hope to save the divers trapped underwater would be in case of immediate proximity of another vessel with special rescue equipment.

As was mentioned in introduction, plants of this kind utilize special gas mixtures with lower concentration of oxygen, while its exact value differs based on required depth of operation and on corresponding pressure. Often, works should be performed in some range of depths, hence, several premixed solutions with slightly different concentration of oxygen could be used. Furthermore, a back-up supplies and separate therapeutic mixture could also be present. Normally, gas supplies for the divers' suits and the main chamber are different, which allows more fine-grained control and optimization of breathing gas. Gas cylinders with the same type of mixture are assembled in "packs" with the internal pressure which could be as high as 100 bar.

Completely separate breathing system is done to support LSSs outside of the chambers, it has the same composition as normal air and is used in case of presence of gases in the control room, such as smoke.

Another aspect of plant operation is related to treatment of exhausted gases. In general, the main possibilities are to discharge it in the atmosphere, while another option is to recover it, at least partially for further reuse. Obviously, in the first case it is possible to save money on additional equipment while plant's exploitation is more expensive, while the second option is completely opposite. Considering this, utilization of both approaches to gas exhaust can be observed in industrial applications.

Similarly, to treat exhaled gases inside a plant, carbon dioxide scrubbers are normally used (Nucklock et al. 1985). In normal operations their canisters must be replaced each several hours, but this time can be reduced or increased based on specific model and work conditions. Another important procedure of removal of exceed CO<sub>2</sub> is "washing": in case of high concentration of CO<sub>2</sub> in a chamber, blowdown and exhaust valves are opened contemporaneously and the atmosphere being replaced until the concentration of a carbon dioxide is not reduced to required level.

Another important operation which must be taken into account are related to utilization of shower, toilet, food lock and material lock. Indeed, using of shower requires high energy consumption to heat a water and could impact whole plant's temperature and humidity. Meanwhile, shower and toilet drain uses existing pressure difference to draw out blackwater, so exhaust system is quite simple but its activation reduces slightly plant's internal pressure every time it's being used. Furthermore, opening of such discharge valve could be quite dangerous, so due to safety requirements it is mandatory to have at least two valves on each tube - one inside a chamber and one outside, so a member of technical assistance staff or a life-support technician (LST) outside of a chamber is required to exhaust blackwater.

Food and material locks are essential for food and object passing between external (atmospheric pressure) and internal (high pressure) parts of the plant, for example to pass instruments, spare parts or food. Locks are attached to a chamber's surface from outside and contain two hatches and two valves each. To pass an object from outside to inside few actions must be performed. First, lock's external hatch must be opened so an object can be putted inside a lock, then hatch's blowdown valve must be activated to increase the pressure inside the lock, when pressures inside the lock and the chamber are equalized internal hatch can be

opened and an object can be taken, after this internal hatch must be closed and lock's exhaust valve must be opened to reduce the pressure inside it, so external hatch can be opened again. For safety reasons all locks have special clamps/latches to prevent opening of hatches when there is a pressure difference. So each object passing requires coordinated operation of a diver inside the plant and a LST outside. Indeed, these locks are operating as small transfer under pressure chambers as illustrated in the figure below.

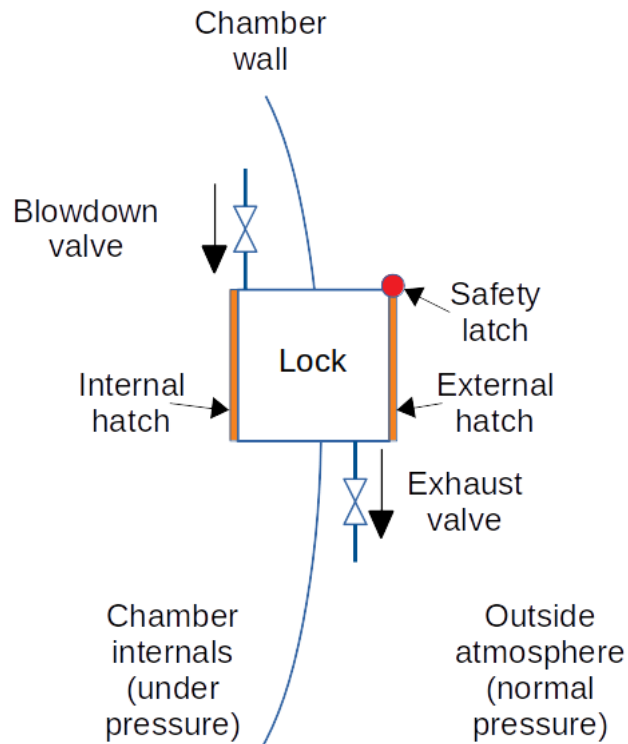


Figure 2-4. Material and food passing locks' structure.

### 2.1.1 Control System

Control of all normal and emergency operations is performed by a LSS from control room and it is done in several ways. First, using measurement instruments such as pressure gauges and gas analysers to control gas's pressure, concentrations, humidity and presence of contamination. Second way of operation's supervising is to use voice communication system with personnel inside and outside of a chamber. Third option is to check divers inside the chamber using video surveillance. In normal operations all these methods are used together to achieve redundant control and hence maximize efficiency of operation and safety level. Control room normally contains several control panels required to modify and check an internal atmosphere, communicate with staff inside chambers and technicians outside, regulate SDC depth, perform supervision. Example of a modern control panel of a hyperbaric plant is presented in the following figure.



Figure 2-5. Typical control panel of a saturation diving plant.

### 2.1.2. Control Devices, Sensors and Gas Analysers

In order to guarantee safety and efficiency of operation, it is required to have a set of precise and certified control equipment, such as flowmeters, gas analysers, pressure gauges, thermometers and hygrometers. Hereafter is presented analysis of different types of equipment typically presented in control panels, their intended purpose and principal characteristics. Indeed, these systems are essential for the saturation diving plant management and must be realistically represented in the training solution.

#### Atmosphere Monitoring Systems

One of most used devices in this kind of plant is the atmosphere monitoring system, which nowadays allows to connect also different sensors and to acquire almost any information about environmental conditions inside the plant.

#### *ANALOX*

One of widely used devices, called ANALOX, allows to connect numerous remote sensors certified for control of (Lillo & Caldwell, 2005):

- Oxygen level
- CO<sub>2</sub> concentration
- Pressure
- Temperature
- Humidity

For any of these parameters it is possible to set a range of acceptable values in order to get automatically an alert in case of dangerous values of some parameter; meanwhile the system is smart enough to recognize failure of sensors and to inform the LSS.



Figure 2-6. ANALOX Atmosphere Monitoring System.

Considering this, the training must foresee possibility not only to use such system to visualize values, but to perform also all required configurations and control. In particular, the trainee must be capable to do following procedures:

- Properly read data
- Configuration of date and time for proper reporting
- Do tests of inputs and outputs (e.g. alarm)
- Set alarm levels:
  - Low concentration of O<sub>2</sub>
  - High concentration of O<sub>2</sub>
  - Elevated concentration of CO<sub>2</sub>
  - Dangerous concentration of CO<sub>2</sub>
- Depth variation levels:
  - Pressure is too high
  - Pressure is too low

Of course, this implies that trainee is capable to estimate proper values of parameters of interest. Obviously, there is no requirement to employ this particular model of analyser, the important consideration instead is to provide possibility to become proficient with atmosphere monitoring.

### ***San Giorgio SEIN UNS 10194***

Another typically used system is San Giorgio SEIN UNS 10194, which includes a data acquisition, logging and visualization system, displaying data on a configurable touch screen. The system is universal and could be connected not only to the gas analysers, but also to propulsion system, fuel consumption sensors as well as other numerous devices equipped with CAN bus.



*Figure 2-7. Example of San Giorgio SEIN 10194 interface.*

The trainee must demonstrate capability to operate different kinds of analysers, hence, to:

- Set thresholds for following alarms:
  - Gas concentration
  - Pressure
  - Power consumption
  - Temperature
- Read data regarding atmospheric composition
- Track position of vessel
- Exhaust gas controls
- Fuel consumption and propulsion data of the vessel

### ***Polytron Drager***

In some cases, it is critical to have an additional stand-alone CO<sub>2</sub> sensor, which would reassure proper measurements of this very dangerous gas. For instance, Polytron Drager CO<sub>2</sub> detectors allow fast and accurate measurement of gas concentration. In this case operation of the device is quite tricky; indeed, such systems usually not support connection to multiple sensors and gas must be injected directly in the sensor. Considering this, a reference plant of the research project is equipped with several hoses which connect most critical chambers to the control panel; hence, in order to measure gas concentration, the LSS must connect sensor to one of the hoses, open corresponding valve and read measured value, at the next step he

or she must close the valve and disconnect the sensor, as illustrated in the figure below; the valves and corresponding hoses are labelled with numbers 57 – 64.

Usually this kind of system is connected to the synaptic computer, responsible for maintenance of log of all operations. In case of an accident and especially injuries and fatalities, this log and recordings of audio communications are main documents for the investigations (Sayer & Azzopardi, 2014)

This type of analysers is required to familiarize trainee with following procedures:

- Properly read data
- Calibration
- Configure alarm
- Connect device to dedicated hose



*Figure 2-8. Polytron Dräger CO2 Analyser and connectors to the chambers.*

### ***Flow meters***

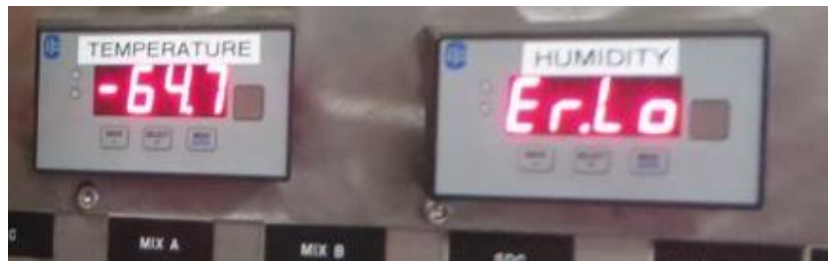
In case of emergency it could be necessary to blow oxygen directly to the chamber, in this situation it is essential to monitor the flow rate of gas. This task could be done by simple gas flow meters; 4 devices and corresponding valves as presented in the figure below.



*Figure 2-9. Gas flow meter to monitor pure oxygen flow.*

### ***Temperature and humidity sensors***

One of the simplest yet critical devices for plant operation are thermometers and hygrometers. Indeed, considering high pressure inside the plant the human beings inside become very sensitive even to small variations of the temperature. Considering this, at least principal parts of the plant must be equipped with such sensors; in the figure below it is presented a pair of such sensors.



*Figure 2-10. Temperature and humidity sensors connected to the living chamber of the reference plant.*

### ***Pressure gauges***

Considering possible blackouts and malfunctions, it is common practice to have installed traditional analogical pressure gauges connected directly to the chambers, trunks, bell and divers' umbilicals. Indeed, the most used way to measure depth of operation of divers is by controlling the pressure. In order to provide fine granularity of readings in case of initial stage of compression or final stage of decompression, it is possible to have additional gauges with lower operational range. In such case the gauge is connected only when required. Example of gauges in the reference plant of this research project is illustrated below.



Figure 2-11. Pressure gauges in the control room.

### Auxiliary monitoring systems

Apart from monitoring of the atmosphere it is crucial to acquire telemetry from the whole plant in order to prevent possible malfunctions. For example, control room could include systems to monitor power supply, check status of different main and auxiliary sub-systems etc.

### Video supervision

Saturation diving plants are characterized by very limited possibility of visual control. Indeed, most of the time divers live in closed locks with only a couple of small portholes. Considering this, internal video supervision is critical in order to evaluate state of the divers, check for emergencies and supervise work activities. For this reason, modern plants are equipped with numerous cameras installed inside chambers as well as on the bell and constantly transmit video feed to the LSS. For example, the reference plant has multiple screens connected to the video surveillance system to guarantee contemporary view of all critical parts of the plant.





*Figure 2-12. Video surveillance screens (turned off) in the control room.*

### **Atmosphere regulation**

The principal way of control of the atmospheric conditions inside the plant is by means of regulation of blowdown and exhaust of gases. Indeed, it allows to control pressure, perform cleaning (replacement) of atmosphere and compensate major part of leakages.

In the saturation diving plants the number of valves is very high. For example, each chamber and trunk has its blowdown and exhaust valve; all gas cylinder packs with different gas mixtures are connected to the manifold of the main panel, while their usage is controlled by valves. Furthermore, all measurement equipment (gauges, gas analysers, flow meters) is equipped with valves. In particular, the reference plant has almost 150 different kind of valves on its control panel, with small part of them illustrated below.



*Figure 2-13. Gas pipes connected to the manifold (red) and corresponding valves.*

Depending on task a needle valve (high precision regulation) or a ball valve (low precision regulation) could be used.

Typically, gas cylinders contain gas mixture at pressure up to 100 bars which goes far beyond acceptable range of internals of a hyperbaric plant. Furthermore, handling of such pressure would require complex and expensive gas distribution system while risk of failure would be elevated. Considering this, the plants are equipped with back pressure regulator, which allow to introduce pressure drop between gas cylinders and other parts of the plant. Indeed, by setting the regulator it is possible to reduce original pressure down to required 15-20 bars.

However, in some particular case this value could be elevated. For example, in case of damage of the chamber and consequent leakage of gas, a significant pressure drop inside could be observed. Considering that fast decompression is one of the worst thing that could happen to the diver, the main goal of an LSS would be to compensate the drop: until personnel is evacuated or until leakage is identified and stopped. In this case, normal gas flow could be not sufficient to compensate the drop; hence, LSS has possibility to increase temporary the pressure and to augment drastically blowdown. The pressure regulators are resented in the following.



*Figure 2-14. Pressure regulators with pairs of gauges.*

One of the forms of control of atmospheric conditions is the Hyperbaric Conditioning Unit (HCU). This system is required to heat and cool the atmosphere inside, making living and working conditions acceptable. The LSS is required only to set up the desired temperature and the system would take care of its automatic maintenance.

Another important system related to emergency operation is called BIBS (Built-in Breathing System). This system is typically controlled by means of dedicated valves and flow meters and is required to deploy additional, oxygen-rich, breath gas mixture, which is used by personnel inside by wearing special masks.

### **Communications**

Phone is the most efficient way to interact with divers inside the plant. Indeed, most critical parts of the plant are equipped with phones. In case of malfunction of phones, the LSS would be constrained to use one of the auxiliary systems for communication, such as an emergency radio. Both systems are presented in the figure below.



*Figure 2-15. Phone (in the middle) and registering device (below).*

Considering low possibility to monitor state of the divers and consequently elevated risk of emergencies, the plants are normally equipped with always on sound transmission system; hence, microphone installed in the living room transmits signal directly to the outside part of the plant. This functionality allows to the staff to immediately identify possible problems based on sounds or on their absence.

### **Other Controls**

In order to operate properly saturation diving plant require several auxiliary systems. For example, in order to detect displacement of the host vessel a positioning system is required. Indeed, considering that the plant is floating while the bell is connected to the seabed by means of ballasts, significant water currents could cause its damage or even loss. In such case return of the divers to the surface could be problematic or even impossible.

Another important system related to the diving supervision is the underwater lighting. Indeed, natural light does not arrive at the operational depths in any detectable quantity, hence, artificial lights are essential to allow divers to perform their work.

Obviously, proper training and experience are required to be allowed to operate this kind of plants.

## 2.2. Saturation Diving Procedures

In the previous sections it is presented a set of equipment required to perform safely and efficiency various operations underwater. Another essential part of this kind of operations are procedures, both normal and emergency ones. Among normal operations it is possible define:

- Compression
- Decompression
- Routine operations under pressure, such as cleaning
- SDC operation
- Material and food passing
- Shower and toilet usage

Emergency operations include but not limited to:

- Evacuation
- Blackout
- Pressure loss
- Dangerous gas concentration variation
- Emergency entry of personnel
- Chamber pollution

In the following are presented principal procedures related to each of this scenarios.

### 2.2.1. Compression and Decompression

Operation of the plant and work shift always starts from the checkout of equipment with consequent compression procedure. During the compression it is necessary to have a pause after initial increment of pressure; this pause allows to ensure that there are no gas losses while the pressure is still relatively low and abortion is relatively simple. Slow and gradual compression is required not only to replace normal breathing atmosphere, but to change gas composition also in tissues of human body.

A diver's blood and tissues take in additional nitrogen (or helium) from the lungs during saturation in modified atmosphere. If a pressure rises too fast, this excess gas would separate from the solution and form bubbles. These bubbles produce mechanical and biochemical effects that lead to a condition known as decompression sickness.

Typically, compression rate depends on the depth and summarized in the following table; the presented values are approximate and could vary according to local regulations and norms.

*Table 2-1. Maximum compression rates.*

Depth, m	Compression rate, m/minute
0 - 20	< 9
20 - 80	< 3
80 - 230	< 0.9
> 230	< 0.6

For example, if target depth is 200m and compression rate is the maximum one, the time to achieve it would be

$$t = (20 - 0)9 + (80 - 20)3 + (200 - 80)0.9 = 2 \text{ hours } 36 \text{ minutes}$$

Obviously, in real operation the compression rate is lower and whole procedure could last up to 1 day.

Decompression phase in one of most dangerous normal operations and is done with particular attention. Indeed, while human body could adapt to relatively fast saturation, desaturation requires much more time. Typical decompression rates are presented in the following table.

*Table 2-2. Maximum decompression rates.*

Depth, m	Decompression rate, m/hour
0 - 15	< 0.9
15 - 30	< 1.2
30 - 60	< 1.5
> 60	< 1.8

For instance, decompression after work on 200m depth would require at least

$$t = (200 - 60)1.8 + (60 - 30)1.5 + (30 - 15)1.2 + (15 - 0)0.9 = 127 \text{ hours}$$

Hence, at least 5 days are necessary just to perform decompression. Furthermore, additional day of medical surveillance is often required to ensure absence of negative consequences for health of divers.

### 2.2.2. Routine Operations

In some cases, chamber demonstrate excessive presence of CO<sub>2</sub> or other undesired gases and their mixtures. In such situations it is required to perform one of following operations:

- Air cleaning
- CO<sub>2</sub> scrubber cartridge replacement

In the first case the LSS opens contemporary blowdown and exhaust valves of a chamber, creating gas flow while maintaining constant pressure.

The second operation requires intervention from the divers inside the plant. Indeed, in order to remove CO<sub>2</sub> from the internal atmosphere special scrubbers are used to filter air and capture undesired gas. This operation is done by continuous filtering of air by means of replaceable cartridges with typical duration of 8 hours. Hence, 3 times a day divers are requested to substitute them with new one. Failure to do this operation would cause growth of CO<sub>2</sub> concentration, which must be taken into account in the simulation.

### 2.2.3. SDC Operation

Operation of the bell requires a lot of attention from the LSS. Indeed, it is required to connect or disconnect a part of the plant, ensure absence of losses, check pressures, control winches and coordinate operations of divers and technical personnel. Indeed, this routine procedure

is potentially most dangerous part of the normal plant operation. For this reason, there are several typical requirements in order to perform this operation safely:

- The bell could be clamped and unclamped only by the command of the diving supervisor and no-one else.
- Transfer chamber of the plant must be free of personnel with hatches closed.
- Bell's hatch and corresponding plant's counterpart must be opened for as small as possible period.
- Stop of all operations in case of any doubt.

Following set of steps is typically required to lock on the bell:

- When the bell has been recovered on deck the diving supervisor instructs crew to lock the bell to the plant and to secure the safety clamp to prevent undocking caused by possible pressure difference.
- Diving supervisor ensures that trunk's exhaust valves are closed and informs divers in this regard
- Diving supervisor or the LSS pressurize the trunk to a minimal pressure, e.g. equivalent to that one of 1 meter of seawater MSW, to ensure that there are no losses.
- Diving supervisor or the LSS pressurize the trunk to part of the required pressure conducting short pressure test.
- Pressurization continues until value in trunk and in the bell are almost the same, after the additional short pause for checks, the divers are instructed to equalize pressures using dedicated valve

The procedure to lock-off the bell is quite similar:

- When divers are going in the bell they are instructed to close hatch of transfer chamber and of the bell itself. The supervisor informs divers about start of lock-off.
- The diving supervisor or the LSS vent the trunk to a couple of MSW shallower than original depth/pressure and check that there are no leakages.
- The exhaust continues until pressure in the trunk is equal to the atmospheric one. At the end of this operation local trunk vents could be opened to guarantee equilibrium.
- The diving supervisor orders to unlock the clamp.

As mentioned, this part of operation is performed very often, however, single error could cause serious consequences, including death of personnel inside. For instance, in 1983 an explosive decompression of diving bell of the Byford Dolphin oil rig occurred (Giertsen et al., 1988). In this case, for uncertain reasons, the clamp of the bell was opened right after divers left the bell to the transfer chamber but before the trunk hatch was closed. The internal pressure in the chambers was circa 9 bars at that moment, hence, the air violently pushed the bell away killing one of technicians and seriously injuring another. All 4 divers presented in the chamber at that moment were instantly killed.

In another case which happened in 1974, two divers died after weights of the bells were suddenly detached; this event caused fast and uncontrolled lift of the bell from the depth of 100m, with the divers dragged by the umbilicals (Limbrick, 2002). Both divers died due to fast decompression.

In the simulator part of these actions could be played by the instructor (e.g. diving supervisor, technician staff). The trainee is required to follow procedure, pressurize and check chambers and trucks, monitor for leakages or other anomalies as well as react to possible emergencies.

## 2.2.4. Object Passing

Work shift of a saturation diving plant could last multiple weeks, hence, it is necessary to be able to supply to the divers various objects, such as:

- food
- materials (e.g. replacement for CO<sub>2</sub> scrubbers)
- instruments

These operations are normally done using one or multiple locks, as anticipated in previous chapter. The sequence of operations to pass object is following:

- LSS informs a technical operator about start of object passing
- Operator opens external hatch of the lock, which is possible because pressure inside should be equal to the external one when not used
- Operator puts inside required objects and closes the hatch
- LSS notifies divers that they can pressure up the lock by opening a valve to equalize pressures inside the lock and in the chamber
- The internal hatch opens while pressures are equal, while external hatch is blocked
- Divers take material and close internal hatch and the valve
- LSS informs operator to depressurize the lock

## 2.2.5. Shower and Toilet Usage

One of everyday operations performed by divers is utilization of toilet and shower. In case of saturation diving plant such trivial in everyday life operation becomes quite complex and require assistance of external technical personnel. Indeed, discharge of water after toiled usage is done by pressure difference, hence, a valve which connects internal and external parts of the plant must be opened. In particular, following steps are required to accomplish this procedure:

- Diver informs LSS about his intention to use toilet and moves to dedicated compartment
- LSS monitors compartment to detect any possible anomaly in behaviour
- Diver communicates to LSS necessity to exhaust blackwater
- LSS contacts technical personnel which opens corresponding valve

Motivation to employ such complex procedure is caused by a safety accident in the past, when divers were enabled to exhaust blackwater by opening valve from inside of the plant; in particular, in one case a diver had severe injuries after opening the valve while sitting on the toilet, hence, tapping by his body a hole with huge pressure difference inside and outside. It is important to mention that utilization of both shower and toilet facilities impacts state of the atmosphere by increasing humidity and dropping the pressure. Evidently, such processes must be presented in the simulation.

## 2.2.6. Evacuation

In some cases, the plant could not be used anymore due to safety reasons and personnel must be evacuated. Normally, it happens only in 2 cases:

- Fire on vessel
- Sinking of the vessel



It is important to note that fire inside the chamber is barely possible due to very low oxygen concentration. However, fire heats the chamber making presence there impossible; in the same time, fire and heat could damage HCU causing injection of smoke in the chamber. In any case this operation is dangerous by itself and is performed only in critical situations. Typical steps are following:

- LSS declares beginning of evacuation
- Divers go to the escape trunk leading to the Hyperbaric Rescue Chamber (HRC)
- LSS rises the pressure inside trunk so it can be opened
- Divers proceed in the HRC, the last one closes the hatch the trunk and of HRC itself
- LSS checks that hatches are closed and depressurizes the trunk. It is essential to unlock the latch of HRC and to prevent situation in which excessive pressure in the trunk 'shoots' the HRC.
- Personnel of the plant unlocks HRC and emerges it in water

The rescue chamber has its internal supplies, typically sufficient for 1 day of autonomy, while pressure and other parameters are controlled directly by divers using internal valves and gauges. The HRC continues to float on the surface until rescue ship lifts it up and attaches it to another hyperbaric plant for controlled decompression.

### 2.2.7. **Blackout**

Nowadays power supplies are quite reliable, however, in some cases their malfunction and consequent blackout could occur. In this case most of measurement equipment, winches and video surveillance system becomes unavailable, creating risk for divers. Considering this, the first step is to connect a backup power supply instead of the principal one. The communication with divers in this case is done visually through porthole or by using acoustic signals by beating surface of the chamber.

In the simulation blackout would appear as sudden shutdown of video feeds, analysers and part of communication system. Considering this, actions of trainee would include communication with personnel on site in order to restore power supply. Meanwhile, emergency communication systems to contact divers could be used. Obviously, replies of trainee and divers would be provided by the trainer.

### 2.2.8. **Pressure Loss**

Sudden loss of pressure is one of more common scenarios which is typically caused by following reasons:

- damage to portholes
- cutting of a gas pipe

In any case divers inside the plant note this situation immediately by ringing in ears, while LSS sees it on pressure gauges and possibly by means of alarm of atmospheric monitoring system. When the loss occur the first actions should be:

- compensate loss by opening blowdown valves and acting on pressure regulators in order to improve as much as possible the gas flow
- move personnel in other locks

In 1975 two divers died in hyperbaric diving plant in Waage Drill II accident. In this situation a gas leakage was detected between the bell and the transfer chamber (Scotland FAI, 1977). The life support supervisor correctly instructed the divers to move to a secure location in the

living chamber, however, after he misread the pressure value confusing it with another pressure gauge and supposed that the living chamber is subjected to leakage as well. After this, LSS tried to compensate pressure loss by opening blowdown in the chamber but continued to monitor pressure variation on wrong gauge. During this procedure he accidentally increased pressure two times respect the initial value, causing temperature rise almost up to 50°C, which killed two divers after two hours of hyperthermia.

This situation is included in the simulation, in particular, the trainer has possibility to open a valve between some locks and external atmosphere, creating pressure drop. In the same time trainee tries to fix the problem by opening blowdown and instructing divers to move in another lock. Finally, trainee contacts personnel of the plant (played by the trainer) in order to try to close different valves. At some point trainer could decide or not to stop the loss by closing the valve.

### **2.2.9. Dangerous Variations of Gas Concentrations and Stratification**

Physical activity of divers and malfunction of scrubbers lead sometime to dangerous variation of gas concentration in chamber, for example to the lack of oxygen or the excess of CO<sub>2</sub>. Such cases must be carefully monitored by the LSS.

Another problem which occurs in chambers is stratification of gases. Indeed, due to particular composition of the atmosphere, gas mixture tends to separate creating separate layers of oxygen and inert gas. This situation leads to an interesting but dangerous situation in which divers, which are typically sleep in two 'floors', are contemporary subjected to hyperoxia and hypoxia, based on their elevation from the bottom of the chamber. This problem is quite rare, especially considering movements of air caused by divers and scrubbers, however it should be taken into account.

### **2.2.10. Emergency Entry of Personnel**

Sometime diver gets hurt and even if there is always at least one diver inside who is trained in medical assistance, professional medical intervention could be required. Considering that decompression is very slow and could be especially dangerous to the sick person, a medic could be required to enter the plant by doing fast compression. In the simulation this operation is conducted as normal compression of one of chambers of the plant.

### **2.2.11. Chamber pollution**

There are different ways for a dangerous substance to enter the chamber. For example, it could be caused by divers which are turning from work shift with contaminated suits or instruments; otherwise, malfunction of HCU could cause injection of oil mist.

In this situation the divers should be requested to move in another lock, while atmosphere cleaning is performed until the problem is fixed.

### 2.2.12. Emergency Operation Considerations

There are several different emergency situations which could occur in such kind of plants, but gas leakage is most frequent and requires more attention. For example, it can be caused by following main factors: breaking of a hatch or cutting of a tube. In any case, the plant start to lose pressure at very dangerous rate and the main objective of all personnel is to seal it and to restore the normal pressure. In such situation the divers inside must wear BIBS, while LSS opens all blowdown valves to provide maximum gas flow controlling if the pressure increases or not. After these operations divers are instructed to locate a leakage; for example, in case of a damaged pipe, LSS and divers open and close valves to see when leakage starts and stops. As the last option evacuation can be performed.

Another important problem is blackout; indeed, even if some of equipment is analogical or has analogical backups, normal operation of the plant cannot be continued, hence, in some cases even complete evacuation could be necessary. In case of a blackout LSS must instruct technicians to connect backup power supply instead of the main one and the criticality is the fact that there is no other possibility to restore power supply. If failure persists, divers must be evacuated from the plant. It is important to mention that in case of missing power it is impossible to use main communication systems or supervise execution of instructions by divers through video cameras. In case none of existing communication systems is operational, tapping code must be used.

In some situations, emergency could be declared erroneously. For instance, according to IMCA Safety Flash of 20/19, a crew member accidentally pressed emergency stop buttons on oil lube pumps which caused immediate start of recovery of divers to the surface. Investigation found that the emergency stop buttons were missing protective covers and were placed in a narrow passage.

Other dangerous situations which could lead to evacuation are sinking of the barge/ship or fire on a ship.

Evacuation could be inevitable in case of persistent problem with the plant; in this case a hyperbaric rescue chamber is used. An HRC is connected to other parts of the plant by an escape trunk, which is always closed for safety reasons. To be sure that an escape trunk's hatch is closed, pressure inside it maintained at lower level than the pressure inside other chambers, and in case of evacuation is must be raised so the hatch can be opened. After this procedure divers can evacuate themselves in a HRC, last diver closes the hatch, escape trunk's relative pressure is reduced to zero and a HRC is released from the plant. For safety reasons a HRC and SDC have special clamps to prevent undocking when the relative pressure is high to avoid high speed and potentially lethal ejection. Indeed, complete gas exhaust from the trunk is required to prevent shooting of HRC. HRC have autonomous life support system which can operate typically for one day and during this time another ship with a rescue chamber must be available to lift up and rescue divers. Photo of HRC of the reference plant is shown below.



*Figure 2-16. Hyperbaric Rescue Chamber (orange) on board.*

Finally, saturation diving plants are equipped with multiple power supplies in order to minimize probability of complete blackout. Indeed, in such case not only sensors and winches would stop working, but also heating system, which could be very dangerous especially for the divers underwater.

### 2.3. Underwater Medicine

The harsh environment could create various problems to the health of human beings and in case of improper preparation or work coordination it could lead to severe injuries and fatalities. Indeed, apart from accidents, the ambient conditions are the main challenge of the personnel and affect divers by following means:

- Temperature
- Pressure
- Gas composition

Based on these considerations it is useful to refer to main analyses of different phenomena and effects available in technical and scientific literature (United States Department of the Navy, 2016; Evan, 2005; Fisher et al., 2011).

One of most complete and exhaustive documents in the field is the US Navy Diving Manual that is a reference document for the whole sector; furthermore, it has detailed explanation of health and safety issues which are essential for development of the simulator and for training of LSS and LST, and this manual contains a lot of information regarding underwater physiology and describes situations and symptoms of different diving disorders. While some problems are caused by specific events, such as vertigo could be caused by fast pressure change rate, there are also problems which are caused by combination of different factors without clearly identified cause. Obviously, such problems are less important to training of LSS even if still must be taken into consideration. One of this problem is so-called "diver's hand" which is illustrated below (Ahlen et al., 1998).



*Figure 2-17 Diver's hand disorder*

In the following, there is presented analysis of medical conditions especially relevant for the training of LSS; each case includes description, symptoms, conditions which cause it, parameters required to be tracked in order to simulate properly appearance of symptoms as well as counter actions which LSS must do in order to fix the problem. These medical conditions could occur in case of emergencies or even during normal operation and must be realistically represented in the simulator in order to guarantee quality of training.

### 2.3.1. Barotrauma

Fast pressure variation is one of main causes on injures in the field of diving; indeed, external pressure changes, especially dangerous in case of decompression are known to be one of principal factors in accidents among divers (Lundgren, 1965). In case of rising pressure the air in the body has much lower pressure respect to the external one and cannot be compensated by natural mechanisms, while in case of decreasing pressure it is caused by impossibility of the gas to leave cavities in time.

Typical symptoms are:

- ear ringing and pain
- pain in cheekbones area
- blood in the nose and in eyes
- dental pain

The problem is normally reported to LSS by divers. In order to evaluate occurrence of symptoms it is necessary to monitor constantly pressure in order to measure its variation in time. While the exact value of pressure variation rate which causes problems depends on individual physiological reaction, in general, the values of acceptable compression and decompression rates provided previously could be used to estimate them. From the LSS in order to stop the symptoms or at least to limit damage it is required to fix pressure at constant value.

During the normal operation of the plant it is possible to have temporary exceeds in pressure variation rate which could cause some mild symptoms which disappear when situation is normalized. However, especially during emergencies, barotrauma could be much more serious and chirurgical intervention or even lifetime care could be required (Becker & Parell, 2001; Tetzloff et al., 1997).

In the simulated scenario, based on level of details of 3D graphics, it could be possible to include also visual representation of barotrauma; for instance, Barreiros et al (2017) provide following illustration of barotrauma



*Figure 2-18 Barotrauma hemorrhage*

Another consequence of fast decompression which is sometime observer in the field of diving is Cutis marmorata, or marble skin. Following image illustrates this disorder (Smithius et al., 2016).



*Figure 2-19 Marble skin*

### 2.3.2. Vertigo

The alternobaric vertigo is caused usually by a difference in hydrostatic pressure between the two cavities of the middle ear, which causes an imbalance between the vestibular systems of the two sides. Indeed, vertigo is one of possible symptoms of barotrauma. However, it is also a symptom of other health issues, such as Arterial Gas Embolism (AGE), caloric stimulation and gas narcosis, hence, in case of communication of vertigo symptoms by the diver

additional attention from personnel could be required in order to determine source of the problem (Edmonds, 1971). When two vestibular systems do not operate in equilibrium sensations of vertigo appear at times accompanied by nausea and vomiting. Hence, in order to foresee symptoms, it is essential to track pressure variations. The symptoms are:

- Dizziness
- Nausea
- Vomiting

In this situation divers, as well as their virtual counterparts, communicate to the LSS existing problem.

### 2.3.3. Hyperoxia and Hypoxia

problems related to oxygen concentration could be caused by its insufficient or excessive values. For example, when the pressure is too low (hypoxia) it is possible to see following symptoms:

- Cerebral Effects
  - itching and redness of the hands and feet
  - twitching of the lips
  - dizziness
  - nausea
  - drowsiness
  - convulsions
  - unconsciousness
- Pulmonary effects
  - difficulty in breathing
  - cough and shortness of breath

Usually persons are able to communicate presence of such problems to the supervisors. In case of too high concentration (hyperoxia):

- Uncontrolled convulsive movements similar to epileptic spasms
- Tic

In this case it is important to note that diver would most probably fail to communicate problem to the supervisor. In both cases it is important to keep track on oxygen concentration.

It is possible to distinguish different types of oxygen toxicity:

- Lungs toxicity. When oxygen partial pressure is higher than 0.5 bar it could cause first signs of pulmonary toxicity (Bitterman, 2009). Considering this, the oxygen partial pressure in saturation diving is usually maintained close but lower than this limit.
- Central nervous system toxicity. If oxygen partial pressure exceeds 1.5 bar even for several minutes, diver's central nervous system would cause seizure and similar reactions (Smerz, 2004).

Hypoxia, contrary, appears when oxygen partial pressure is too low, usually if it is lower than 0,13 bar (Baillie & Simpson, 2007). In the simulation it could be possible to introduce visual effects related to critical level of hypoxia, in particular, by changing skin colour to make it light-blue as occurs in case of cyanosis, as illustrated in the following (Yassin & Soliman, 2017).





*Figure 2-20 Anterior hand comparison between cyanosis suffering person (left) and his brother (right)*

#### 2.3.4. CO<sub>2</sub> Poisoning

Sometime, in case of insufficient filtering of CO<sub>2</sub>, its concentration in chamber could rise to a dangerous value. Usually the symptoms are:

- Breathing difficulties (since the beginning)
- Respiratory spasms (after several minutes)
- Loss of consciousness and fainting (after 5 minutes)

Obviously, the symptoms are triggered by CO<sub>2</sub> concentration, which should be carefully logged in the simulator. Usually divers demonstrate spasms and communicate problem to the LSS, which in its turn required to replace gas by cleaning (contemporary blowdown and exhaust). However, it could give diver little or no warning until severe symptoms appear.

CO<sub>2</sub> concentration is usually expressed in parts per million (ppm) and should not exceed 5000ppm (surface equivalent) in case of long time operation (NAVSEA, 2013); however, corrective actions are required even if value is higher than 500ppm. In the following approximate acceptable levels of CO<sub>2</sub> suitable for long exposure at different depths are presented.

Table 2-3. Acceptable CO<sub>2</sub> concentration at different depths of operation.

Meters of Sea Water	CO <sub>2</sub> (ppm)
50	800
100	450
150	300
200	250

### 2.3.5. Nitrogen Narcosis

As mentioned, in some situations the gas mixture stratifies inside chamber; in this situation divers have risk to breathe elevated concentration of inert gas (Nitrogen, if used) which affect the nervous system and the psychomotor capabilities (Petri, 2003). The typical symptoms are:

- Small tics and convulsive phenomena
- Sense of intense well-being
- Loss of judgment skills
- Lack of coordination
- Amnesia
- Unconsciousness

Usually, gas analysers cannot detect gas stratification, so constant monitoring of situation inside the plant in order to detect it on video is required. The impact of this problem on simulation could be negligible, while the symptoms could be triggered manually by the trainer.; it is important to note that the reference plant uses Heliox mixture, hence risk of nitrogen narcosis is irrelevant for the original plant.

### 2.3.6. Hypothermia and Hyperthermia

Physiologically human body requires certain range of operation to function properly. Overheating and over-cooling depends on multiple factors apart from temperature itself, such as humidity, pressure and individual characteristics. Considering this it could be pretty difficult to estimate at which external temperature diver could start to demonstrate certain symptoms; this events indeed could be triggered by the trainer in the simulator. However, there are certain ranges of body core temperatures which must be taken into consideration when defining operational limits. In the following table symptoms of hypothermia at different body core temperatures is presented (Davis, 1979).

*Table 2-4. Acceptable body core temperatures*

Body core temperature, °C	Symptoms
35 – 36	Shivering, feeling of cold
32 – 35	Difficulty of concentration and speech, hallucinations
30 – 32	Coma
< 30	Unconsciousness and death

A person is considered to have developed hyperthermia when the body core temperature rises 1°C above normal (37°C). The maximum core temperature considered safe is 39°C.

## 2.4. Non-Verbal Communication

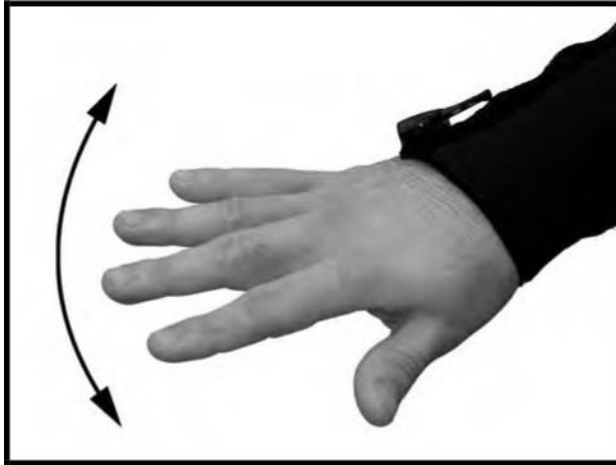
Main way of communication with divers inside the hyperbaric plant is by voice. Indeed, in such case it is quite easy to describe problem or necessity, coordinate operations and tasks; voice communication is done by means of phones. However, in case of malfunction or emergency other types of communication are used, in particular, by hand signals, lights and tap codes and even pull (pulling cables or buoys). Hereafter are described different forms of communication of particular interest to the training of LSS.

### 2.4.1. Hand Signals

In the field of underwater diving there are used many hand gestures, which are essential for coordination of operations and mitigation of emergencies. Indeed, in such environments it is quite common to have no possibility for verbal communication, at the same time, it allows to handle better malfunctions of communication equipment. Some of these gestures could be used also in simulation of hyperbaric chamber internals, allowing to make visual representation of the plant much more realistic. However, it is important to note, that while some of hand signals are regulated by organization or authorities, most of gestures are defined by teams of divers. For example, Recreational Scuba Training Council (RSTC, 2005) defines following hand signals which could be used to communicate to LSS about problems.



*Figure 2-21 Danger signal*



*Figure 2-22 Something is wrong hand signal*

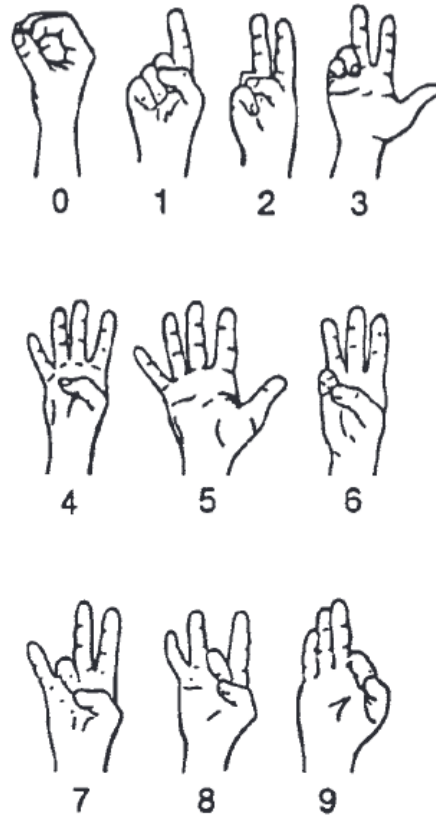


*Figure 2-23 Ear not clearing or trouble equalizing pressure signal*



*Figure 2-24 I am cold signal*

According to the US Navy Diving Manual, following gestures must be used for numbers; based on level of detail of diver 3D models, these signs could be useful also in evaluation of capability of trainee to fast understand signs.



*Figure 2-25 Hand signals in SCUBA diving*

Furthermore, other common but not official gestures could be introduced; for example, a common way to indicate nitrogen narcosis is by pointing a finger to the head and do a swirling motions with the hand.

### 2.4.2. Light Signals

In addition to hand signals it is often necessary to employ flashlight in communication. Indeed, while in some cases visibility could be so low that gestures are not visible at all, while in another cases the light source could be used to make previously described hand gestures more visible. In particular, following main light signals are used in the field of diving to indicate normal state ("ok"), required attention or emergency (Prosser & Grey, 1990).

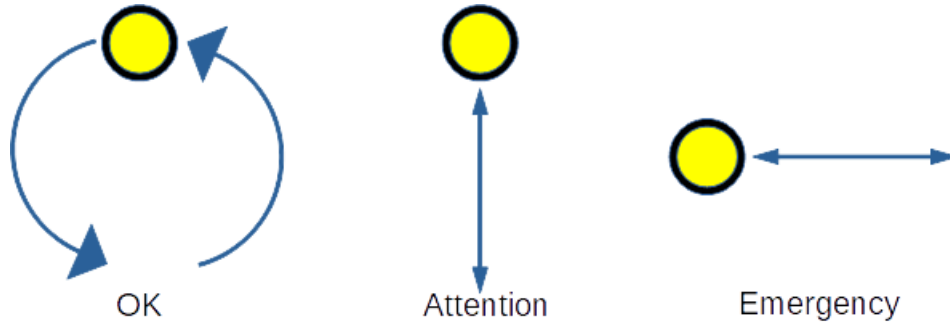


Figure 2-26 Principal flashlight signals

### 2.4.3. Tapping Code

In some cases, a universal tapping code is used for communication. For example, when a bell is retrieved by a rescue ship it could be employed to coordinate operation with the persons inside it. In case of the LSS training, tapping code acoustic signals could be used for simulation of blackout and for corresponding training and evaluation of persons. Hereafter is present a list of common bell emergency tapping codes (IMO, 1985).

Code	Situation
3 3 3	Communication opening procedure
1	Yes
3	No
2 2	Request to repeat
2	Stop
5	Have you got a seal?
6	Stand by to be pulled
1 2 1 2	Get ready to open your hatch
2 3 2 3	Not release ballast
4 4	Release ballasts in 30 minutes
1 2 3	Increase pressure
3 3 3	Communication closing procedure

### **3. State of the Art in Simulation for Training on Plants**

At this moment almost all life-support supervisor training courses are carried out on real hyperbaric plants without any person inside. This approach has some obvious constraints. First, hyperbaric chambers most of the time are in operation and they are often in distant parts of the world. Second, studying on a real chamber in normal conditions can not include preparation in handling of emergency situations, but only regular ones. Third, is that each step of trainee must be controlled by an instructor to prevent damage of the expensive and specially certified equipment.

Considering this, the replacement of a real system by a simulator guarantees several advantages, such as costs' reduction, increase safety and possibility to repeat same scenario many times which is impossible to do in the real world. Usage of simulators in marine industry continues to grow, and they are being used for many purposes, such as mission planning, development, evaluation of procedures, risk assessment and in training which is the most interesting scope.

Simulators of the chambers are widely used in the medical field and allow to introduce training scenarios which could not be performed in the real world (Gaba, 2004). Indeed, simulator can replace real equipment during a training process, avoiding costs related to plant's or machine's idle and possible damage caused by inexperienced personnel. Considering this, IMCA (International Marine Contractors Association) published few versions of "Guidance on the Use of Simulators" from 2010 which allows to benefit from advantages provided by the simulation. In the following, several examples of simulation are provided. It should be stated that in the specific sector of training for modified atmosphere environments there applications also in other sectors that we are going to mention dealing with space missions.

In addition, nowadays, there are new opportunities provided by technologies to use Modeling and Simulation within different kind of Plants and Environments; a very good example is provided by the use of Virtual and Augmented Reality (VR & AR) able to create immersive and interactive frameworks; it is evident that the availability of dynamic simulation provides major advantage to these techniques creating an interactive realistic virtual world able to evolve and react to user actions; in this sense there are interesting researches ongoing that it was possible to investigate during this thesis as well as developments for testing related capabilities in specific industrial plant applications. Most of the cases analyzed and developed are not strictly related to Hyperbaric Chambers, therefore the concept are applied to equipment, instruments and machines that could be easily readapted for this sector and represent a step forward for further innovation in this sector. From this point of view it is interesting to outline that the combined use of VR & AR is currently defined as XR (eXtended Reality) and represents any kind of mix among these two technological solutions; in facts while VR is mostly used for training and presenting results, AR is very useful for support and service of equipment as well as for remote maintenance. Sometimes by combining these two approaches it turns possible to create a common synthetic environment that could be applied to different uses over the same plant or control system as it is expected to be done soon in the sector of hyperbaric plants.

#### **3.1. Simulators for LSS Training**

Nowadays, simulation is actively used in field of underwater operations for different purposes, such as training of personnel, evaluation of risks, development of procedures and operations as well as familiarization and demonstrations. Hereafter, analysis of several related simulation-based systems is presented.



### 3.1.1. DSS-100

Currently, considering difficulty of development and critical issues of such specific sector as saturation diving, only several IMCA certified simulator exist. One of them is called DSS-100 and produced by CKAS Mechatronics from Australia (CKAS).

The DSS-100 can simulate different aspects of hyperbaric chamber, such as activity of its life-support system and another aspect related to immersions and bell operation. Using its control panel, it's possible to manage many parts of a simulated plant: gas supply system, heating system, dynamic positioning system, rescue system. All main functions of a real control panel are simulated, such as gas analyser to control oxygen and CO<sub>2</sub> level, digital or analogic pneumofathometers, communication and video surveillance systems. The simulator supports different scenarios and an instructor can change parameters of simulation in real-time in any moment.

All presented on the simulator's panel valves are electronic, the simulator doesn't use any gas. The panel has an alarm connected to dynamic positioning system (DP) of a ship. To analyse concentrations of gas it is possible to connect gas analyser to nozzles, connected to different parts of the simulated plant.

Voice communications are performed with instructor using a scrambler. Video feeds which in a real panel are obtained from a video surveillance system, are simulated. Another important part is the logging system, which allows to register operator's action.

SimCor calculates in the real time gas equations, partial pressures, thermodynamic parameters and another necessary for simulation values. The simulator has capability to operate not only in a real-time mode, but also in the fast-time and the slow-time. Technologies which were used to create the simulator originate from aeronautical industry.

Physically the simulator is placed in a 20' container with 3 chambers - 2 with control panels and one with the operator's terminal as shown in the figure. IOS (Instruction Operating Station) is in the centre and has own entrance. In other two compartments can be installed two control panels, while 3 main types of simulator panels are available and any of these simulators can operate independently from one another:

- Air Dive Control
- Closed Bell Dive Control
- Saturation Control - Hyperbaric Life Support System



*Figure 3-1. External view of ADAS saturation diving simulator.*

#### Air Dive Control and Compression Chamber Simulator

This simulator can be installed in one of two available rooms and allows to simulate operations related to divers' breathing and training operations in Compression Chamber. Form of the panel is shown in the next figure.



*Figure 3-2. Air dive control panel of ADAS.*

Main functions are:

- 3 different gas sources
- possibility to simulate up to 3 divers in a bell
- analogic and digital pneumofathometers
- O<sub>2</sub> and CO<sub>2</sub> analysers
- system of heating based on cold water supply
- dynamic positioning of a ship
- simulation of a video feed
- smoke inside the control room
- communication system

Closed Bell Dive (Saturation Dive) Control Simulator is shown in next figure and it can be installed in one of two available rooms and have following main functions:

- 3 different gas sources/packs
- possibility to simulate up to 3 divers in a bell
- analogic and digital pneumofathometers
- O<sub>2</sub> and CO<sub>2</sub> analysers
- system of heating based on cold water supply
- dynamic positioning of a ship
- gas recuperation system
- simulation of a video feed
- transferring in a trunk and chambers
- communication system



*Figure 3-3. Saturation diving control panel of ADAS.*

Saturation Control (Hyperbaric Life Support) Simulator can be installed in one of two available rooms and have following main functions:

- 3 different gas sources
- possibility to simulate up to 3 divers in a bell
- analogic and digital pneumofathometers
- O<sub>2</sub> and CO<sub>2</sub> analysers
- system of heating based on cold water supply
- dynamic positioning of a ship
- gas recuperation system
- simulation of a video feed
- transferring in a trunk and chambers
- communication system

Simulators can provide realistic conditions in emergency situations, for example fire on a ship using smoke emission inside a control room as shown in the next figure.



*Figure 3-4. Utilization of smoke during LSS training.*

### 3.1.2. Dive Control Simulator

The Dive Control Simulator is produced by Norwegian company PaleBlue AS which is specialized in simulation and is composed of several solutions (Pale Blue).

#### VR Diver

The simulator is using augmented and virtual reality and such systems as Oculus in order to improve initial familiarization of divers with work environment, even before starting the operations. It includes underwater environment, the bell with its controls and reproduces optical effects.

#### Crew Familiarization

The system to train crew and personnel of the plant in different aspects including safety. It allows to visit the working area including ship and to simulate different emergencies.

The Dive Control Simulator is devoted to training of air diving supervisors and is completely virtual. Considering last aspect, it has only limited certification for training and cannot substitute completely training on a real plant. The solution employs several touch screens which reproduce virtually all controls available on a real panel; meanwhile in order to create a video feed from cameras several pre-registered videos are used. The simulator handles variation of various plant parameters such as pressure and temperature. In particular, trainee is enabled to conduct following activities:

- Diving supervision
- Checklist compilation
- Simulation of operations
- Communication with divers and crew

The workstation of instructor foresees following functionalities:

- Supervise trainee and his or her actions
- Act on operations
- Communicate

- Generate scenarios for training including emergencies
- Invoke alerts on trainee's panel

The system provides possibility of integration with other simulators and models, including ROV (Remotely Operated Vehicle) simulator, VR Diver etc.

### 3.1.3. Dynamic Ship Positioning Simulators

In order to guarantee proper operation of plant it is crucial to guarantee proper positioning of the plant. Indeed, water currents and wind could move the ship or barge, causing damage or loss of the bell which could lead to death of divers. Considering this, one of important parts of work of a LSS is related to monitoring of positioning of the vessel. For example, NAUTIS simulator is certified for such training and is used as part of bigger software pack; indeed, among others, complete set of applications includes positioning and navigation simulator Electronic Chart Display & Information System (ECDIS) as well as tug operation model. The solution can be utilized with different visualization and interaction solutions, such as desktops and multi-screen systems. The instructor is enabled to move vessels and to modify external parameters.

## 3.2. Simulators for Personnel working in Modified Atmosphere

Apart from training of LSSs, it is important to take into consideration preparation of personnel for work inside facilities with modified atmosphere. Indeed, it is useful to give insight in operations and difficulties encountered by various stakeholders, hence, it allows to develop more suitable and relevant solution for training of the supervisors. Indeed, the problems to be addressed by simulators is not limited only to underwater operations, dealing with high pressure, but even operation in scenarios where pressure could be pretty low or zero such as in space and aerospace operations.

### 3.2.1. Simulators based on real hyperbaric chambers

As was mentioned, most of training operations are performed on real plants rather than on simulators. Indeed, almost all simulators which are used in training courses for LSS utilize control panels connected to a real plant. Typical training program include several parts: structure of the chamber, health & safety, operation during normal and emergency situations, side effects for humans, typical procedures and documentation, auxiliary instruments, etc. Some of these simulators are also used for diver's training. HYDRA and MEDUSA are simulators for divers' training which have been developed by HAUX. Simulators contain the atmospheric control system, power supplies (main and back-up), communication system etc. Maximum pressure is 16 bar which is equivalent to 160 meters depth. These simulators are used by German and Swedish Navy. HYDRA is certified by Germanischer Lloyd and shown in next figures, MEDUSA is shown in next figure. Both simulators contain 2 chambers:

- "Diving Chamber" filled with water
- "Living Chamber" – dry



*Figure 3-5. HAUX simulator for saturation diving training.*



*Figure 3-6. Medusa simulator for saturation diving training.*

### 3.2.2. Aerospace Industry and Environmental Simulation

Many techniques came from the aerospace industry. ECLSS (Environmental Control and Life Support System) is a set of equipment which allows to survive in a space. It supplies air, water and food, maintain required temperature for a body, acceptable pressure, manage black water.

V-HAB (Virtual Habitat) is a virtual simulator of LSS which was created for researches related to space missions, such as ECLSS of an international space station. The simulator is based on MatLab and 100% virtual. V-HAB contains all necessary for simulation of LSS's operation modules, simulating dynamically all interactions with a crew (Zhukov, Czupalla & Stuffer, 2010; Czupalla, Horneck & Blome, 2005; Czupalla, 2011).

ECLSS also is the name of a toolkit which supplies a set of components required for simulation of ambient conditions and effects of LSS during missions in space. It supports fluid dynamics, chemical and electrochemical reactions, heat exchange. It's a standard instrument of ESA, NASA and another agency are using it to evaluate modules of the international space station.

Most dangerous situation for an aircraft is a fast decreasing of a partial pressure of oxygen. This situation can cause death or loss of consciousness and is known as hypoxia. Providing a training of pilots in conditions of fast decompression while the temperature is extremely high or low helps them to improve their awareness about possible symptoms and to understand their physiological responses. An example of this type of chambers is the Falcon Altitude Chamber (UK) is shown in the next figure.



*Figure 3-7. Hypobaric chamber for pilot training*



### 3.3. Virtual and Augmented Reality for Plant Operators

Modern technologies allow to address training of high-qualified personnel in completely different ways over plants of different types. Indeed, new generation of immersive, affordable and relatively reliable technological solutions introduced possibility to employ virtual reality (VR) and augmented reality (AR) systems in the field of training of operators.

#### 3.3.1. Virtual Reality

Virtual Reality (VR) is a set of technologies utilized to create immersive and interactive simulated environments; hence, the user is isolated from the real world. Such systems are used in numerous fields, starting from education and entertainment and up to training of high qualified personnel such as surgeons and pilots. However, these solutions proven to be quite effective in support of training of various on-site personnel, starting from such goals as familiarization of newbies and up to extensive training of senior staff to operate on new equipment (Bruzzone et al., 2018a; 2017c).

The set of typically used equipment includes but not limited to Head Mounted Displays (HMD), projected environments, controllers, motion platforms, motion tracking systems, omnidirectional treadmills, haptic gloves and suits. Furthermore, often there are used combinations of physical mock-ups of systems with virtually projected environments, such as CAVEs (Cave Automatic Virtual Environment). Following images shows mockup of a port crane operator workstation installed on a motion platform, while view from the cabin is provided by projectors.



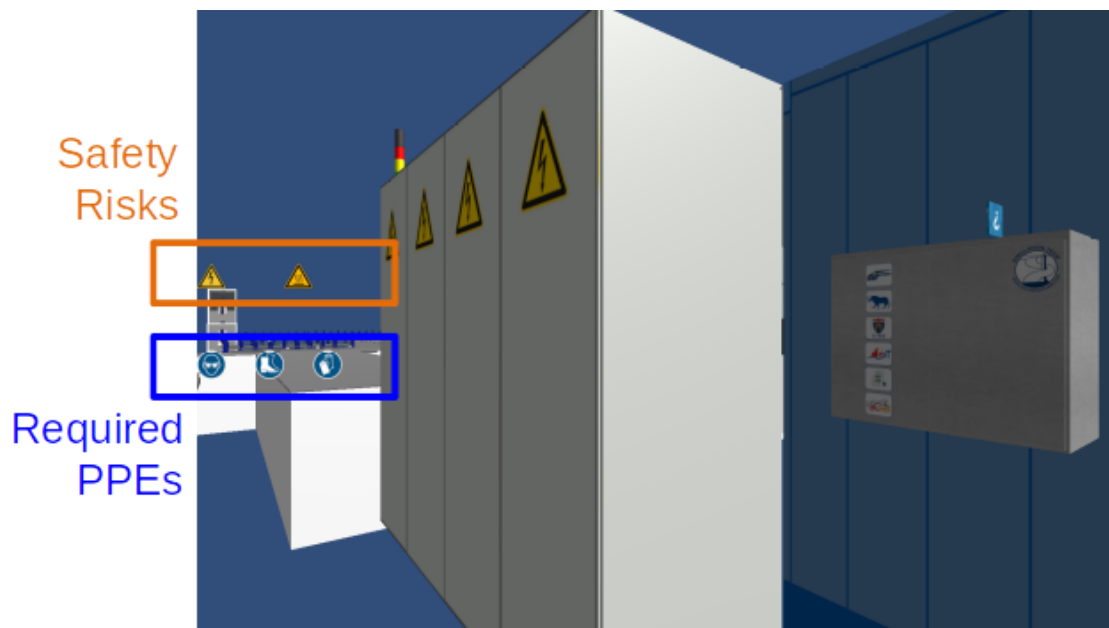
*Figure 3-8 Port crane operator workstation mock-up on motion platform*

Obviously, VR has some limitations which can be overcome only partially and only by means of additional, often significant, investments. First and most evident problems are impossibility to grab object and hold it, feel force feedback, properties of material, its temperature etc. Partially these issues are addressed by utilization of haptic gloves and suits. In other cases, the user could interact with physical equipment, such as mockup of a control panel, which makes operation very immersive and much more realistic. Another important limitation is impossibility to freely move to explore big virtual environments. Indeed, if in cases of small control room this is not a problem, simulation of entire production line or facility requires from person ability to walk more or less freely; this issues are often addressed by using combination of HMD and omnidirectional treadmill, however, cost of system in this case is much higher.

There are 2 main approaches to positioning of HMD and tracking of movements:

- Inside-out – headset and controllers are equipped with cameras which locate external fixed base station. This approach is used in HTC Vive and called Lighthouse.
- Outside-in – headset and controllers are equipped with light emitting diodes which are positioned in specially shaped constellations, so the external cameras can understand spatial state of HMD and controllers. This approach is used by Oculus Rift.

Following figure demonstrates virtual environment in which trainee has possibility to move around a production line, supervise production process and learn to troubleshoots some of principal issues which occur in this part of the plant. Furthermore, it is possible to show useful notifications such as list of risks and required personal protective equipment (PPE) in order to facilitate familiarization.



*Figure 3-9 View from VR environment, it includes indications of safety risks and required protective equipment*

In some cases, it is possible to employ also simplest smartphone based solutions. In this case, an available device is used in combination with special holder which resembles traditional HMD; hence, the application generates separate images for both eyes.



*Figure 3-10 3D model of seaport, view on Android smartphone (version for headset)*



*Figure 3-11 3D model of seaport, desktop computer view*

Utilization of completely virtual solution for training of LSSs has however several limitations. Principal consideration is that current regulations require a physical mock-up of the control room in order to obtain maximum level of certification; indeed, familiarization with physical feedback from control mechanisms is very important in this field. However, VR can be used to generate videos, which are normally used to supervise personnel inside the

plant. Considering this, VR is used in the simulator in order to provide feedback similar to that one of video cameras. Meanwhile completely virtual solution would be limited to the scope of basic familiarization.

### 3.3.2. Augmented Reality

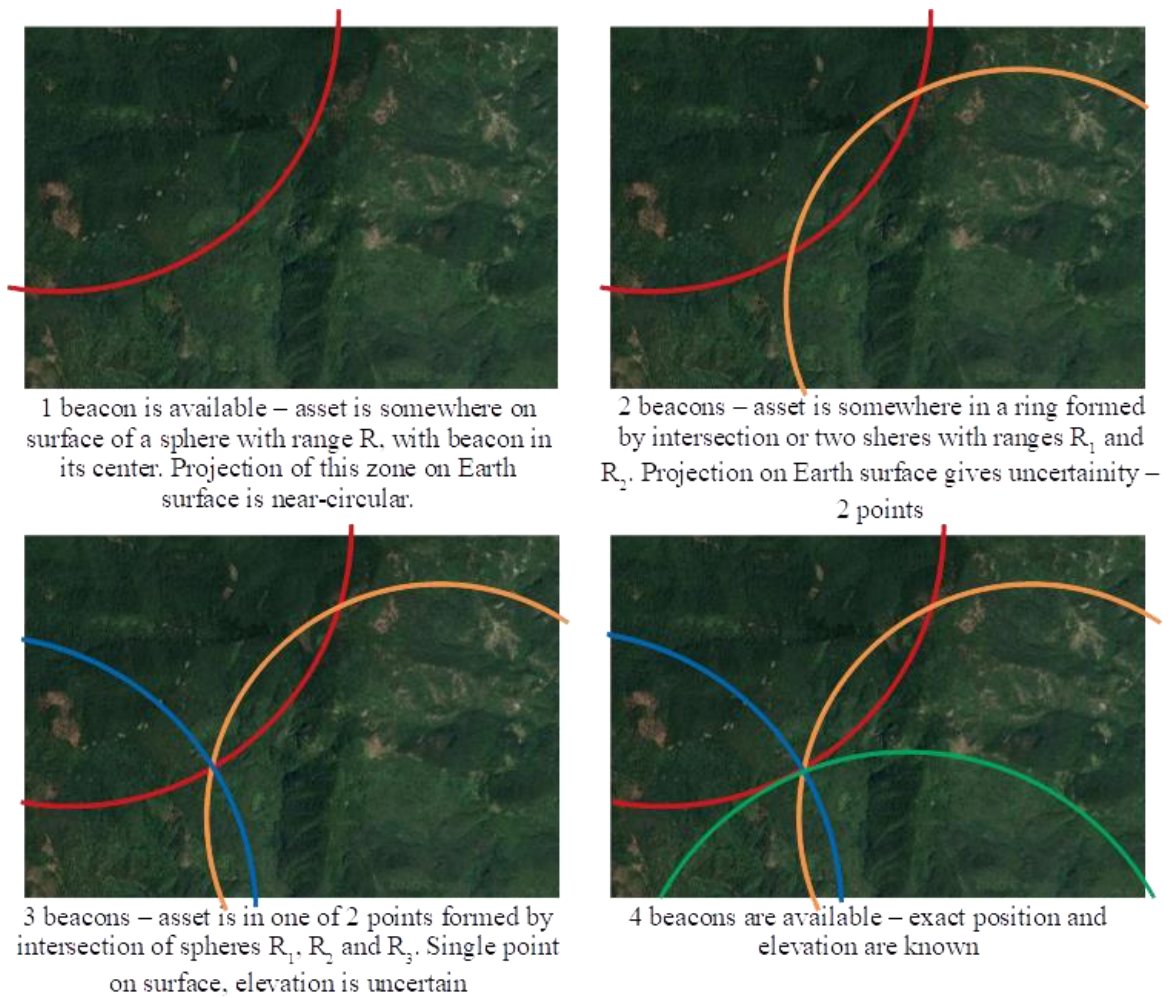
Augmented Reality (AR) overlays virtual and real world. For example, it could introduce text, images and animations on top of physical objects. Mixed Reality (MR) term is used to describe more interactive AR. (Bruzzone et al., 2019d; 2019e).

Augmented reality allows to overlap virtual and physical worlds, providing interactive access to required information, for example, visualizing instructions and manuals overlapped with real machinery, facilitating installation, configuration and maintenance, extending capabilities of remote supervision. The set of equipment includes but not limited to smart-glasses and smartphones, but it is important to distinguish between all-included systems such as Hololens and simpler smart glasses which rely on external equipment to function, e.g. on smartphone in case of Google Glass. Often, these solutions are quite expensive and too fragile for industrial environments, however, trends are showing growing number of more protected and reliable AR solutions.

One of essential factors in development of AR-based system is synchronization between physical world and augmented assets. Indeed, auxiliary information would not have much sense in case if it is displayed in wrong location or not visible at all. Considering this, it is important to identify principal approaches which are used for positioning and navigation in AR:

- Image recognition – special images (tags) are placed in known locations in the way that the headset is capable to understand its exact spatial state in the physical world
- Spatial mapping – some headsets, such as Microsoft Hololens, are equipped with 3D cameras which allow to create an approximate 3D model of surrounding environment. Once this procedure is done, it is possible to guarantee that virtual assets are maintaining properly their location respect to the physical world. This approach is very similar to that one used by human beings to orientate
- Inertial Measurement – Most of AR-enabled solutions are equipped with special Inertial Measurement Unit (IMU) which allows to trace rotations and accelerations in time. Hence, to keep track on spatial state of the system even after loss of image tag from sight

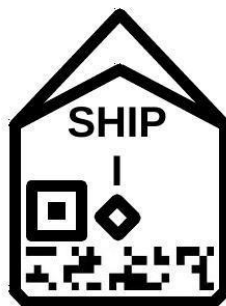
In some cases, it is useful to employ more complex positioning and navigation mechanisms, which are often not directly available with AR nor with VR headsets; in this case technology of interest is the indoor positioning based on radio beacons. Indeed, this approach allows to cover quite large areas with a system similar to the familiar GPS, while precision of positioning could be only slightly lower respect to spatial mapping. Obviously, this approach requires additional infrastructure on site as well as dedicated receivers on portable devices. In case such system is used, beacon coverage must be sufficient to avoid uncertainties in positioning, as illustrated in the following example.



*Figure 3-12 Positioning using beacons and uncertainty*

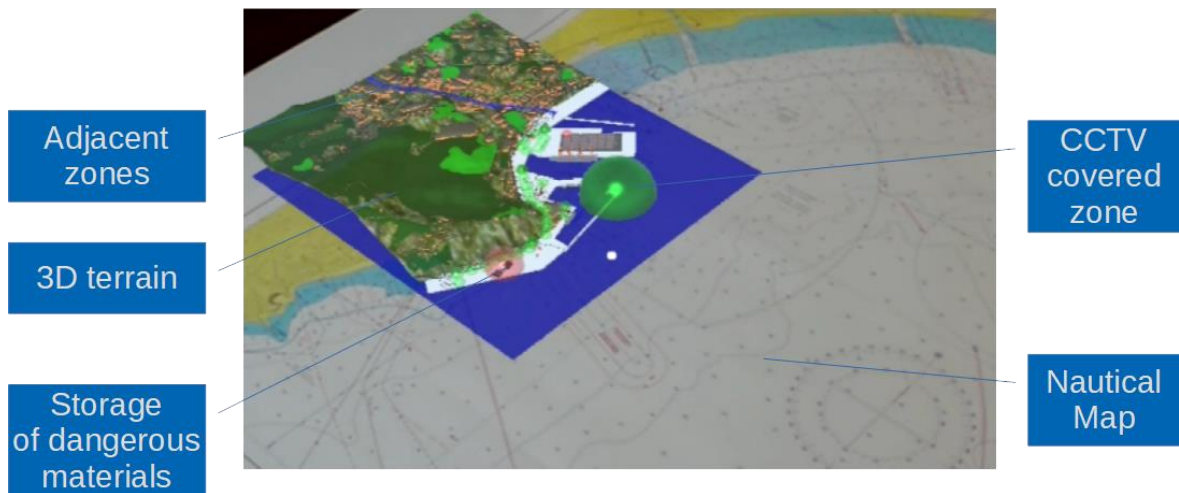
Principal mechanism of interaction with the user in case of AR are recognition of gestures and voice.

During experimentation there were created different tags to test efficiency of image recognition in operative environments. In particular, it was found that QR codes are sometime confused one with another due to very similar pattern of features (edges of graphics). Hence, more complex patterns were used, one of which is shown in the following.

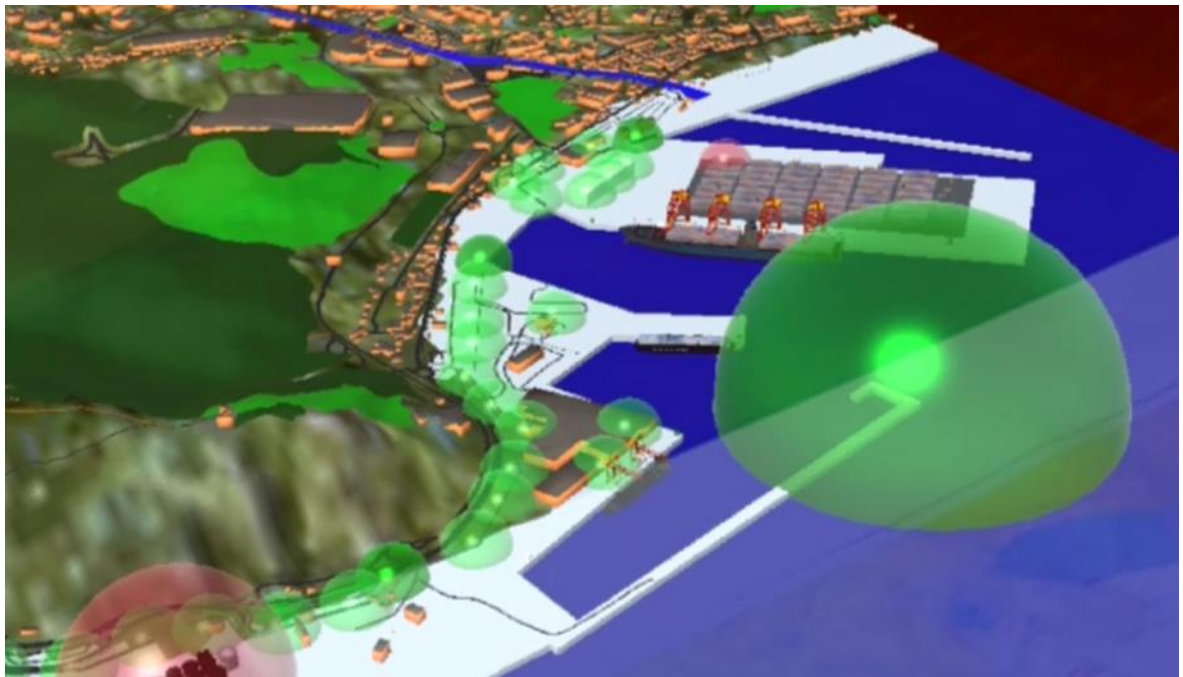


*Figure 3-13 Example of image Target for Hololens*

Following examples demonstrate utilization of AR to provide additional information to an operator or decision maker. In both cases, special markers are used to synchronize virtual and physical worlds in terms of coordinates and rotations. Hence, image recognition functionality of the AR headset is used. In the next image, it is possible to see a virtual 3D model of a seaport overlapped with a nautical map. Hence, the user is able to observe additional infrastructures, highlight storages of dangerous materials and in general have better idea about the environment of interest and its surroundings.



*Figure 3-14 View from Microsoft HoloLens*



*Figure 3-15 Zoom on a specific area*

The next figure demonstrates overlap of correct start sequence with a mock-up of a control panel. In this case, the user is enabled to use hand gestures to call for start-up instruction. This approach results quite effective in both training and support of operations.



*Figure 3-16 Capture from Microsoft Hololens: launch sequence (numbers) is overlapped with the control panel mock up*

Apart from visualization of information, it is possible to employ information about location of person to support remote supervision. For example, following images demonstrate synchronization between Hololens and virtual environment on remote machine; hence, the supervisor sees same location and angles respect to the on-site operator, which is useful for remote troubleshooting.

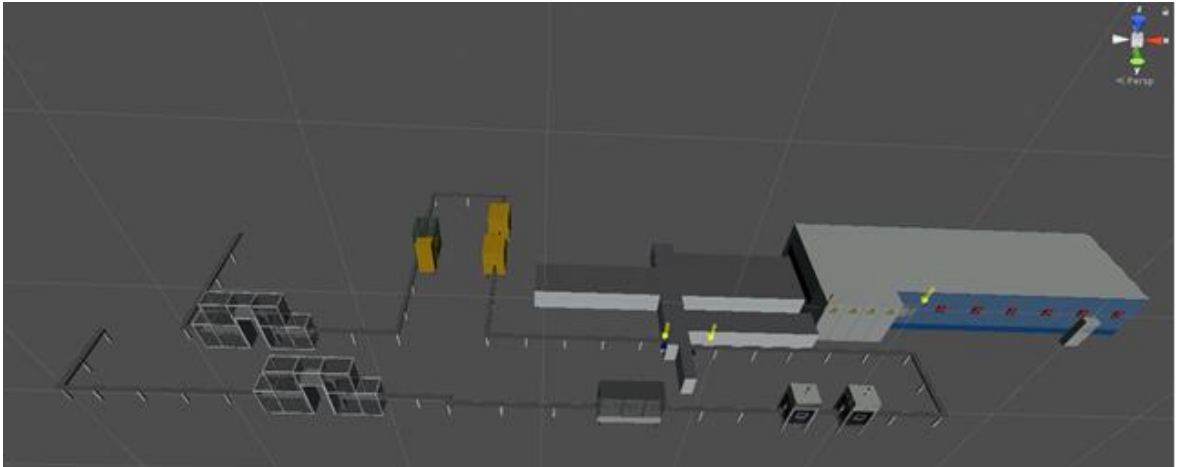
Despite some technological limitations, AR seems very efficient in training and support of personnel; in the same time, recent solutions allow to employ always more devices (e.g. smartphones thanks to ARCore) and provide more comfortable and less invasive solutions, such as retinal projection (Kress, 2019). Indeed, nowadays it is possible to see utilization of AR to support training in different fields, starting from golf and up to surgery (Ginters et al., 2019; Fida et al., 2018).

In the field of training of LSS, AR could be used to facilitate familiarization with control system by providing additional information and instructions; in the same time, operators and on-site personnel could benefit from availability of additional source of information.

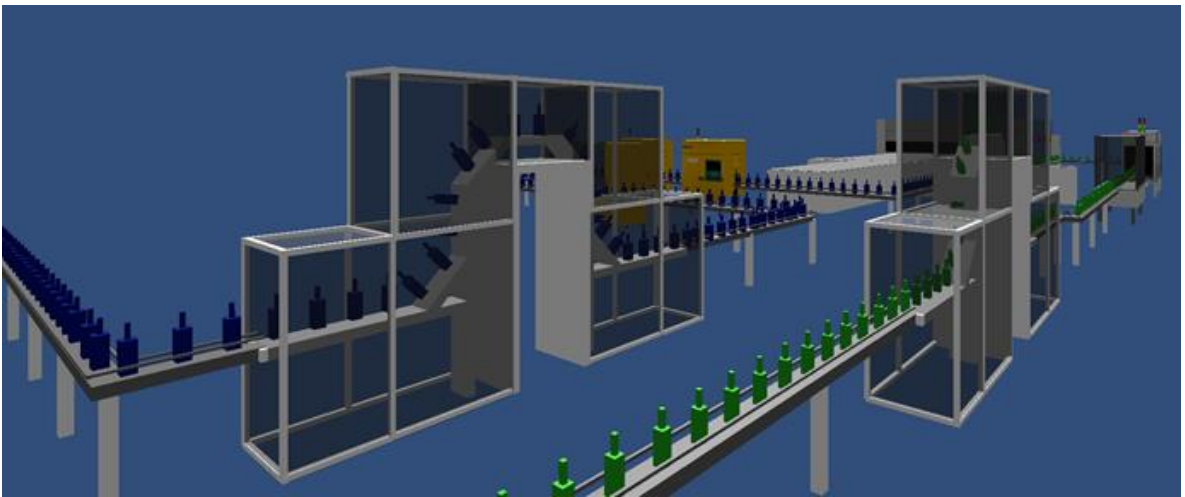


*Figure 3-17 Spatial state synchronization between HoloLens on-site and remote operator*





*Figure 3-18 Part of production line in unity 3D*



*Figure 3-19 Conveyor belts and quality control machines in simulated production line*

### **3.3.3. VR & AR Equipment Comparison**

VR & AR could be used in different fields for distinct applications and with different efficiency. Indeed, while the key idea is always the same – to immerse user in a virtual environment or to overlap physical and virtual worlds – set of technologies required to achieve goals could be pretty different. The following table demonstrates comparison of equipment used in this study, including capability of input and output as well as price, which could vary up to 3 orders of magnitude between solutions.






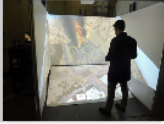
Characteristics	Google Cardboard	Samsung Gear	Oculus Quest	Oculus Rift	Microsoft Hololens v2	SPIDER CAVE
Photo						
Type	Smartphone based	Smartphone based	Stand alone	Computer based	Stand alone	Computer based
Price, approx	~10€ (without smartphone)	90€ (without smartphone)	360€	~400€	~4000€	~40000€
Weight	96g (without smartphone)	318g (without smartphone)	571g	848g	566g	~400kg
Controllers	-	1 6DoF controller with 5 buttons and joystick	2 6DoF controllers with 5 buttons, joystick and touch proximity sensors each	2 6DoF controllers with 5 buttons, joystick and touch proximity sensors each	Gesture recognition	Configurable
Positioning	Basic rotation recognition	Relative positioning using accelerometer and gyroscope	Tracking of controller position respect to the headset	Room-scale tracking of headset and controllers by external sensors	Inside-out spatial mapping	Configurable

Figure 3-20 Comparison of equipment employed in the research

### 3.4. Portable Solutions for Training and Safety

While employment of AR for training and service is quite common trend, it is often accompanied by introduction of other kinds of wearable and smart solutions. For example, same data and IT infrastructure which is used to support AR operation (dedicated wireless network, servers which elaborate and send data to clients, positioning and navigation system) could be used on common smartphones, which are much cheaper, reliable and replaceable; this consideration is especially relevant for harsh environment. Indeed, data acquisition and distribution in both cases could be very similar if not identical.

Obviously, AR and smartphone solutions are quite different in terms of interactions – the first ones are usually hands-free but data input capability from user is quite limited, while smartphones require at least one hand, but often offer more comfortable and efficient way to insert data. Considering this, it is important to note that both systems could be used in combination in order to combine benefits and cover weak parts. Representation of such architecture is presented in the following figure.

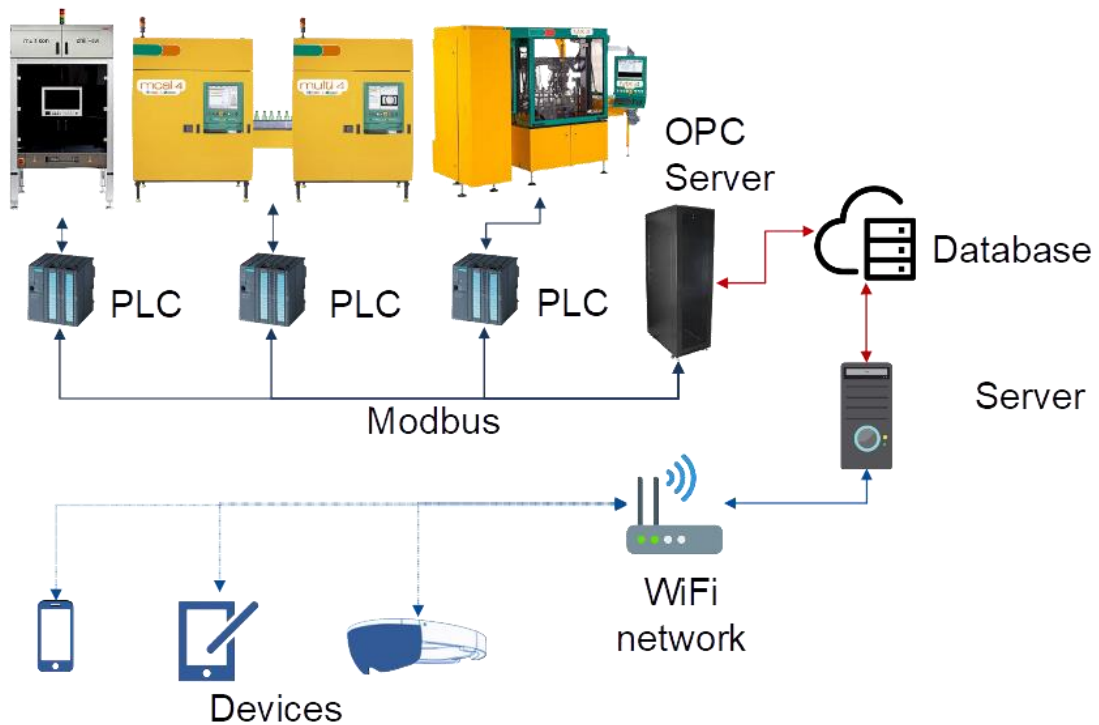


Figure 3-21 Data exchange between portable device and industrial plant server

Indeed, it was performed a study which employed combined utilization of Microsoft HoloLens and Android smartphone, which demonstrated capabilities of this architecture. In particular, AR headset was used to demonstrate alerts and notifications to the user, overlapping indicator to location of malfunction with real world; hence, the operator is able to see an arrow pointing to the source of problem as well as receive indications with its nature. Meanwhile, smartphone application is capable to display much more detailed data as well as to send feedback to the server. As shown in the following figures, it is possible to receive information about events (interventions, maintenance), see graphically trends of Key Performed Indicators (KPI), have overview of critical system parameters as well as to have rapid access to data of specific machine by means of QR-code scanner.

DATA	TIPO	MACCHINA
9/2/2018 12:41:03	Pulizia vetro	Somex
9/2/2018 12:47:05	Cambio Cartuccia	IS
9/2/2018 16:48:42	Camb. press.	IS
9/2/2018 20:51:32	Pulizia vetro	Macc-tratt-cald
9/2/2018 23:55:19	Sost. cavo dati	Tiama MX4
10/2/2018 02:04:36	Sost. Mat. Refrat.	IS

Simulation Team  
www.simulation.com

BACK

Figure 3-22 Access to last events of a machine



Figure 3-23 Visualization of machine KPIs



Figure 3-24 Visualization of production line KPIs

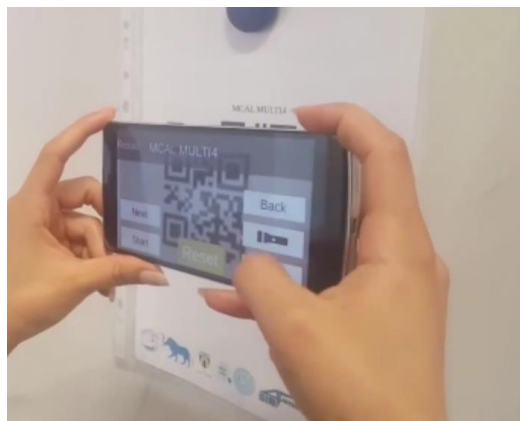


Figure 3-25 Fast access to machine info using QR-code scanner

In context of training of plant operators these systems are especially useful and adaptable. Indeed, combination of AR and mobile solution allows to perform training and familiarization of personnel on testing environments, experiment with artificially generated malfunctions and perform troubleshooting.

### 3.5. Simulation for Emergency Management and Operations

As explained previously, numerous requirements to the training procedure are caused by necessity to prepare divers to preventing, handling and mitigation of emergencies. Indeed, LSS could face different kind of problems, starting from local malfunctions and up to sink of entire ship or barge. Considering this, it is necessary to take into account existing simulation-based solutions which address these issues. In this case it is necessary to take into account different factors, but while technical malfunctions and physiological issues are covered by guidelines to the use of simulators in this field, some psychological and behavioural issues remain open.

In this sense, during the thesis it was possible to work on modelling human factors during crisis over different complex scenarios (Ozel 1992; Lee et al., 2004; Bruzzone et al., 2015); in this case the modelling approach adopted was dealing with creating stochastic discrete event agent based simulation (Yilmaz, Ören & Aghaee, 2006; Bruzzone 2013; Tong et al., 2020; Ovidi et al., 2021).

One of approaches could be to use Intelligent Agents (IA), which could represent persons and systems, replicating their logic and reaction. For instance, intelligent agents are used to manage crises in complex environments, such as entire cities; in such situation it is possible to reproduce life cycle of single individuals, groups and entire society in order to obtain exhaustive picture of a disaster consequences (Bruzzone et al., 2018b; 2020a; 2020b). In the following image it is possible to see VESTIGE (Virus Epidemics Simulation in Towns & regions for Infection Governance during Emergencies) simulator, which combines simulation of emergencies, such as virus, flood, transport infrastructure collapse, and human behaviour model in order to evaluate consequences of disasters and efficiency of preventive and remediation measures. Other simulation-based solutions could be used to forecast natural disasters (Merkuryeva et al., 2015) or to address emergencies, for instance by handling of goods and optimization of logistic network (Bruzzone et al., 2017g).

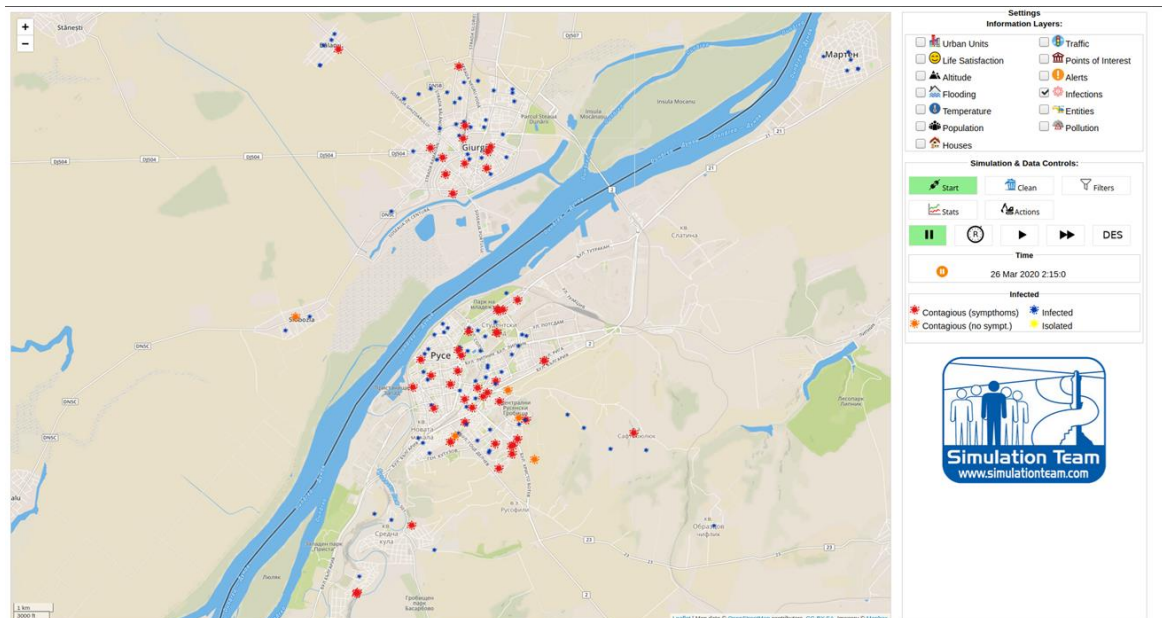


Figure 3-26 VESTIGE simulator which models diffusion of a virus in a city

In other cases, it could be possible to analyse data of past events in order to train a machine learning algorithm, which would be able to trigger certain psycho and physiological reactions reaction based on boundary conditions.

In fact the Simulation Team at Genoa University developed models of psychological factors such as fear, stress, aggressiveness and fatigue as well as models of social elements including social networks and interest groups (Bruzzone 2013).

## 4. Distributed and Interoperable Simulation

Simulation of different components of a saturation diving plant requires employment of various simulation models, such as gas model, human behaviour and physiology model, 3D model to generate video feeds similar to that one provided by cameras in real plants, various user interface systems etc. Considering this, from the beginning of the project it was clear the necessity to employ distributed simulation in it, in order to guarantee proper data exchange, event synchronization and timing of different sub-systems, not only of simulators. Indeed, in case of common frameworks of operation of simulators and other systems, proper integration is essential (Bruzzone et al., 2017d). In this chapter the most advanced standards for Interoperable Simulation are presented as well as models and developments addressed during this thesis in relation to other application fields. These models and the related experimentation allowed to develop expertise for being applied also to Industrial Plants and Hyperbaric facilities in future.

### 4.1. High-Level Architecture

Necessity to promote and standardize interoperability was clear decades ago. Indeed, in 1989 a group of interested experts organized a conference named “Interactive Networked Simulation for Training”, which led to creation of Simulation Interoperability Standards Organization (SISO); the organization since then actively working on development of standards, guidelines and promotion of interoperable simulation.

Furthermore, importance of simulation was clear for a long time also to the Department of Defense (DoD) of USA. Indeed, starting from a new policy introduced in 1996 which requires virtual prototype of all acquired weapon systems to be supplied (McQuay, 1997), while at the next logical step the interoperability between such systems was requested, and in this regard standardization became crucial. This consideration becomes evident considering that equipment and weapons could be acquired from distinct suppliers and manufacturers, could have completely different nature and have distinct destinations. In fact, the goal of interoperability was to allow synchronous execution and data exchange between such systems without introduction of major modifications in already developed systems. The necessity to standardize and regulate distributed simulation is evident considering nature of the system. Indeed, it represents System of Systems (SoS) in which every participant is developed and managed by distinct stakeholders, hence, governance of such projects could be quite complex and require specific skills and knowledge as well as ability to coordinate engineering of SoS (Bruzzone et al., 2017e).

Historically, to address interoperation issue, in 1993 first version of DIS (Distributed Interactive Simulation) standard was released (ANSI 1993), while in 1996 more advanced HLA standard was presented (Möller & Olsson, 2004).

The main concepts of distributed simulation compliant to HLA are federation and federate. In particular, federation is a group of federates connected to the same network, use same type of RTI (Run-time Infrastructure) and do interactions described in the same configuration file – FOM (Federation Object Model). Hence, federates are single programs which are interoperate in federation, which could be simulators, visualization tools and federation management applications.

Execution of the common interoperable simulation in HLA is done by means of RTI, responsible for data exchange, synchronization of federates and overall federation management. Indeed, RTI is a middleware which makes integration between simulators seamless for the user and takes care of all required procedures. Currently, several commercial and

open source RTIs are available; their main limitations is that different implementations do not guarantee to be interoperable with each other. Hence, introducing inevitable overhead in case of necessity to integrate simulator with federation which uses other RTI.

One of key features of HLA is declaration of exchangeable data by means of FOM (Federation Object Models), which specifies data structures and used interactions. For example, SISO Space FOM is used in SEE project (Simulation Exploration Experience) organized by NASA and Kennedy Space Center and includes principal information required to guarantee a realistic space simulation. In particular, it includes entity name, type, status and name of parent reference frame (textual values) as well as spatial state which is composed by position, rotation and center of mass data (all double type vectors) and time (long integer) (Mueller et al., 2016; Möller et al., 2017). This approach allowed to conduct numerous runs of interoperable simulation, shared among universities and institutions all around the world. Visualization of federation of one of this runs is presented in the figure below.



Figure 4-1. SEE 2020 federation in Pitch WebView.

As shown, the federation includes various simulators, responsible for modelling of distinct tasks, which in some cases interact one with another. For example, SpaceReferenceFramePublisher is responsible for correct hierarchy of different reference frames, which allows to participant utilization of most suitable one. Indeed, object's spatial state could be expressed in relation to Earth, Moon, Sun, centre of the lunar base etc. While it is possible to check raw exchanged data, in this project a dedicated 3D visualization solution is used and it is denominated as DON (Distributed Observer Network) in the figure. In particular, DON federate functions as a proxy in order to connect 3D environment, which does not support direct integration, to HLA federation. In the following a capture from DON is presented.





Figure 4-2. DON view during SEE 2020 testing.

In the figure, there are shown two separate entities (asteroid and interceptor), demonstrating successful interception of an astronomical object threatening to the other entities.

As anticipated, federates are necessarily simulators; indeed, based on requirements different types of applications could be included in the federation. For example, it could be a command & control tactical map, introduced to facilitate governance of the scenario, as presented in the figure below. In this case MMALT (Moon and Mars Assets Location Tool) was used in SEE project in order to provide an example of support system for a lunar base management. Indeed, MMALT demonstrates position and other attributes of entities, such as rotational state, name, status, affiliation etc.

Initially in the project HLA was chosen as basis to provide interoperability. However, due to constraints imposed by various subsystems and even their hardware it was decided to use non HLA based solution which is still capable to provide similar functionality and even to introduce other required functions.

Indeed, commonly used RTIs normally support only C++ and Java programming languages, have lack of support of modern operation systems, apart from Windows family ones, and have only fixed number of possibilities to control the distribution system (time advance, interaction and object attributes sharing), while different RTI implementations are not interoperable between each other (Granowetter, 2003).

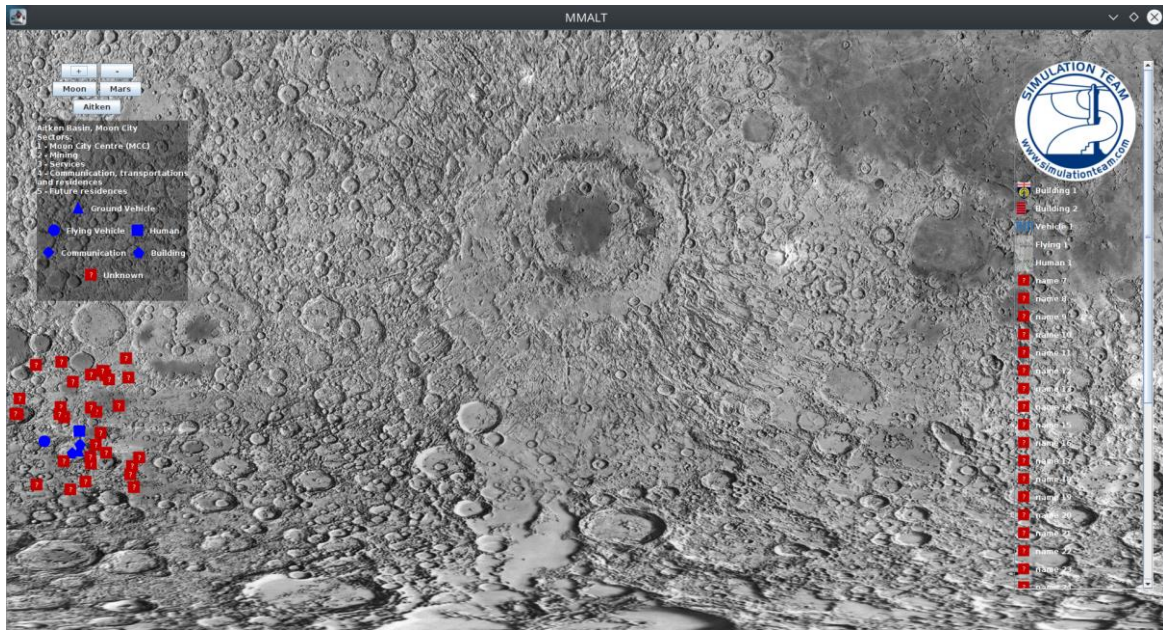


Figure 4-3. MMALT HLA federated simulator.

## 4.2. RPC-based Systems

In many cases it is not necessary or even not possible to employ HLA-based interoperable simulation. In such cases it is common to observe utilization of some task-specific middleware, platforms and frameworks, otherwise, employment of ad hoc solutions. For example, in some scenarios simulators could be required to share only limited amount of data, otherwise to interact by means of specific API (application Programming Interface) with existing systems, which would require development of a proxy to allow interactions with HLA. In such cases overhead of introduction of HLA could compensate any advantage of utilization of the standard.

In this situations, it could be convenient to adopt other approaches to the data exchange. For example, interesting approach includes utilization of Remote Procedure Calls (RPC). Indeed, RPC provides much more flexibility respect to HLA and allows to methods of simulators to call directly functions of other ones (Van Steen & Tanenbaum, 2017). For example, Apache Thrift provides communication protocol and allows call of remote procedures and is used by Facebook for scalable high load cross-language communication between its systems (Rakowski, 2015). RPC allows implementation of various functionalities, such as calling of remote methods, passing of parameters and handling of returned values. One very useful example of this functionality is possibility to call also Graphical User Interface (GUI) from a remote machine; indeed, during the research project it was implemented functionality of calling of a JavaFX GUI of the gas model from the supervisor computer, adding possibilities for fine granularity control on processes. In the following image it is presented an example of RPC call with passing of a parameter and handling of a returned value; the sequence of operations is following:

- Client program calls for a function *“func”*
- Client method stub builds call message
- Message is transmitted across the network
- Server handles data transfer and unpacks message

- Server method stub calls required function “*func*”

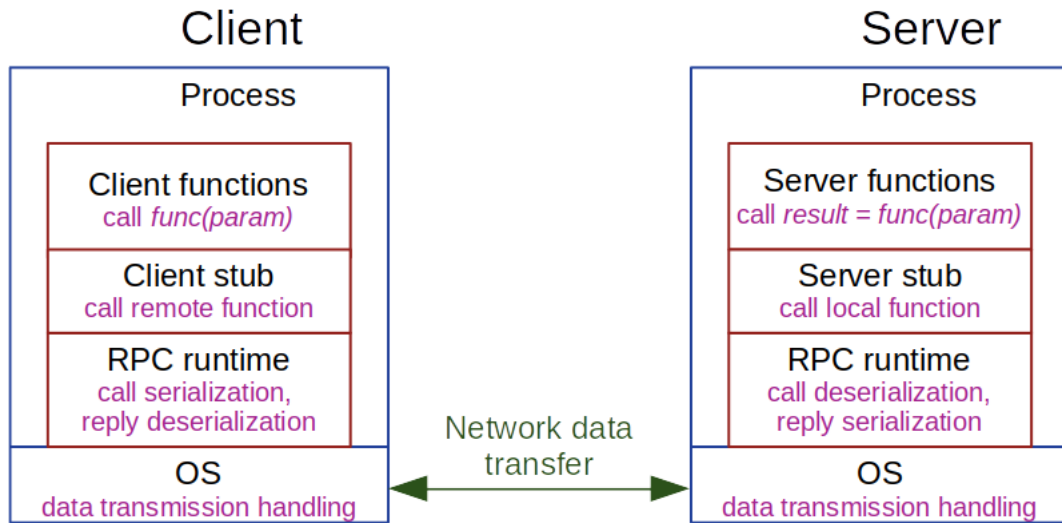


Figure 4-4. Example of remote procedure call.

Typically, in case of this kind of system, correctness of interactions is guaranteed by an IDL (Interface Definition Language), which defines all callable methods and exchangeable data structures in a single configuration file, which in this way has some analogy with HLA FOM. In the project in order to provide interoperability within highly heterogeneous distributed system this kind of solution is used. Indeed, while its functionality resembles HLA, the system satisfies compatibility requirements imposed by different hardware and software solutions and in some particular cases provides higher granularity of control.

While RPC systems and HLA’s RTI are developed for different purposes, they share common concepts, such as calls of remote procedures, declaration of data structures and their transfer (Buss & Jackson, 1998). Indeed, both approaches require and support data serialization of objects in order to be transferred, exchanged data is defined in IDL or FOM files respectively, while RTI’s time advance and data delivery mechanisms are done by means of callbacks. Hence, while in cases when utilization of HLA is formally required or when a new simulator must be integrated into consolidated federation it is convenient to employ HLA, in situations when more flexible control is required it could be convenient to use ad-hoc RPC systems.

One of architectures which can be built on top of RPC is REST (Representational state transfer), which nowadays is principal mechanism of interaction with web services (Pautasso et al., 2008; Feng et al., 2009). In this case the service would have client-server architecture and stateless communication; indeed, no open session is maintained and all requests must have all data required to handle it by the server. While in most of cases this architecture is optimal, the statelessness could introduce significant performance drop for the communication system. Indeed, necessity to perform a handshake for each request, especially if connection is encrypted, and to pass all required data cause excessive load on server compared to other approaches (Karagiannis, et al., 2015). For instance, in case of numerous and frequent updates generated by the gas and human behaviour models as well as by readers of valves values, this approach could cause some unwanted delays in execution. In such case, simulators would be required to solicit periodically the server in order to get updates.

In order to overcome this limitation, it is possible to employ a full-duplex WebSocket protocol (Fette & Melnikov, 2011). Indeed, WebSocket could be used for bidirectional data exchange, so the clients would receive updates instantly and avoiding solicitation overhead. In order to compare operation of these services it is possible to use following example. Let the client be an atmospheric composition analyser installed on the control panel mock up. In such case it would constantly need to have updates regarding the gas composition in some chambers of the plant, for instance, in main living lock. Hence, in case of RESTful service only way for analyser to obtain this data would be to constantly poll the server (e.g. every 10ms) to ask for update. Similar polling would be required even by other systems to check values of interest, e.g. to control if diver 1 is still in main lock; obviously, if diver is expecting to sleep for next hours it is inefficient to do frequent checks; however, absence of checks could lead to missed events, such as sudden start of evacuation. In contrary, WebSocket allows to establish bidirectional channel, so the server would be able to notify participants (clients) about events of interest, avoiding significant network utilization and message encoding & decoding overhead. Comparison of data exchange by RESTful service and WebSocket is presented below.

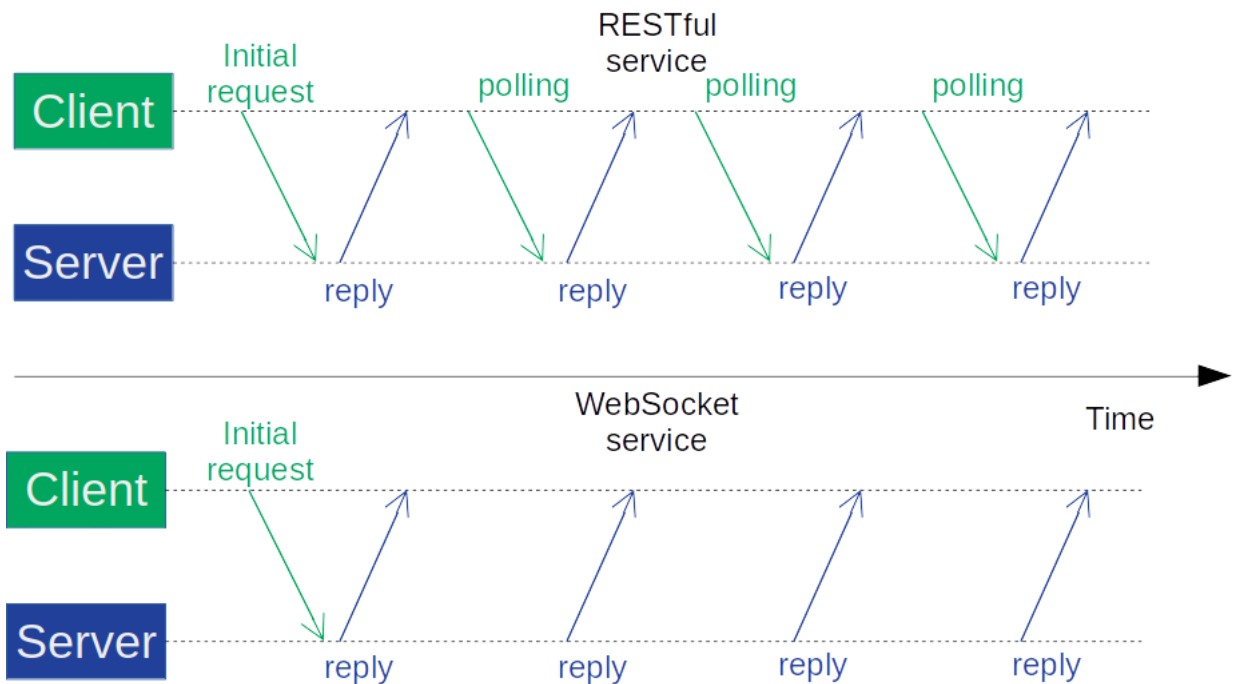


Figure 4-5. RESTful and WebSocket service comparison.

The developed system uses RPC but supports different approaches to data exchange. Indeed, it is possible to be subscribed to update and to receive them automatically, otherwise to poll server to obtain the information.

### 4.3. Distributed Ledger and Blockchain

In some situations, rather than run simulators contemporary, it is sufficient to have a common knowledge base, generated by various models. For example, traffic simulator could interact with meteorological model of a region; in this case, the first program would benefit from data about future weather conditions from the second one, in order to forecast better traffic intensity and jams. Obviously, these models are not required to run in synchronous way, especially considering the fact that data exchange would be only in one direction. Indeed, while results produced by traffic model could be heavily influenced by precipitations (e.g. rain, snow), the traffic does not have any significant impact on environmental conditions. In this case, the interoperability could be asynchronous and be limited to utilization of a shared reliable data storage. While in many cases it could be sufficient to have a common database, sometime additional data certification functionality could be required.

Distributed Ledger Technology is a way to provide a distributed, decentralized shared and synchronized for data storage (Harrison, 2015).

Distributed Ledger Technology is a distributed database that maintains a continuously growing list of data records secured from modifications. The most known utilization of DLT is Bitcoin, a cryptocurrency system which uses Blockchain to guarantee data integrity (Nakamoto, 2008) In this case, DLT is a core component of Blockchain, which is responsible for storage of data. Indeed, the idea of Blockchain was born originally as part of Bitcoin cryptocurrency, but after has outgrown it and currently has much larger field of potential applications. The name Blockchain reflects exactly the nature of this distributed data storage system. In fact, a Blockchain consists of blocks, which in case of cryptocurrencies contain batches of single transactions. While initial goal was to store log of financial operations, it is possible to save in blocks any kind of information, such as documents and their digital signatures. Indeed, availability of secured data storage allows, for instance, to publish documents on various less protected platforms, while maintaining their checksum or digital signatures in Blockchain for integrity checks; hence, it would be always possible to certify provenance of downloaded data.

For example, among projects which use DLT or Blockchain for non-cryptocurrency purposes there are programs dedicated to tracing of provenance of products and spare parts, guaranteeing chain of trust between participants of a distributed supply chain. Meanwhile, it is important to note, that often Blockchain and DLT functionality is misunderstood and the technologies are used improperly, which often lead to failure of projects (Disparte, 2019). One of typical problems of Blockchain is so-called “51% attack”. Indeed, many Blockchain applications have open access to anyone, while writing on Blockchain is regulated by means of consensus algorithm in which participants vote to trust or no to a new data entry. Obviously, in case of small networks malicious participants could approve saving of anything in Blockchain.

In order to understand safety mechanisms of Blockchain it is possible to use the figure below, which demonstrates how each block includes some new data (e.g. list of new transactions or potentially any kind of data) and meta information. In this case, this metadata is critical in order to guarantee data integrity; indeed, that is exactly the header of an any new block that confirms integrity of the previous one and of its stored data. In particular, header includes information regarding timestamp (date & time) of creation of this particular block, hash of previous block and hash of a Merkle tree root, which is required to verify integrity of single transactions or data entries.

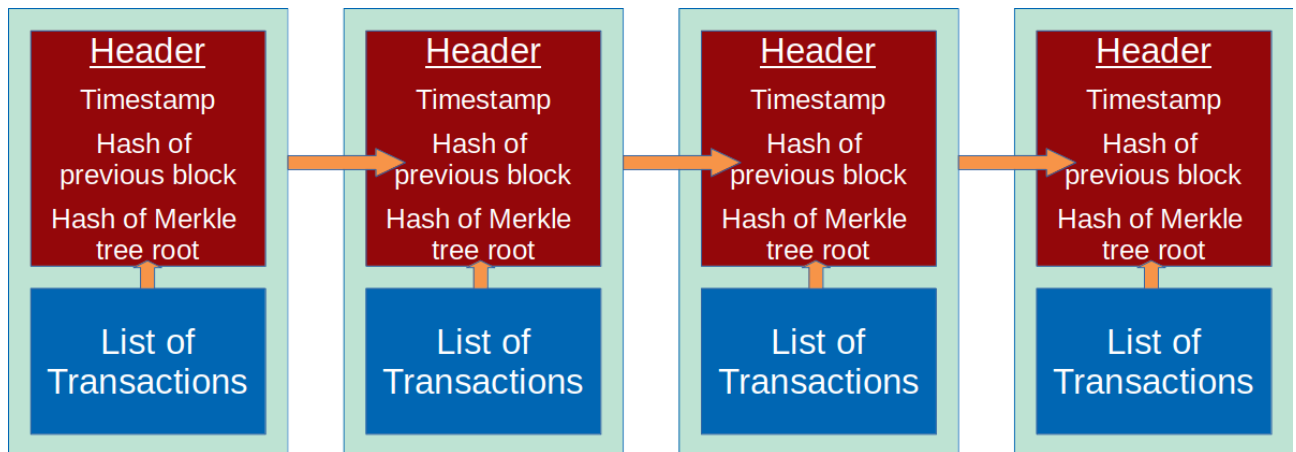


Figure 4-6. Chaining of block in Blockchain.

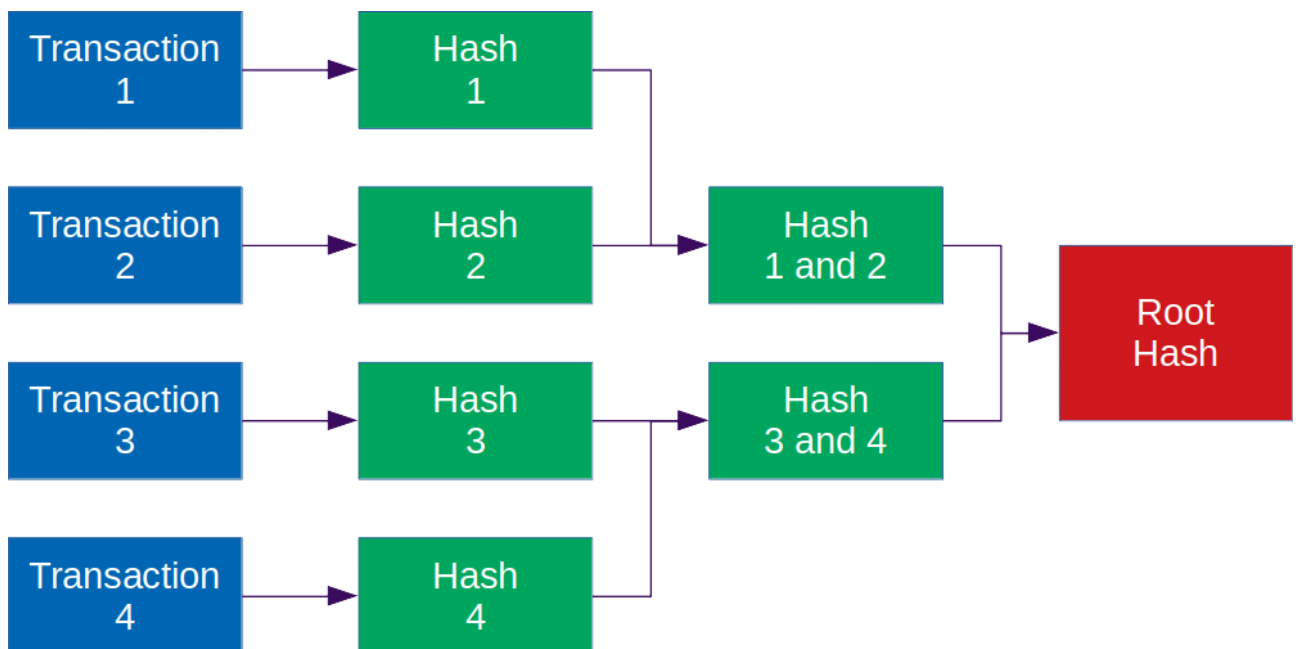


Figure 4-7. Merkle Tree.

Hashing is one of principal operations required for Blockchain operation. The operation of hashing is quite simple and provides mapping of arbitrary input values into numbers (Ferguson, Schneier & Kohno, 2010). The resulting number is strictly deterministic but due to nature of algorithm it behaves stochastically to an observer; this consideration allows utilization of hash in numerous applications, especially that ones related to data verification and integrity check.

As mentioned, DLT could be used to certify input and output data of single simulators, allowing tracing of provenance of information. In particular, it is possible to store in blocks of Blockchain information regarding source of input data (e.g. simulator name), its timestamp (date and time of upload) and some metadata (e.g. scenario identification number, key parameters). Furthermore, additional functionality provided by modern frameworks such as Hyperledger Fabric (Androulaki et al., 2018; Sousa, Bessani & Vukolic, 2018) allows to

operate various types of data and provide fine granularity of access control and data protection. These considerations allowed in last years to employ DLT and Blockchain in various fields, starting from certification of documents by public administration and up to exchange of physical assets using special tokens. For this reason, it is necessary to study possible utilization of Blockchain and DLT in the field of interoperable simulation.

Possibility to provide additional layer of data certification by means of DLT could be confirmed by the following example, which addresses town development and industrial plant engineering (Bruzzone, Massei & Sinelshchikov, 2019). The presented scenario is used to demonstrate data exchange between simulators which deal with traffic, human behaviour, natural disasters, economic development and crime dynamics (Bruzzone et al., 2014; Bruzzone et al. 2017a). In this case a previously mentioned Hyperledger Fabric framework is used. While in this demonstration only data storage functionality is used, the framework allows future extension to introduce such Blockchain-specific applications as smart contracts. Another advantage of chosen solution is possibility to write smart contracts in general purpose programming languages instead of synthetic limited ones, typical for other Blockchain implementations; furthermore, the contracts could be even encrypted. Indeed, all this functions allow using HLF in various different fields, for example in food safety, contract management, diamond provenance, rewards point management and identity management as well as to target other business applications. Interesting property of HLF is separation of nodes responsible for smart contracts execution (named peers) and that ones responsible for consensus on order of operations. Hence, before writing on Blockchain, clients submit required data to peers in order to obtain signed results of the execution. After this, clients submit signed update to the ordering service, which distributes a sequence of updated blocks among the peers, which perform validation.

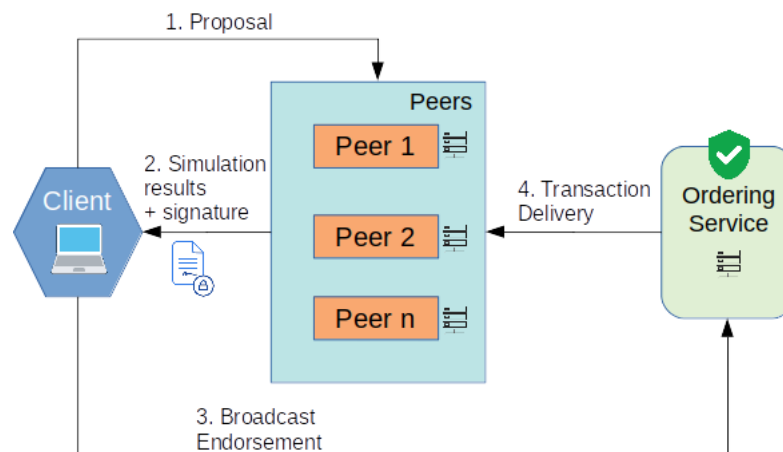


Figure 4-8. Hyperledger Fabric transaction approval procedure.

The testing scenario used for demonstration is named “RS” and employs 3 simulators, responsible for different aspects of urban development. In particular, urbanized area of interest is situated near state border, includes mountains and river, hence, threats to inhabitants could have different nature, from natural to artificial one. In this scenario, player has possibility to investigate impact of its investments on city development, by activating industrial plants, power plants, developing tourism etc. Indeed, user must take into account numerous factors and consequences of his actions, for example, of budget planning, human development, population growth, criminal situation and environmental sustainability of the city.

In this demonstration 3 simulators are used to reproduce specific aspects of this urbanized area, while interoperating by means of Blockchain. In particular, the simulators demonstrated mutual influence caused by reading and writing of information on distributed ledger; in the same time, it was confirmed possibility to block unauthorized access and to identify and avoid tampered data entries. In order to overcome performance limitations of Blockchain, a dedicated MySQL database (DB) was used to store simulation results, while Blockchain is used to store its checksum and metadata as shown in the following figure. Hence, every time a simulator reads data from DB, it calculates checksum and compares it with that one stored in Blockchain. The data is stored in database in JSON (JavaScript Object Notation) format.

Obviously, interaction between sub-systems of the simulator must be in real-time, which requires different types of middleware in order to provide communication. However, such information as meteorological conditions, sea currents and status of surrounding infrastructures could be obtained from external sources. In this case utilization of Blockchain should be taken into account as one of possible mechanisms for the certified data exchange.

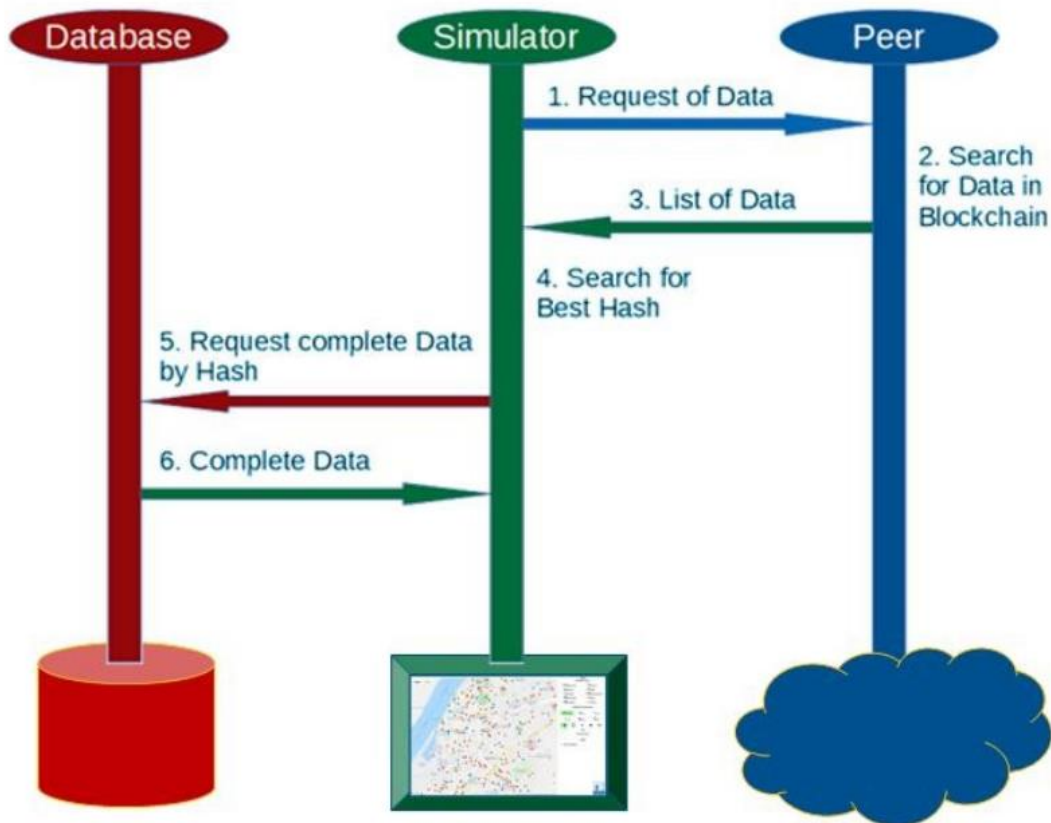


Figure 4-9. Combination of DLT and DB usage for testing scenario

In the case study, introduction of Blockchain or DLT-based solution could be used also to certify training, for instance, by storing in tamper-proof way key information about simulation parameters, date and time, trainee data, events etc. Indeed, storage of all exchanged information could be quite computationally heavy, however, partial logging could be good compromise in this case. In particular, it is possible to connect the Blockchain to the data exchange system in order to periodically acquire most critical information, sign it with a



cryptographic key (e.g. RSA) and store data or its hash in safe way. Example of such data block is presented below.

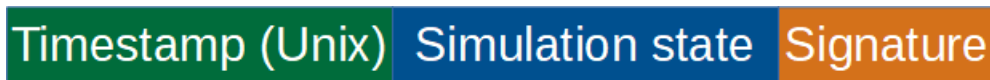


Figure 4-10 Dataframe saved in blockchain

#### 4.4. Proxies and Gateways for Distributed Systems

Possibility to integrate different simulators, applications and even hardware components to a distributed system is essential for deployment of the system of interest. Indeed, in order to develop an environment with mock-up of physical control panel, simulator of gas dynamics, human behaviour model and simulated video, it is critical to guarantee proper communication between all its component. However, in practice all data exchange infrastructures used to establish communication between single nodes have limitations and often it is required to introduce additional modules to be able to connect some or even all components into unique system. Furthermore, in some cases even standardized solutions do not foresee proper interoperability between implementations created by different vendors. For instance, well established and consolidated HLA standard miss possibility to connect solutions developed to run with different RTIs; this problem is already addressed by developers, however, solution of this problem is still not available (Moller, Antelius & Karlsson, 2018). In other cases, the solution used to create distributed system could have no support of programming language of a specific software; such difficulty occurs for instance when it is required to connect a Unity 3D environment, which uses mostly C# programming language, and commercial HLA RTIs, such as Pitch or VT MAK, which lack support of C#.

Another example which illustrates necessity of an intermediate proxy is related to connectivity to specific hardware solutions. For instance, in case an equipment is controlled by a microcontroller or simple System-on-Crystal solution, it could be impossible to guarantee proper data exchange in terms of connectivity, security or encoding and decoding. In such cases a proxy, which could be a HLA federate or Object Request Broker of CORBA, is required to connect a simulator, model or physical equipment to the distributed system, as illustrated in the figure below.

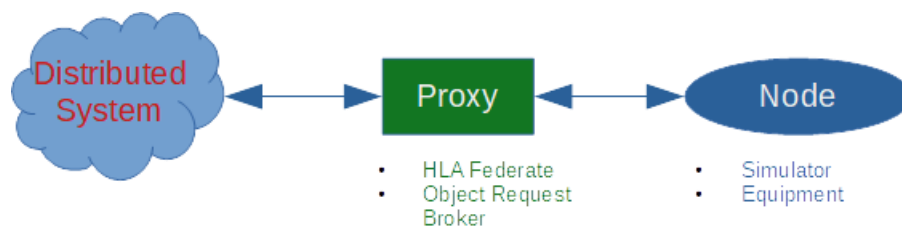


Figure 4-11. Connection of a node to a distributed system through a proxy

#### 4.5. Other Distributed Simulation Systems

Sometime distributed simulation is used simply to share available unused computational power in order to ‘donate’ it to some task which owner of computer considers worthy. For example, such middleware as BOINC allows to perform distributed computing and to contribute in various important projects, such as analysis of data from Large Hadron Collider (Karneyeu et al., 2012) or in various medical research (Hand, 2010). Another interesting example of similar nature is Folding@Home, which became popular during COVID-19 pandemic (Zimmerman et al., 2020); in particular, the system is used to simulate and evaluate impact on different drugs on the virus. The project became so popular that it was the first system in history to surpass 1 exaFLOPS (FLoating point Operations Per Second) of computational power, and in the middle of April 2020 it even surpassed capacity of all TOP500 world super computers combined (Broekhuijsen, 2020). Interesting aspect of the last system is that contrary to high-performance supercomputers, it is composed mostly by home or office personal computer and notebooks. Indeed, this consideration shows possibility to construct complex data processing systems using relatively simple, general purpose components.

## 5. System Requirements

One of the benefits of using simulators according to IMCA is reduction of LSS training course duration. Indeed, this is caused by the fact that in case of practice on the real plant in the usual way, only normal operation can be studied, while using a simulator the number of events and emergency situations can be significantly increased. For example, instructor can invoke a fire and evacuation scenario, start gas leakage and equipment malfunction improving therefore the preparation of future LSS. For this reason, LSS which is studying on a simulator requires two times less time of practice to be able to attend to an IMCA certification.

Main document which describes requirements to simulator to be certified is IMCA Guidance on the Use of Simulators. It describes types of simulators which can be used in the marine contracting industry for training and gives a definition of a simulator as the creation of certain conditions by means of a model, to simulate conditions within the appropriate sphere of operations. But there are many applications of simulators besides training. They can be used to perform work planning, research and risk assessment. Main difference between simulator and e-learning systems is high realism level of simulator, which can mimic real world, while e-learning can teach to handle only limited set of operations and situations. Different classes are identified to distinguish levels of simulators, for example 4 levels of LSS simulators are presented.

It is important to notice that it is not required to simulate precise gas propagation between chambers or through pipes using fluid dynamics. So at the moment when a hatch is opened it is acceptable to have instant temperature and gas concentration redistribution.

From the point of view of LSS system consists of 3 principal elements: hyperbaric plant, control room and HCU. There are also 3 secondary systems which are controlled by LSS indirectly: gas storage and distribution system, back-up power supply system and control of SDC position using winches. The last one in some cases is controlled from the control room. Normally 3 winches are presented: for SDC, ballast and one for emergency situations. In any case winches control requires coordinated work of LSS and technicians outside of the chamber.

Simulator must be able to perform following main activities: compression and decompression of each single chamber of lock, provide information of O<sub>2</sub> and CO<sub>2</sub>, support actions required to clamp SDC, handle fire or pollution, blackwater exhaust, control of winches and emergency situation with SDC. Following physiological problems of divers must be simulated: gas concentration problems (oxygen toxicity, anoxia, CO<sub>2</sub> poisoning, O<sub>2</sub> poisoning, nitrogen narcosis and neurological syndrome of high blood pressure; barotrauma, hypothermia, hyperthermia, regurgitation in water. Simulated divers have to start to demonstrate symptoms of illness after the command of instructor or plant's state change.

Instructor can act on plant atmosphere in real time, for example to cause gas leakage or pollution. Both LSS and instructor can change plant's conditions, but to maintain right valves positions instructor can't have any possibility to operate with panel's valves. Otherwise, LSS can act only these valves.

As was mentioned above main scope of simulator is to provide high realism level, because it directly impacts the effectiveness of the training course. To obtain maximum efficiency of training instructor must be experienced not only in equipment usage, but also have deep knowledge of the operations being simulated and simulation usage. Another requirement is good communication skill of instructor, well-structured lesson plan to the activity, objective evaluation and feedback from the instructor.

It is very important to ensure that work in safe environment does not lead to any unsafe action which trainee could repeat after working on a real plant, creating dangerous for divers' health situations and causing equipment damage. One of the possibilities to do it is to make debrief after training.

Depending of various visual parameters, realism, fault implementation and logging simulators can be distinguished in 4 classes: A, B, C and S, where the first one is closest to the typical plant control system. Detailed set of requirements is presented in the next table.

Because developed simulator will be used for LSS training and certification it is strictly required to satisfy all class A certification criterion. It means that functionality of simulator must completely correspond to the real plant as presented in the following tables.

LSS operation can be divided in activities, for example planning, equipment checks and calibration, change of gas mixture, decompression etc. So it is required from simulator to allow LSS to perform all typical and emergency activities.

IMCA developed a set of scenarios for use in training of LSS and other personnel on control panels. Each descriptions of scenario contain an overview and possible deviations to provide a basis for the development of more detailed training procedure by a company or training establishment according to IMCA offshore diving supervisor and life support technician schemes.

*Table 5-1. Simulator requirements*

Simulator Class	Operator Interface	Visuals	Environmental Realism
A Utilizes an accurate physical representation of the control room equipment, realistic physics, suitable visual feeds.	Real World	Representation of viewports/port-holes Lighting controls Camera controls	State of the sea External factors Conventional communications systems External systems (e.g. bell clamping)
B Similar control room equipment, realistic physics, basic visuals	Comparable	Representation of viewports Lighting controls Camera controls	State of the sea Limited external factors Limited communications systems Limited external systems
C Similar control room equipment, basic physics and limited visuals	Dissimilar	Lighting controls Camera controls	State of the sea Limited external factors
S System specific hardware	System Specific		

*Table 5-2. Simulator requirements (continue)*

Simulator Class	Behavioural Realism	Fault, Error and Failure Generator	Logging	Scope of Use
A	Accurate gas and thermo dynamics Accurate subsystem and instrument behaviour	Extensive fault introduction with realistic flow on effects	Compliant IMCA D 013 – IMCA offshore diving supervisor and life support technician schemes	Advanced training
B	Basic gas and thermo dynamics Basic subsystem and instrument models	Limited fault introduction with limited flow on effects	Compliant IMCA D 013	Basic training Concept familiarization Task rehearsal Equipment familiarization
C	Basic gas dynamics Limited subsystem and instrument models	Limited fault introduction	Not logged	Concept familiarization
S			Not logged	

Considering this requirement, it is possible to create different versions of the same simulator, suitable for different purposes. For instance, it is possible to construct full scope simulator to be used for certified training in fixed or rarely change place (class A) and a limited version for familiarization in class or to demonstrate in exhibitions (class C or S).

Indeed, considering modular nature of the system, it becomes possible to employ only part of its components in order to perform same actions a LSS is expected to do in real control panel, but using completely virtual duplicate.

In the following, it is possible to observe more detailed list of requirements which IMCA imposes to simulators in order to be certified for advanced training (class A).

*Table 5-3. Required features for class A certification by IMCA*

<i>Item</i>	<i>Requirement</i>	<i>1/2</i>
1	Controls and displays are to be arranged in a similar way to an offshore control panel	
2	Dive controls and displays are emulated	
3	Bell/diver gas controls are equivalent to those used offshore	
4	Gas reclaim systems respond in an equivalent manner to those used offshore	
5	Analogue gauges operate in response to simulated actions	
6	Analogue gauges are represented by graphic representations	
7	Digital gauges operate in response to simulated actions	
8	Digital gauges are represented by graphic representations	
9	Gas analyzers display gas quality from multiple sources	
10	Gas analyzers contain adjustable alarms	

<i>Item</i>	<i>Requirement</i>	<i>2/2</i>
11	Flow meters demonstrate flow rates	
12	The supervisor can select between camera available views	
13	Divers behave as divers would	
14	Divers respond to request from dive control	
15	DDC controls are available	
16	Hot water pumps are simulated	
17	Hot water pump warnings are adjustable	
18	Dynamic position warning lights look and operate conventionally	
19	Hydrocarbon warning devices are available	
20	Smoke generation is available in the control room	
21	Visual representation of bell and clump 'line out' is available	
22	Simulated black box recording is available	
23	Communications devices are equivalent to those used offshore	
24	Multiple communication devices are routed through one device	
25	Communication devices are emulated or output to computer speaker	
26	Communication devices simulate and adjust voice anomalies resulting from pressure or gas variation	
27	The supervisor can control diver lights and cameras	
28	Accurate representation pneumofathometer identifies and displays simulated diver or bell depths	
29	Basic representation pneumofathometer identifies and displays simulated diver or bell depths	
30	Navigation data is displayed through a survey screen	
31	Navigation data is delivered as a representative view	
32	Simulated trunking can occur	
33	A separate instructor's station is provided with video surveillance	
34	Students' actions are recorded	
35	The instructor has control of all the variable outputs/readouts on the simulator	
36	Simulator physics engine responds to instructor manipulation	
37	The instructor is able to communicate with the supervisor as another entity (i.e. bridge, crane operator, etc.)	
38	The instructor is able to fault or trigger faults during a simulation	
39	The instructor is able to control diver depth	

Fulfilment of presented above requirements is essential for obtaining certification of the final system for LSS training activity. Considering that this is exactly the main goal of the research project, each step of development since the beginning was accompanied by verification of presented requirements. Apart from requirements to the system, IMCA identifies list of procedures which should be possible to perform on a simulator, with main actions and steps summarized in the following. These operations are intended to train different kind of personnel, indeed, some scenarios are intended only to diving supervisor or to LSS with LST (Life Support Technician), hence, based on scope of the simulator only some of them could be implemented.

*Table 5-4. Training scenarios*

ID	Name	Main target personnel	Goals
1	Pre-dive planning – briefing	Diving Supervisor	Check essential knowledges of trainee, control room checks
2	Set-up of air dive control/panel	Diving Supervisor	Check and calibration of panel equipment
3	Set-up of saturation diving control panel	Diving Supervisor	Check and calibration of panel equipment, bell and vessel alarm, gas analysis
4	Bell diving	Diving Supervisor	Move divers from transfer chamber to the bell and its sealing
5	Bell launch/recovery	Diving Supervisor	Bell deployment and recovery
6	Air Diving	Diving Supervisor	Deploy and recover diver
7	Pre-saturation checks	LST/LSS/Diving Supervisor	Control room and external equipment checks
8	Panel checks	LST/LSS/Diving Supervisor	Provide gas supply to the panel
9	Analyser setup and Calibration	LST/LSS/Diving Supervisor	Calibration, check of gas composition in chambers, alarms setup
10	Life support startup	LST/LSS/Diving Supervisor	Control and setup of HCU and scrubbers
11	Chamber blowdown	LST/LSS/Diving Supervisor	Gas selection, initial blowdown and leakage check, pressurization to required value
12	Maintaining storage depth	LST/LSS/Diving Supervisor	Maintenance of level of pressure, temperature and humidity
13	TUP procedures	LST/LSS/Diving Supervisor	Diver transfer between bell and transfer chamber
14	Sealing chambers and trunks	LST/LSS/Diving Supervisor	Sealing trunks, pressure equilization
15	Changing over of gas mixes	LST/LSS/Diving Supervisor	Line venting & pressurization, disconnection of one gas supply and connection of another one
16	Decompression	LST/LSS/Diving Supervisor	Complete decompression procedure

All presented scenarios include remediation of possible deviations, such as missing documentation or marking of equipment, leakages, diver sicknesses, equipment malfunction, abnormal gas concentrations, fire etc.

### 5.1. Goals and Tasks

As mentioned previously, the main goal of the project is to develop an innovative simulation solution suitable for training of Life Support Supervisors responsible for saturation diving activities. Considering this and the requirements to the system imposed by certification authority, it is possible to identify following principal subsystems which must be included in order to attain all requirements:

- Gas dynamic model
- Human behaviour model including physiological reactions
- Mock-ups of real equipment to be used as user interface for trainee
- Instructor command interface

Furthermore, all subsystems must be integrated in order to interact with each other. For example, when trainee rotates a valve on a mock-up panel, gas dynamic model has to receive corresponding signals in order to recalculate gas composition in different parts of the plants. Meanwhile, virtual divers in the plant must provide realistic feedback to actions of the operator, which could be vocal notification of ringing in the ears due to rapid pressure growth. Furthermore, it is required to provide a communication functionality in order to be able to interact with virtual divers. In this case, due to unnecessary increase of complexity due to speech recognition, voice generation and behavioural logic, it was decided to allow to a trainee to use replicas of internal phone communication system to speak directly with the instructor. Obviously, it creates some additional work for the operator.



## 6. Principal Simulation Models

The simulator is a complex system composed by a set of sub-systems, developed by different stakeholders and required to interact with each other in order to guarantee proper training experience. Indeed, the main components are gas dynamic model, human behaviour model, control panel mock-up, instructor workstation and infrastructure required to guarantee proper interaction between other sub-systems.

### 6.1. Gas Model

First task in creation of the simulator model is an analysis of gas distribution system in the existing plant. This system consists of gas cylinders, tubes with valves and different volumes such as chambers, trunks and locks. Furthermore, there are several manifolds where gases are mixed.

Another consideration is that there are different types of valves in the plant. First is a sphere valve which is used to control gas flow, second is a needle valve required to switch off some measurement equipment and the third is back-pressure regulator required to reduce pressure. Typically, pipes have a diameter less than 1 inch (2.54 cm), so their volume is negligibly small.

Considering this, physical model can be represented as a mathematical graph as shown in the following figure where tubes are represented as arcs and all other parts of a plant including surrounding atmosphere, are represented as nodes (Van Steen, 2010). This kind of representation simplifies development of system, modification of configuration and initialization; indeed, only key parameters of nodes and arcs are required to build the system while graphical representation resembles plant's P&ID which makes it easier to control.

This approach allows simplification of calculation of gas transfer, because only one step is required to find a flow between two connected nodes. In particular, gas containing cylinders are marked as  $G$ , while pressure regulators are labelled by  $P$ , while other plant components, such as manifolds, chambers and external atmosphere are labelled as  $M$ ,  $C$  and  $A$  respectively.

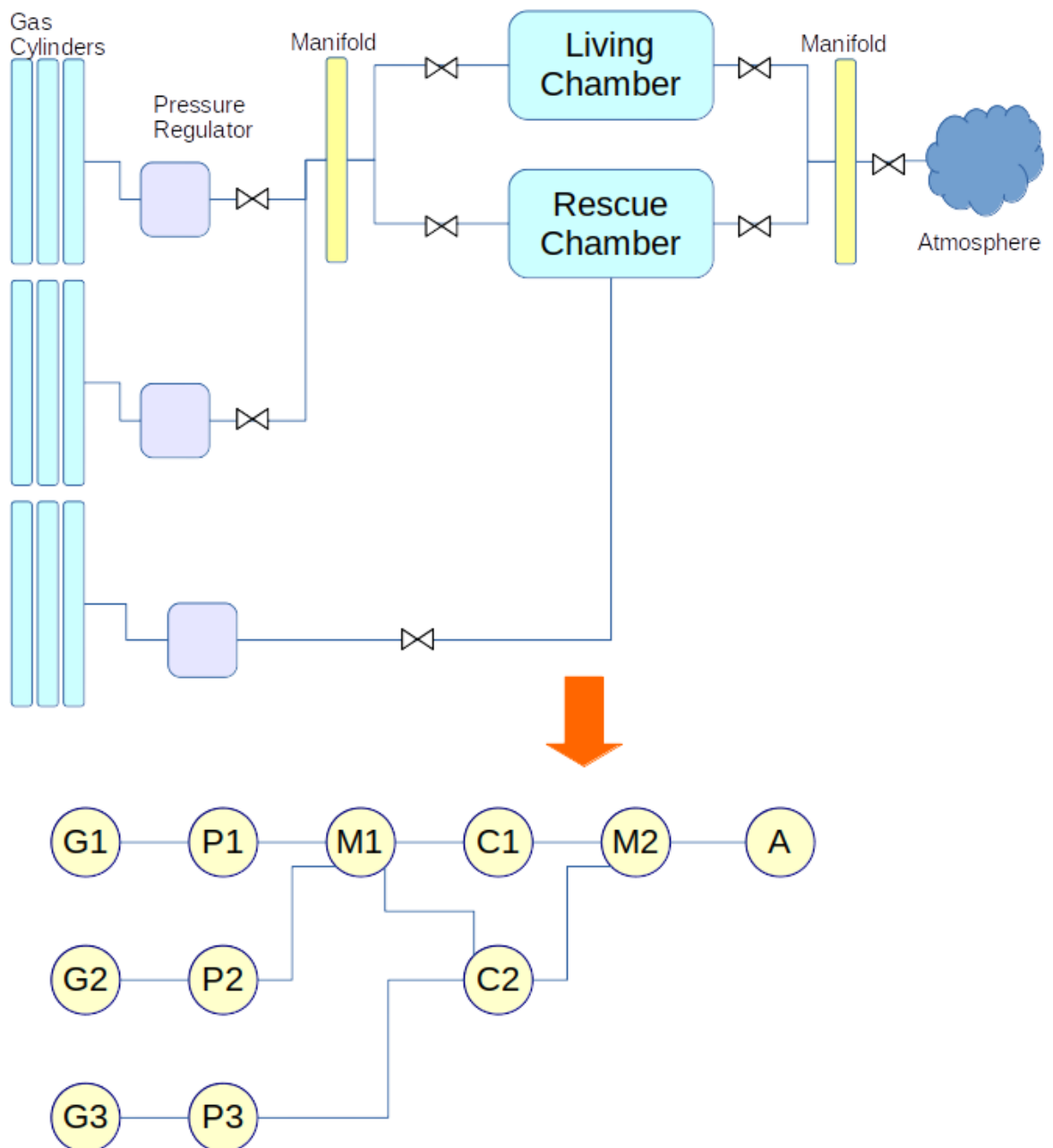


Figure 6-1. Representation of gas distribution system (part) as a mathematical graph

To describe an ideal gas flow inside a tube at subsonic speed Bernoulli equation can be used

$$Flow = \sqrt{\frac{2(P_1 - P_2)}{\rho}} S_{TUBE}$$

where  $P_1$  and  $P_2$  are pressures in two nodes,  $\rho$  is a density of gas in a node with highest pressure and  $S_{TUBE}$  is a cross-section of a tube. It is important to consider an aperture angle of a valve, which affects cross-sectional area of a tube. In case of a sphere valve it can be done multiplying calculated flow by

$$S_{VALVE} = S_{TUBE}(1 - \cos(\alpha)) = \pi \frac{d^2}{4} (1 - \cos(\alpha))$$

where  $\alpha$  is an aperture angle of a ball valve.

Presented above flow equation has obvious limitations caused by properties of the gas distribution system. Indeed, taking into account gas viscosity, effects caused by turbulent flow, tube and joint rugosity and other parameters, it is possible to setup an upper bound of speed of gas in pipes, which was confirmed by experimentation conducted in collaboration with subject matter experts.

In order to avoid errors caused by too big calculation time step, which is equal to 10ms and could be too long in case of rapid transitory processes, such as break of a pipe and sudden fast gas leakage. To address such issue, the calculation of flow employs Riemann sum to find numerically gas flows (Davis & Rabinowitz, 2007), which foresees division of the initial time interval in steps of reduced duration. In this particular case it was decided to divide intervals by 2 at each iteration  $k$ :

$$\Delta t = \frac{(t_{new} - t_{old})}{2^k}$$

Hence, first iteration is done using time interval  $\Delta t$ , while the consecutive ones could be  $\Delta t/2$ ,  $\Delta t/4$ ,  $\Delta t/8$  etc. When applied to the gas flow, the method performs immediately two calculation steps, one with time interval  $\Delta t$  and another with  $\Delta t/2$ , consequently comparing results. Than the difference between obtained values is compared to be less than 10%; if so, the flow calculation is decided to be completed and the last obtained value used to address mass transfer and further recalculations related to gas and thermodynamics. Otherwise, following iterations with higher  $k$  are invoked; to address possible errors,  $k$  is limited by maximum value equal to 10.

In order to prevent modifications of the plant state during operations, capture and restore of atmospheric parameters is implemented using Memento pattern (Gamma et al., 1994). Indeed, this technique allows to take a snapshot of an object/class and restore it later without violating its encapsulation. In case of the gas model it allows to store state in the nodes' internal classes, perform calculations of flows in connecting pipes and to restore or not initial state based on necessity to perform additional iterations. Indeed, in case when remaining error is small enough, the last calculated state remains and the calculation proceeds with another pipe and pair of nodes. Considering this, the calculation process could be illustrated as presented in the following flow chart.

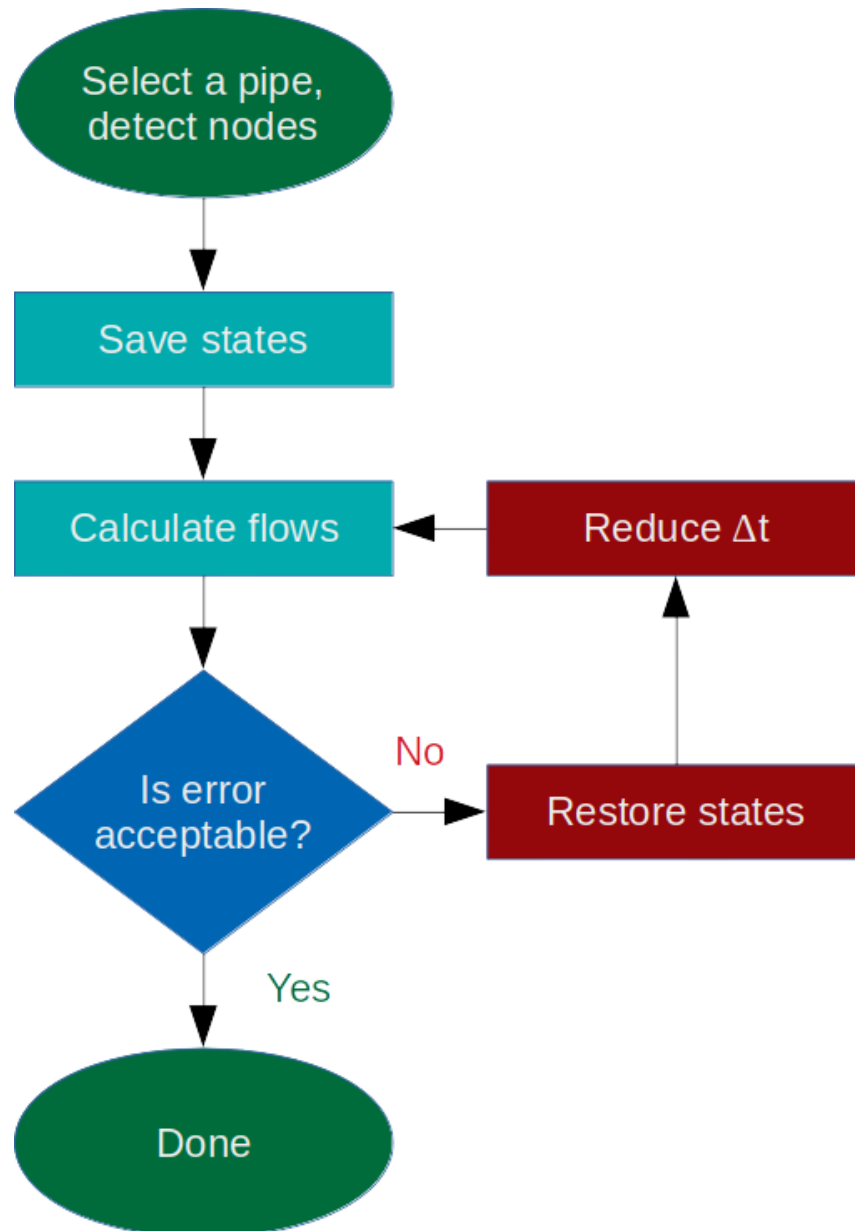


Figure 6-2. Flow calculation sequence.

The next figure illustrates process of creation and reverting processes performed implementing Memento pattern. It is possible to observe, that a Node object is capable to create an instance of Memento class which contains values that must be saved; when required, external client could call this procedure as well as that one required to restore previous state. In case if entire state should be transmitted to other participants it would be convenient to serialize the objects of interest, which would facilitate data exchange. However, in this case this requirement is absent, hence, faster procedure consisting of copy of object variables to provide save & restore functionality is implemented (Maeda, 2012).

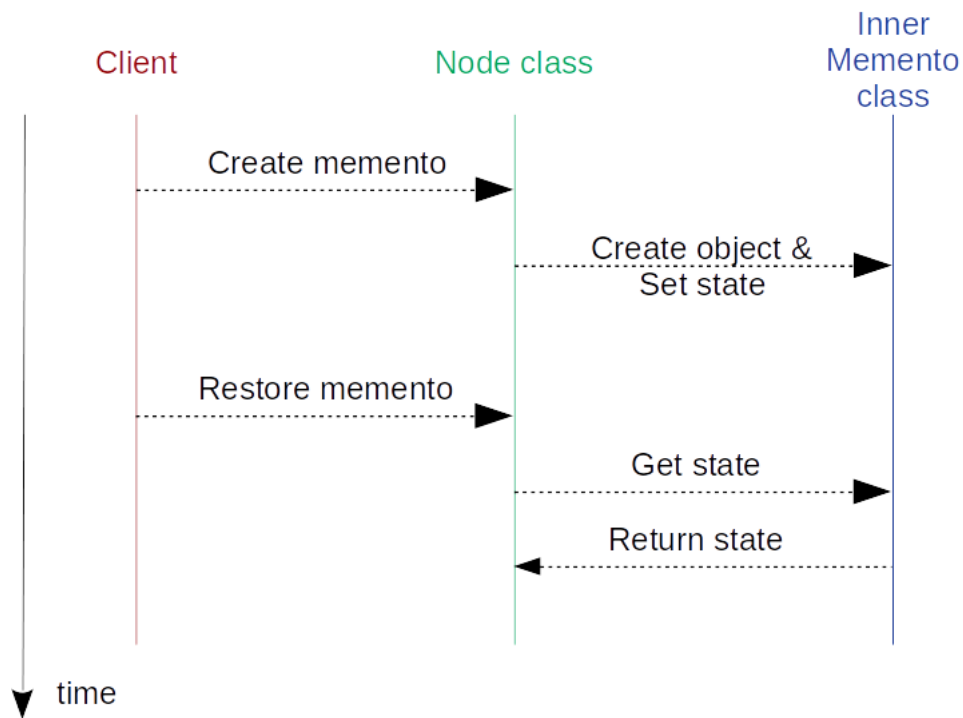


Figure 6-3. Memento pattern implementation in gas simulation

Another critical parameter of the plant is temperature inside chambers. Typically, it is affected by climate control unit, presence of divers and some equipment as well as by variation of pressure caused by compression and decompression. The last factors could have less impact on final temperature, however, basic model which reflects variation of temperature is required.

In this case, to calculate a temperature  $T$  inside chambers and other volumes ideal gas equation is chosen

$$T = \frac{PV}{m\bar{R}_S}$$

where  $P$  is a pressure inside a volume  $V$ ,  $m$  - mass of gas and  $R_S$  - medium specific gas constant. To perform the calculation, it is necessary to know absolute pressure in a volume, mass of gas mixture and medium specific gas constant, which is obtained using following formula

$$\bar{R} = \Sigma R_i c_i$$

where  $R_i$  are specific gas constants and  $c_i$  are mass concentrations of these gases. Same equation is used to recalculate total pressure in a node after some gas has been transferred. Another important thing is calculation of gas mixture's temperature after a mixing, for example temperature in ML after some oxygen is supplied. To calculate the new temperature, it is required to know heat capacities  $C$  of both mixtures, which can be obtained as

$$C_\Sigma = \Sigma c_i m_i$$

where  $C_i$  and  $m_i$  are gas heat capacity and mass. Knowing initial temperatures of both gas mixtures  $A$  and  $B$  it is possible to obtain new temperature using following equations

$$t_{NEW} = \frac{t_A C_A + t_B C_B}{C_A + C_B}$$

These formulas describe all physical process in the plant, so it is possible to define each flow, hence complete mass transfer and the temperature in every volume.

Apart from modification of atmospheric composition by gas distribution system and operation of hatches, there are several other mechanisms which affect environment inside the plant:

- Oxygen consumption by divers
- CO<sub>2</sub> production by divers
- Utilization of shower and water vapour generation
- Discharge of blackwater and pressure loss
- Heating by humans
- CO<sub>2</sub> elimination by scrubbers

Indeed, while atmospheric conditions affect divers, the opposite influence is very important as well. Considering this, the research project analyses gas dynamics and human behaviour and physiological models as parts of one unique solution rather than separate models.

In particular, sitting quietly and completely relaxed person indicatively consumes 3,5 ml of oxygen and produces 17 cal of heat each minute for each kilogram of his or her body weight (Hills et al., 2014). Meanwhile, a worker without particular physical activity consumes on average 4,13-4,29 ml of oxygen per minute per kg of body weight (Matsuo et al., 2020). Finally, during sport exercise a man without special athletic preparation, which is the case for most of the divers), consumes circa 35 ml of oxygen per minute per kilogram of body mass (Heyward, 1998). Another important aspect is CO<sub>2</sub> production, which in case of low intensity activity is equal to 3,5 ml per minute per mass of body weight (Loer et al., 1997). Finally, there are numerous studies on oxygen consumption during swimming, which identify oxygen consumption between 50 and 75 ml per kg of body weight in one minute, hence, taking average value of 62 and multiplying it by oxygen density equal to 1,428 g/L it is possible to obtain expected oxygen consumption equal to circa 6,2 g/min (Sousa et al., 2014). Considering average diver weight circa 70kg and that density of oxygen is 1,428 g/l and applying linear approximation to missing data, it is possible to estimate following values for oxygen consumption and heat and CO<sub>2</sub> and heat production rates.

*Table 6-1. Human oxygen consumption, heat and CO<sub>2</sub> production rate.*

Activity	Oxygen consumption, g/min	CO <sub>2</sub> production, g/min	Heat production, cal/min
Relax	0,35	0,26	1200
Low intensity activity, e.g. paperwork	0,42	0,3	1400
Physical activity	3,5	2,6	12000
Intensive activity (swimming)	6,2	4,6	21000

The value of oxygen consumption in case of low intensity work corresponds to the design rules done by NASA, which indicate a metabolic consumption of oxygen by a crew member as 0,84 kg/day or 58 g/min (Jones, 2003).

The CO<sub>2</sub> scrubbers are designed to be capable to compensate any reasonable amount of gas produced by crew, so until their cartridges are exhausted it is safe to assume that their absorbing capacity covers the production.

This information is fundamental in order to implement functional gas and thermodynamics of a hyperbaric chamber. Considering this, the instructor must have possibility to assign certain status to divers in order to modify their breath and heat production.

## 6.2. Plant Initialization

As mentioned the plant is represented as a mathematical graph. One of advantages of this approach is easiness of its configuration. Indeed, it is sufficient to provide a configuration file which identifies nodes (chambers, trunks, manifolds, atmosphere outside) and corresponding arcs (tubes with valves). For example, following block of configuration file is responsible for generation of main lock:

```
<node id="4">
  <type>2</type>
  <init_pressure>1.0</init_pressure>
  <init_temp>298</init_temp>
  <volume>13.7</volume>
  <init_o2>0.23</init_o2>
  <init_he>0.0</init_he>
  <init_co2>0.0</init_co2>
  <init_n>0.765</init_n>
  <init_vapor>0.01</init_vapor>
  <name>ML</name>
  <corba>ML</corba>
</node>
```

Here, every node has its unique ID, which is essential for its connection with other ones, type (0 – manifold, 1 – pressure regulator, 2 – chamber, 3 – auxiliary connector), initial absolute pressure (bar), initial temperature (K), volume (m<sup>3</sup>), initial percentage of gases (<init\_o2>, <init\_he>, <init\_co2>, <init\_n> and <init\_vapor>), human readable name (<name>) and textual name for data exchange with other models (<corba>).

At the next step every node is connected by pipes with valves, which are taken from the same file. For instance, following tube represent hatch which connects main lock and escape trunk leading to HRC:

```
<tube id="69">
  <diameter>0.5</diameter>
  <node_1>4</node_1>
  <node_2>10</node_2>
  <default_angle>0</default_angle>
  <name>Equipressione ML-Escape_trunk</name>
```

```
<corba>Hatch[ML-Escape_trunk-eq]</corba>
<type>valve</type>
</tube>
```

Each pipe is characterized by its id, diameter (m), indication which nodes it connects (<node\_1> and <node\_2>), default aperture angle of the integrated valve, human readable name for controls, name for interoperable communication (<corba>) and type (<type>). Other important systems created in the virtual plant during initialization are Hyperbaric Conditioning Unit (HCU) and CO<sub>2</sub> removing scrubbers. They are initialized in following way:

```
<cooling_unit id="0">
  <node_id>4</node_id>
  <max_power>1200</max_power>
  <corba>HCU[0]</corba>
</cooling_unit>
```

Indeed, each unit has its id, node in which it is installed, max cooling and heating power and name for data exchange (<corba>). The scrubbers are represented in the following:

```
<scrubber id="0">
  <initial_node>7</initial_node>
  <name>TUP Scrubber</name>
  <corba>Scrubber[1]</corba>
</scrubber>
```

Similarly to HCUs, scrubbers have id, node id where they are located initially (in case they are moved even if this is not foreseen in the scenario), human readable name (<name>) and data communication identifier (<corba>).

Divers are initialized using similar technique. In this case their id, name and data exchange identifier are included:

```
<diver id="0">
  <initial_node>4</initial_node>
  <name>Diver 1</name>
  <corba>Diver[1]</corba>
</diver>
```

During the development of gas simulation and initialization systems it was created also a mechanism that generates representation of the plant in DOT format. This graph description language and set of visualization tools allow to produce following images which represent interconnections between different parts of the plant, discarding their mutual physical location.



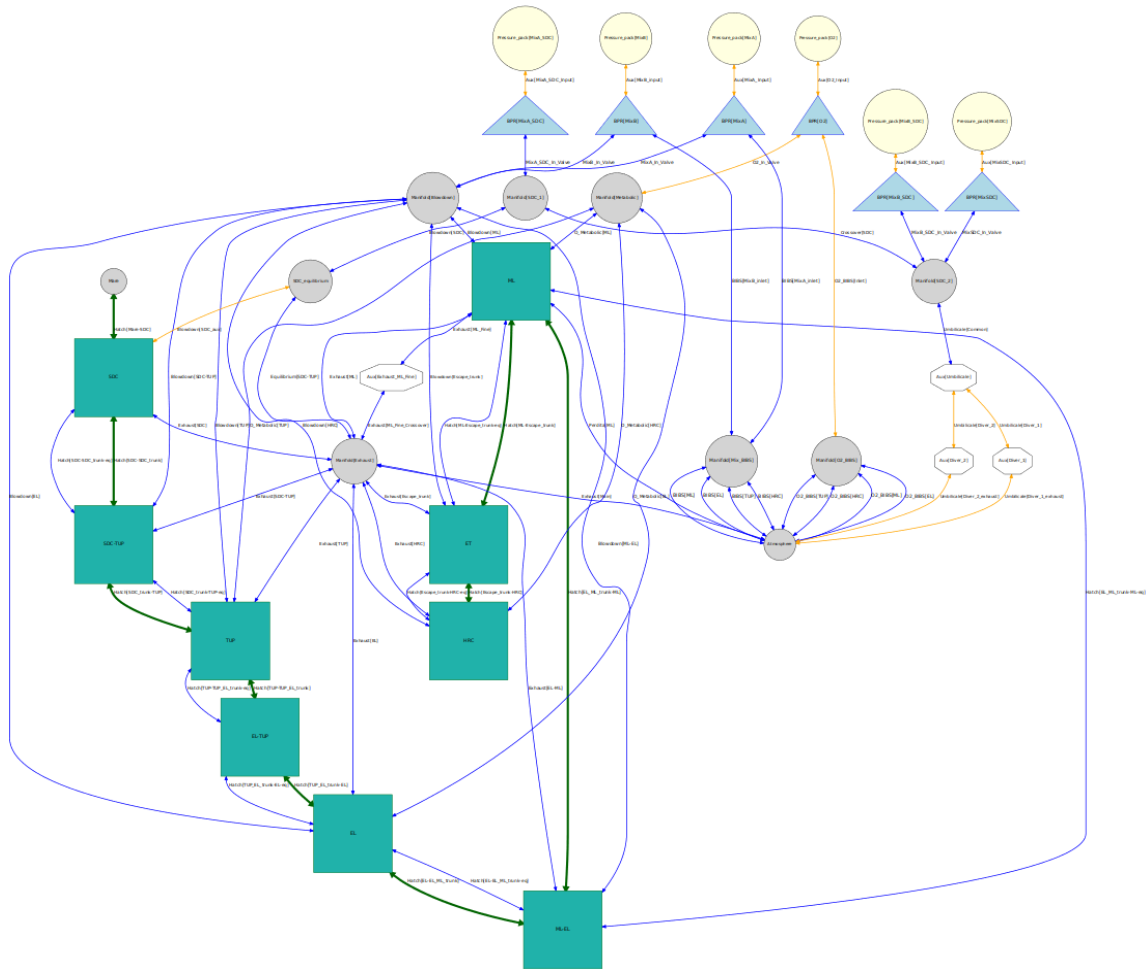


Figure 6-4. Interconnections of different parts of the gas distributed system.

For instance, in the image it is possible to observe gas cylinders (light yellow circles on top), pressure regulators (triangles), manifolds and auxiliary connections (grey circles) and locks with trunks (green squares).

### 6.3. Physiological Reactions and Human Behaviour

In many cases, simulation allows to significantly improve human safety by analysing processes and performing more effective training. In fact, to maximize its positive effect, influence of LSS's decisions on divers' health must be considered. Obviously the quantity of physiological factors which could cause effects on diver is enormous and their implementation could require a lot of resources, while most of them have very limited effect or rare impact considering that the divers are selected people with excellent health. In addition, some pathologies in real life would require detailed interaction with medical doctors and it is not required to train the LSS on such issues. So it's necessary to choose several most important factors considering field of application of a simulator and real effects on quality of training.

After analysis the different health care cases the following main elements were identified to be modelled for the simulation: barotraumas, hypoxia, hyperoxia, carbon dioxide poisoning, nitrogen narcosis, hypothermia, hyperthermia and various problems caused by contamination.

These disorders, which are summarized in the next, are caused by atmosphere composition, temperature and pressure change rate, hence during simulation health indexes of every diver are calculated using data about current and previous states of the plant, for example concentration of oxygen in last 10 minutes.

*Table 6-2. Principal Disorders included in the simulation*

Disorder and Sickness	Cause based on Simulated parameters	Effects and Symptoms presented by virtual simulation
Barotrauma	Pressure variation in time	Ear pain; Pain in front or cheekbones
Vertigo	Pressure variation in time	Vertigo Nausea
Hyperoxia	Oxygen concentration	Uncontrolled movements
CO2 poisoning	CO2 concentration	Breathing difficulties Respiratory spasms Loss of consciousness
Hypoxia	Oxygen concentration	Shortness of breath
Narcosis	Inert gas concentration (Nitrogen, Hydrogen)	Small tics and convulsive phenomena
Hypothermia	Temperature	Shivering
Hyperthermia		Sweating

From this point of view virtual humans driven by agents could be used to reproduce pathology evolution in the simulator (Bruzzone et al., 2012).

It should be outlined that in some cases it's difficult to provide enough data to decide if certain medical condition should be applied; for instance, hypoxia could be caused by stratification of atmosphere inside the chamber in case of low gas circulation rate. Another example is contamination which could be caused by different agents placed inside the chamber, usually transported from out of the plant after the completion of an underwater work shift. For these reasons, it could be more effective to generate, some of these disorders, manually by direct commands from the instructor's control panel. For instance, he could inject within a simulated virtual diver the symptoms of hypoxia to check trainee reaction. However, it's important to distinguish events generated automatically from these introduced by the instructor; from this point of view is useful to block inconsistent situation, for example, to avoid that a simulated diver presents barotrauma symptoms while there is no any pressure change in that zone.

As mentioned, some disorders' symptoms are triggered by the simulator based on analysis of current and previous states of diver and the plant. To provide such functionality it is possible to use several techniques, starting from simple if/else logic and up to neural network. However, due the fact that performance is one of crucial requirements of the real-time system and that each disorder is typically caused by variation of one single parameter, it is decided to trigger disorders' symptoms basing on results of 'straightforward' calculations. To illustrate this logic lets analyse cases of hyperoxia and barotrauma.

As shown in the table, hyperoxia occurs when oxygen concentration in the chamber with diver exceeds limits, which are typically imposed by pressure inside. Hence, the simulator must calculate such limits in every single moment for every diver, compare them with actual values and save these data for future calculations. As shown in the following equation, exceeded concentration  $C_E$  in moment  $t$  is equal to the difference between measured concentration  $C_M$  and maximum allowed concentration  $C_{Max}$  at pressure in the moment of measurement  $P(t)$ , but only when measured value exceeds the maximum one.

$$C_E = \begin{cases} C_M - C_{Max}, & C_M > C_{Max} \\ 0, & C_M \leq C_{Max} \end{cases}$$

During next steps, the system performs integration of these values, compare result with given limit and, if necessary, trigger symptoms, in this example it makes divers perform uncontrolled movements. This process, which performs integration of difference between maximum and actual oxygen concentration in last 20 minutes, as shown in equation, where  $A$  is accumulated exceeded value.

$$A = \int_{T-20min}^T C_E(t) dt$$

Due the fact that time is discrete, this equation is represented as sum of differences between observed and maximum concentrations during samplings multiplied per time step  $\Delta t$  between them. In this example time step is equal to 1 minute, however it could have any reasonable duration. Hence, previous equations should be expressed in new form, where  $C_M(N)$  - measured concentration during sampling  $N$ ,  $C_{Max}(P(N))$  - maximum concentration allowed at pressure  $P$  measured during sampling  $N$ . In case of saturation diving maximum concentration of oxygen decreases with pressure, for instance it is less than 10% at pressure which corresponds to 200m depth.

Accumulated value, obtained using this formula is used to estimate intensity of this typical disorder. For instance, value near or equal to zero will not cause any symptoms, while big positive one would correspond to injure or even death. Of course, it is possible to take in consideration also time passed after measurement, for example by multiplying samples by coefficient reversely proportional to the time passed, which would reduce importance of older samples.

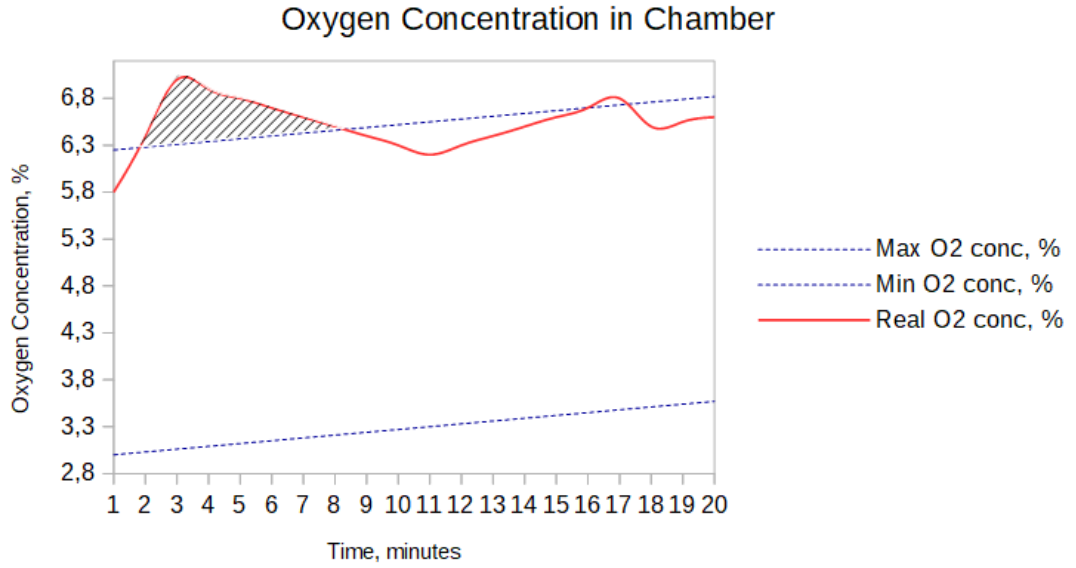


Figure 6-5. Example of gas concentration log, with excessive value shown in dashed area

Process of calculation is illustrated in figure above, where shaded area A corresponds to the accumulated value, calculated when measured concentration  $C_M$  exceeds the maximum one  $C_{MAX}$ .

$$C_E(N) = \begin{cases} C_M(N) - C_{MAX}(P(N)), & C_M(N) > C_{MAX}(P(N)) \\ 0, & C_M(N) \leq C_{MAX}(P(N)) \end{cases}$$

$$A = \sum_{N=-20}^0 C_E(N) \Delta t$$

Hyperoxia itself is rare in real plants, however described logic is applicable for some of other pairs of parameter & disorder, such as hydrogen concentration & narcosis otherwise temperature & hypothermia. In the last case, for example, divers are becoming more sensitive to 'uncomfortable' temperature at high pressure.

Another interesting scenario is related to fast pressure variation in chamber, which occurs sometime during both normal and emergency operation. This case is similar to the previous one, with major difference that instead of considering pressure value in given moment it is necessary to calculate its variation in time, as presented in following equations.

$$P_E(t) = \begin{cases} \left| \frac{dP_M(t) - dP_{MAX}(P_M(t))}{dt} \right|, & \left| \frac{dP_M(t)}{dt} \right| > \frac{dP_{MAX}(P_M(t))}{dt} \\ 0, & \left| \frac{dP_M(t)}{dt} \right| \leq \frac{dP_{MAX}(P_M(t))}{dt} \end{cases}$$

$$A = \int_{T-20min}^T P_E(t) dt$$

where  $P_E(t)$  - exceeded pressure change rate,  $P_M(t)$  - measured pressure in moment  $t$ ,  $dP_{MAX}$  - maximum allowed pressure change rate at given pressure and  $A$  - accumulated exceeded value of pressure change rate, which is used to trigger different symptoms. Important to notice that maximum acceptable pressure difference depends on actual pressure; typically, at high pressure (de)saturation rate is very slow, about 0.1bar in one minute. Another important consideration is that pressure change rate affects divers in case of both compression and decompression, hence absolute value of pressure variation in time must be taken into account. However, response of human body to compression and decompression is slightly different, so to improve precision of the model it could be useful to introduce additional coefficient which would change 'weight' of exceeded pressure samples depending on which of these cases is observed.

As the next step, due the discrete nature of time in simulation, it is necessary to replace integration in time by sum of samplings, which lead to following equations.

$$P_E(N) = \begin{cases} \frac{P_M(N) - P_M(N+1)}{\Delta t} - \frac{\Delta P_{MAX}(P_M(N))}{\Delta t}, & \frac{P_M(N) - P_M(N+1)}{\Delta t} > \frac{\Delta P_{MAX}(P_M(N))}{\Delta t} \\ 0, & \frac{P_M(N) - P_M(N+1)}{\Delta t} \leq \frac{\Delta P_{MAX}(P_M(N))}{\Delta t} \end{cases}$$

$$A = \sum_{N=20}^0 P_E(N) \Delta t$$

where  $P_M(N)$  - pressure value measured during sampling  $N$ ,  $\Delta P_{MAX}$  - maximum allowed pressure change in time  $\Delta t$  between two samplings,  $P_E$  - exceeded pressure change rate.

As well as in previous example time step is considered to be 1 minute and number of samples to analyze is equal to 20. Furthermore, it is possible to perform multiplication by time step in equation, which allows to represent them in more readable form, as presented in the following

$$P_E(N) = \begin{cases} |P_M(N) - P_M(N+1)| - \Delta P_{MAX}(P_M(N)), & \text{if } |P_M(N) - P_M(N+1)| > \Delta P_{MAX}(P_M(N)) \\ 0, & \text{if } |P_M(N) - P_M(N+1)| \leq \Delta P_{MAX}(P_M(N)) \end{cases}$$

$$A = \sum_{N=20}^0 P_E(N)$$

In case when accumulated value  $A$  is more than zero, virtual divers are showing symptoms of barotrauma, for instance in case of value close to 0 they simply inform the LSS about ear pain, while at higher values nausea symptoms and even bleeding are shown using 3D representation of the plant.

Process of calculation is presented in the figure, shaded area corresponds to the accumulated value.

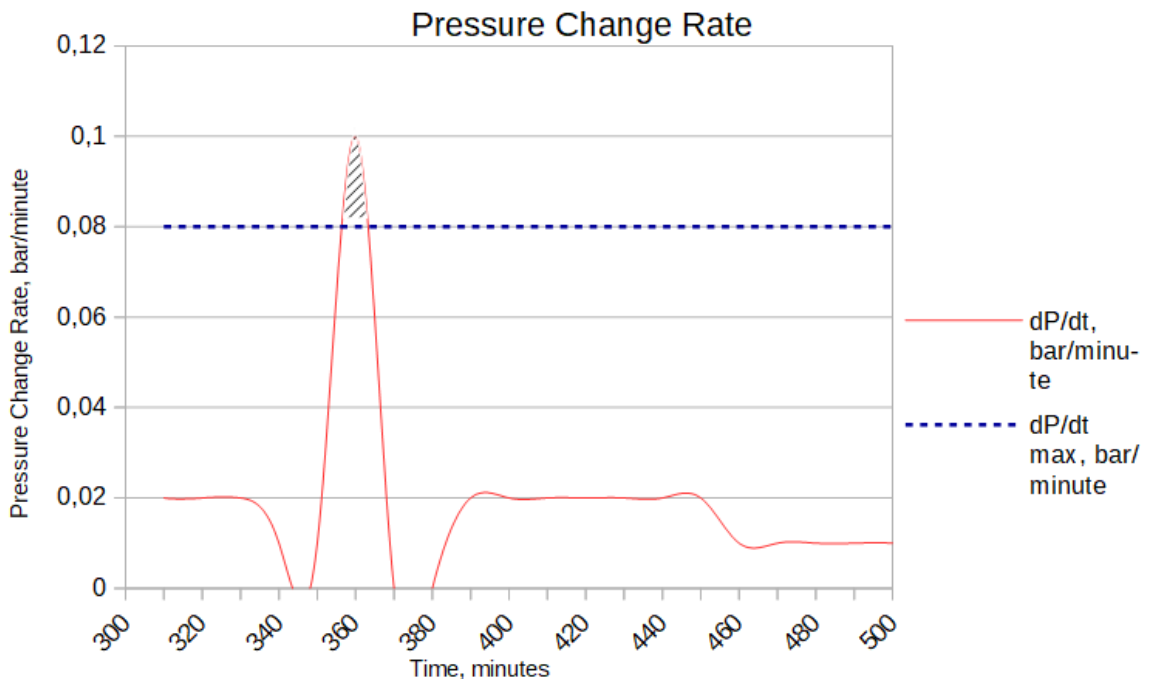


Figure 6-6. Example of pressure variation log with excessive value shown in dashed area

This examples illustrate approaches to trigger symptoms of disorders listed in the table. For instance, barotrauma and vertigo both depend on pressure variation in time and controlled in a way presented in second example, while all other scenarios covered similarly to the first example, with difference that in cases of hypoxia and hypothermia instead to compare current values with upper bound of acceptable range, minimum bound with corresponding correction of boundary condition's sign is used.

In the simulator the limit values for each disease of interest is introduced by means of a XML (Extensible Markup Language) configuration file. Indeed, for each sickness there is following block of settings:

```
<disorder id='5'>
  <corba>barotrauma compression</corba>
  <sign>>false</sign>
  <coefficient_1>1030</coefficient_1>
  <coefficient_2>-0.0000000879</coefficient_2>
  <parameter>p</parameter>
  <pressure_rising>1</pressure_rising>
  <level_1>100</level_1>
  <level_2>200</level_2>
  <level_3>500</level_3>
  <symptoms_1>Ear pain</symptoms_1>
  <symptoms_2>Ear pain, lack of balance, weakness</symptoms_2>
  <symptoms_3>Vomiting, unconsciousness</symptoms_3>
</disorder>
```

First, each disorder has its identification number (id), corresponding unique human readable name for data exchange (corba), exponential coefficients which approximate limit-value as function of depth and pressure (coefficient\_1, coefficient\_2), sign which indicates if normal value should be higher or lower than the curve, parameter to be tracked (e.g. O<sub>2</sub>, P), pressure trend (increasing – 1, decreasing – 0, both - 2) which is used for instance to compare compression and decompression rates with corresponding different acceptable values, 3 levels (level\_1, level\_2, level\_3) and corresponding symptoms <symptoms\_1, symptoms\_2, symptoms\_3> which determine at what exceeded value which symptoms should be triggered. This configuration allows easy introduction of new disorders in the simulation and even automatic modification of data exchange system.

The idea to represent variation of acceptable levels of parameters as function of pressure can be illustrated using following example of compression. Indeed, taking previously mentioned acceptable values for compression speed, choosing central depth of each range and converting it to corresponding absolute pressure and expressing compression rate in Pa/second it is possible to obtain following table.

*Figure 6-7. Acceptable compression rates at different pressures.*

Absolute pressure, Pa	Compression rate, Pa/s
1100000	1500
5600000	500
15600000	150
30100000	100

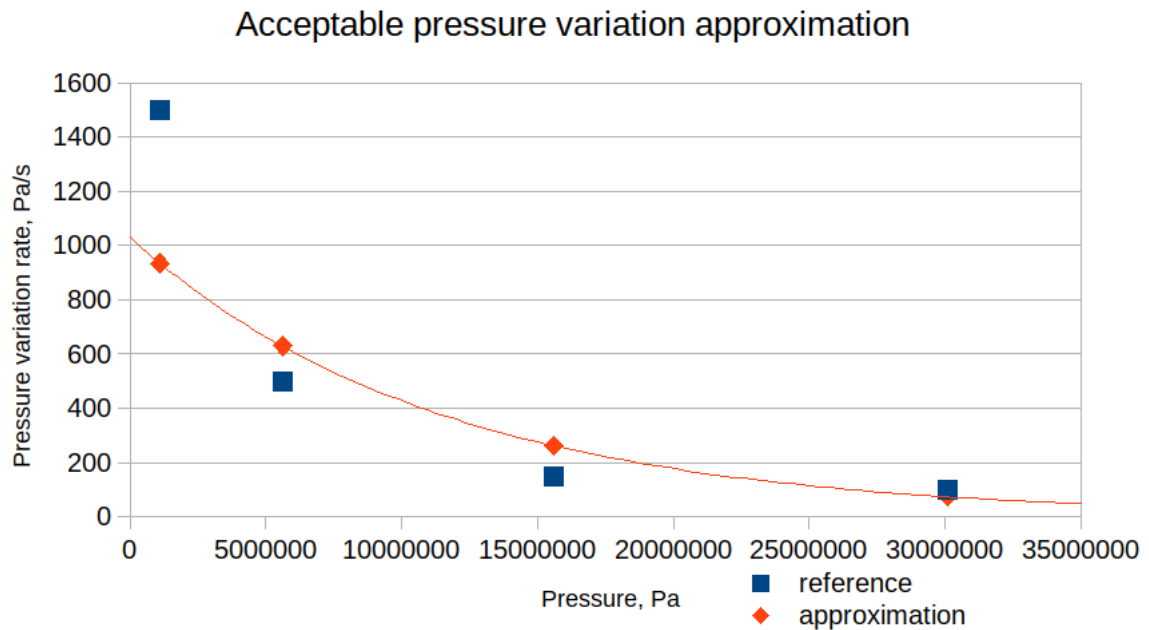
These reference values are quite approximate and at the next step must be converted to an exponential equation which would represent compression rate  $C$  as function of pressure  $p$ , such as:

$$C(p) = a_1 e^{a_2 p}$$

In this case, the curve is not expected to have best fitting to the points but to have realistic trends; indeed, all parameters of interest vary linearly or exponentially with pressure, so all equations must be checked to not have physically unrealistic behaviour, such as negative predicted values (all variables in model are non-negative, such as absolute pressures and absolute temperature). Considering this and that the range of interest in terms of pressure lies between 0 and 300 meters of sea water, coefficients of the previous equation could be:

$$\begin{cases} a_1 = 1228 \\ a_2 = -1,18 * 10^{-7} \end{cases}$$

The points provided in the table and interpolated curve are presented in the following.



*Figure 6-8. Acceptable pressure variation approximation.*

Hence, for each diver the simulator can take actual pressure of surrounding atmosphere, check previous value of pressure, calculate acceptable variation based on obtained function and evaluate if the difference falls in range of normal values. If not, difference between normal and acceptable values is taken into account to evaluate possible physiological reaction and symptoms. Other diseases and corresponding symptoms are calculated using the same method. The approximations and acceptable levels were chosen in collaboration with experts in diving medicine and actual life support supervisors.

Another effect considered by the gas model is relation between pressure and temperature, for instance decreasing of the pressure at 1 bar in the simulator leads to the temperature drop for about 1 K, which corresponds to the variation observed during operation of real plants. Normally this effect is negligible, however, during some emergency situations, a LSS can encounter a problem when to compensate fast pressure losses and restore normal pressure value, it is necessary to blow inside the plant big amount of gas, which leads to sensitive temperature variations, in this case fast drop with subsequent increasing. Furthermore, in contrast to "normal" conditions outside, where variations of temperature for several degrees don't cause any significant effect but only discomfort, inside the plant such change of atmospheric conditions could lead to hypo- or hyperthermia. Hence, in these situations LSS could face dilemma: restore pressure fast and seriously heat divers inside, otherwise restore it slowly but cause barotrauma of personnel. For obvious reasons training of the supervisors on empty plants can't demonstrate consequences of such decisions and, of course, there is no ideal solution, however simulation of human disorders would prepare supervisors to face and mediate this kind of emergencies.

Simulation of gas dynamics allows not only to improve training of future life support supervisors, but also to develop new safety procedures and adjust existing regulations. Indeed, possibility to evaluate different strategies of problem remediation without putting at risk human lives or equipment is a powerful tool capable to speed up evolution of safety and efficiency in this field.



## 7. The Simulator

The simulator is a complex system composed of a number of sub-systems, devoted to recreate various aspects of the plant functionality, including behaviour of divers and malfunctions.

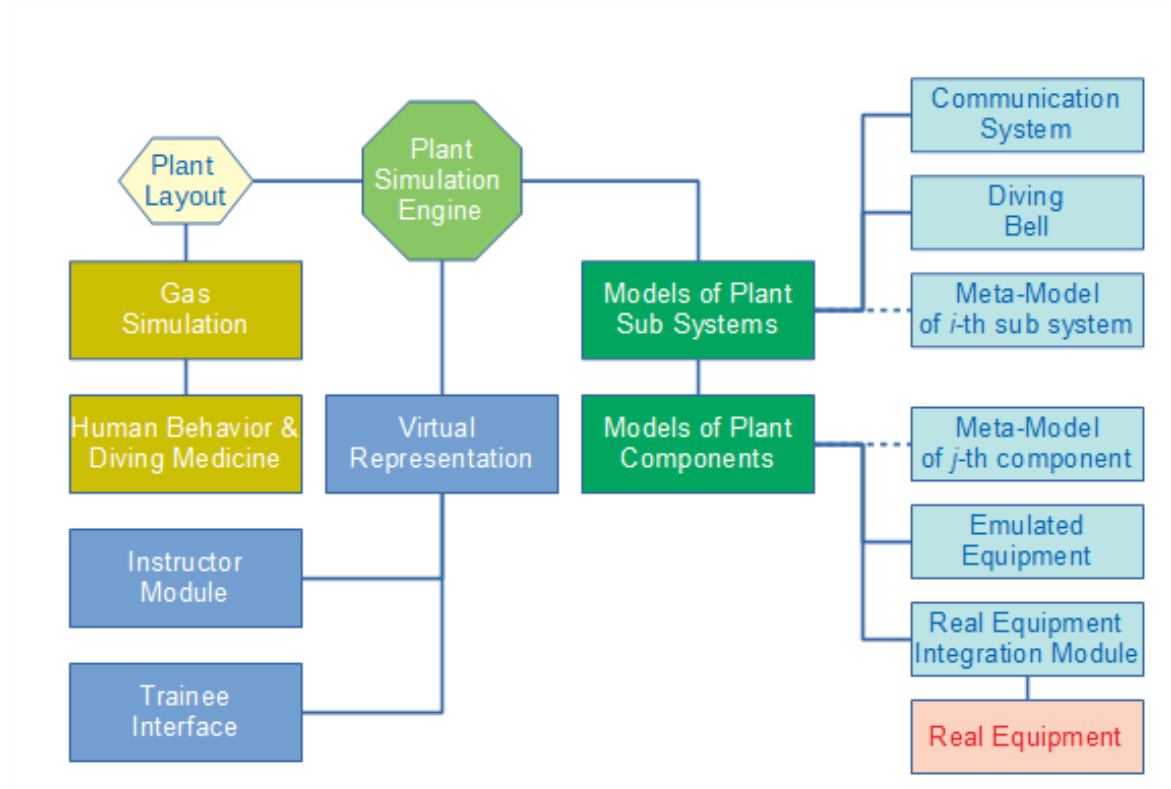
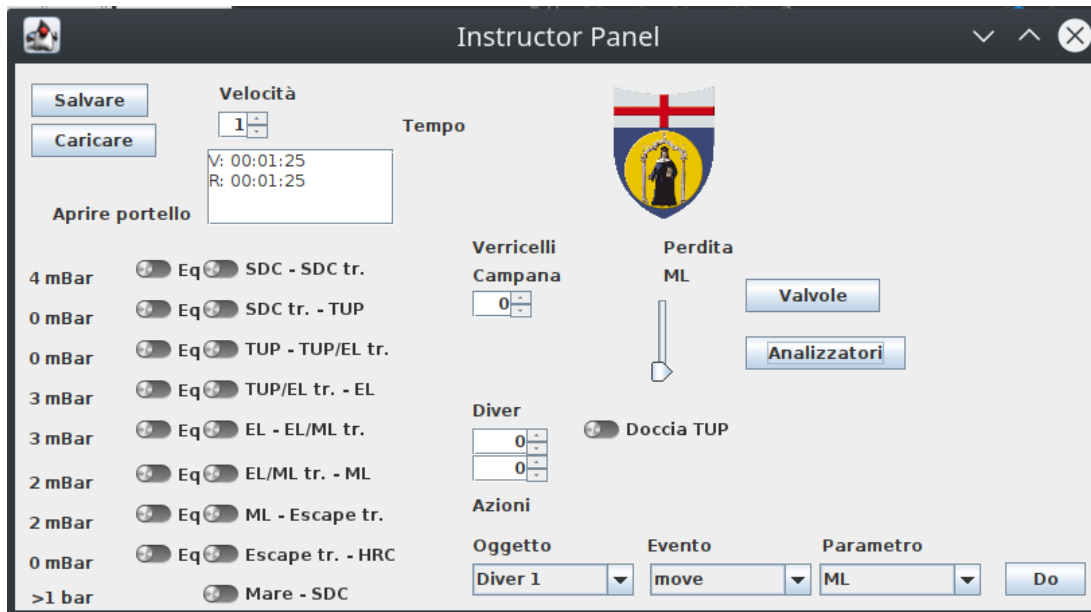


Figure 7-1. Interaction between simulator's sub-models and sub-systems

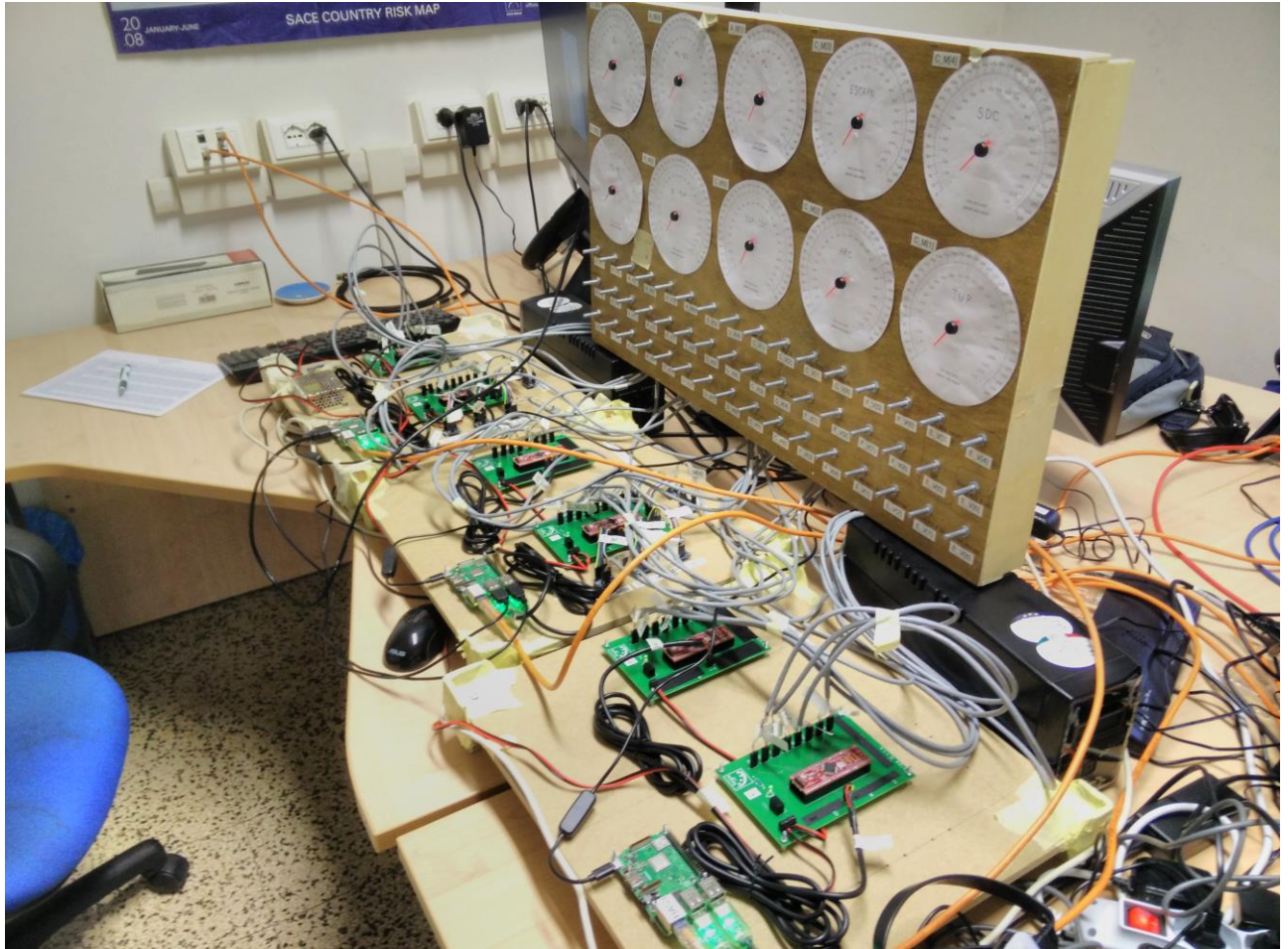
### 7.1. Instructor and User Interfaces

The simulator foresees different mechanisms of interactions with trainer and with trainee. Indeed, while for the trainee it is essential to have a realistic copy of a real control panel and equipment, the instructor requires possibility to check system's information regardless similarity of his interface to any real system. However, in order to facilitate development, it was decided to keep configuration of controls similar to that one seen in a real plant. In particular, the instructor is enabled to act on simulator using his or her control panel, shown in the following figure, while having possibility to open auxiliary panels in order to keep control on actual state of the simulated plant. Indeed, it is possible to open a panel representing state of the valves and pressure regulators as well as another panel with atmospheric analyzers, as explained in the following.



*Figure 7-2. Instructor's main control panel.*

While the instructor's interface is purely digital, the trainee's controls are required to be physical in order to obtain proper level of certification for training. The trainer's interface is implemented using Swing toolkit for Java. Considering this, since the first stages of the project it was started development of a prototype of a control panel. In particular, it is required to check feasibility of proposed mechanism of data acquisition, handling and visualization, to analyse interference between the system and other devices, power consumption, presence of electronic noise, delays in reading data from sensors and their transmission etc. In the following image it is presented an early version of the prototype, which was used for integration tests as well as for verification and validation. Indeed, even this simplified interface allowed to acting LSS to provide feedback on behaviour of gas model, analysers and controls as well as to give recommendations and suggestions for improvements.



*Figure 7-3. Control panel prototype for integration testing*

## 7.2. Time Management

One of functions available to the instructor is time management, which allows to change time multiplier used by the gas model and to set one of following time scales:

- Real time.
- Pause.
- Fast time, up to 10x faster than real time.

While first two modes are essential for normal operation, the last one is required mostly for demonstration purposes as well as to reduce time required for validation of the gas model.

## 7.3. Loading and Saving of Scenarios

One of principal functions of the instructor's panel is loading and saving of scenarios. Indeed, this function allows to load up a desired scenario or situation (e.g. start of decompression, pressure loss in a chamber, docking of the bell etc.) as well as to save actual state of the system. Furthermore, the program performs periodic automatic saves without interventions from the instructor. In this cases the program utilizes files which are similar to that

ones for the plant initialization and resets actual state of the simulated facility: gas concentrations and temperatures, location of divers and bell, aperture of valves and hatches, health state of personnel, saturation of scrubbers etc.

Hence, it is possible not only to load a training scenario but to save the actual one in order to be able to return it in the future, for instance, to try to find better solution for a problem.

#### 7.4. Hatches Control

One of routine operations in the plant is opening of the hatches and locks, which is usually done when divers need to move in another chamber; for instance, it is used during docking and undocking of the bell, material and food passing as well as in other normal and emergency operations.

An important consideration related to the operation on locks is pressure difference between its sides. Indeed, based on area of a hatch and pressure difference, it could be impossible to open it. For example, if diameter of a round hatch is 50cm (area of almost 0,2 m<sup>2</sup>) and even small pressure difference such as 10kPa (1/10th of atmospheric pressure), force required to open it would be

$$F_{open} = P * S = 10000 * 0,2 = 2000N$$

In comparison, an average person in comfortable position (object in front, slightly lower than the head), could pull at 200N of force, while pushing force could be as high as 500N (Garg et al., 2014), which would make opening a hatch physically impossible. Indeed, this principle is used in passenger aircraft, where plug doors are maintained closed thanks to the pressure difference: little movement inside is required before hatch can be opened in outside direction; the differential pressure in cabin is usually maintained 55kPa higher than the outside one (Emmerman, 1988), while considering surface of the door of 1,5 m<sup>2</sup> in case of Airbus A320 (Airbus, 2005) gives more than 80 kN required to open it mid-flight, which is again lies far beyond human capabilities.

If in a real plant these aperture and closure operations are done by divers in cooperation with the LSS. In particular, the supervisor checks that pressures are almost equals at both sides of a hatch, adjusts it in case of necessity and instructs the divers to open it. Obviously, LSS cannot set absolutely equal pressures, so special valves are present inside the plant to allow equilibration. Considering this, the divers use them in order to be able to open doors and move between chambers, trunks and locks.

In the simulator trainer plays role of divers and acts on hatches on locks. For this reason, the instructor's panel has possibility of equilibration of pressure and of opening of hatches. Meanwhile, additional indicators to show pressure difference are included.

#### 7.5. Supervision on the Plant's State

One of main functions of the control panel is possibility to conduct detailed supervision of trainee. For instance, available panels allow to control values of pressure and atmospheric composition in different parts of the simulated plant by means of a virtual panel, which has configuration similar to its physical counterpart, as shown in the following figure.

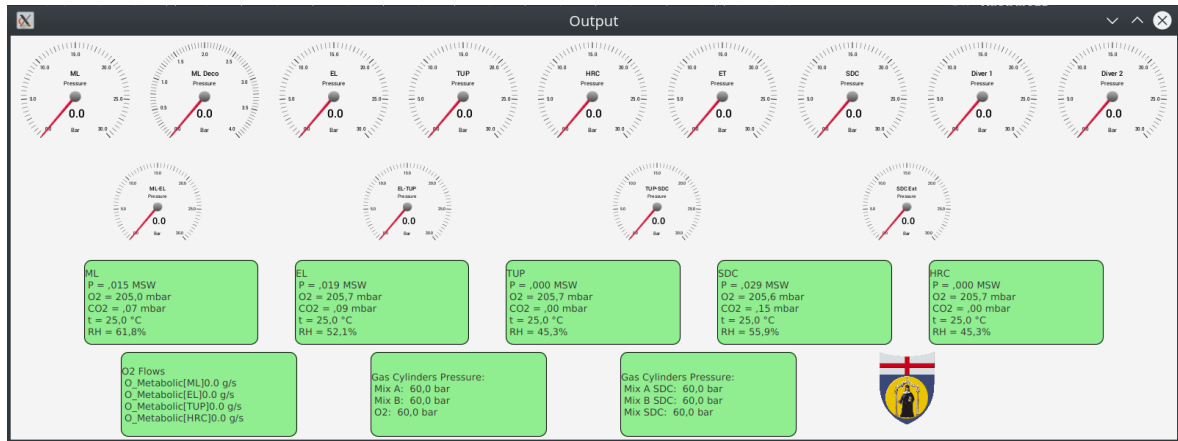


Figure 7-4. Gas analyser control panel.

Indeed, the panel includes all pressure gauges, analysers of atmospheric composition and flow meters that the real panel has. In order to benefit from modern collections of widgets, in particular gauges, JavaFX toolkit was used for this panel (Grunwald, 2016). In order to check actual state of the valves set by the trainee, it is possible to utilize dedicated Valves panel, shown in the following figure. It includes all controls available to the trainee, including blowdown and exhaust valves, pressure regulators, BIBS and conditioning unit controls. While the instructor is enabled to see status of all physical valves on control panel mock-up, it is not possible to modify it. Indeed, it would introduce inconsistent and non-realistic behaviour. However, it is a very useful tool for supervision of trainee.

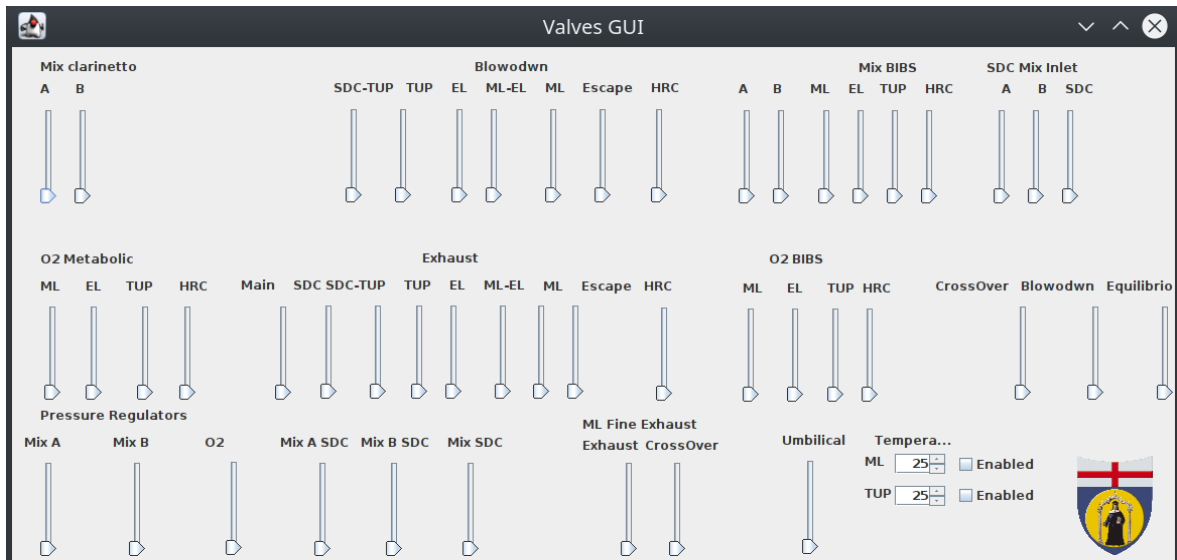


Figure 7-5. Valves and conditioning unit controls.

## 7.6. Operation modes

The developed solution allows following operation modes:

- LSS training. In this mode the instructor is enabled to act on plant only using dedicated Instructor panel, while panel with valves only visualizes actual state of the valves, while its modification is blocked in order to avoid inconsistent situations (e.g. physical valve is opened while the virtual one is closed).
- Standalone. In this case the simulator works without any interaction with other models and systems and allows to the user to modify also states of the valves; no consistency problems could be present. The networking is completely disabled. This mode is required mostly for demonstration purposes and for debug of the gas model during its development.
- Publish-only. This mode allows full control on virtual panel with valves, all updates are shared but not received. This regime is intended for some hardware setting and integration testing procedures.
- Read-only. Contrary to the previous one, this regime makes the gas model invisible for other participants but allows to visualize all existing in the system values.

The publish-only and read-only regimes are usually used together to test data exchange. Indeed, in this case it becomes easy to evaluate correctness of codification, transfer and decodification of data without necessity to employ other sub-systems and simulators.

## 7.7. Plant Controls

In order to provide sufficient level of control on the plant and the divers, a special mechanism of actions is introduced. Indeed, it allows to order to a diver to move in another room, trigger symptoms or start an emergency. In order to call these actions, the instructor to choose and object of control (e.g. diver), event which is need to be done (e.g. move) and parameter (e.g. destination). This approach allowed creation of a unique configuration file which includes dependencies between objects, events and parameters, as shown in following examples.

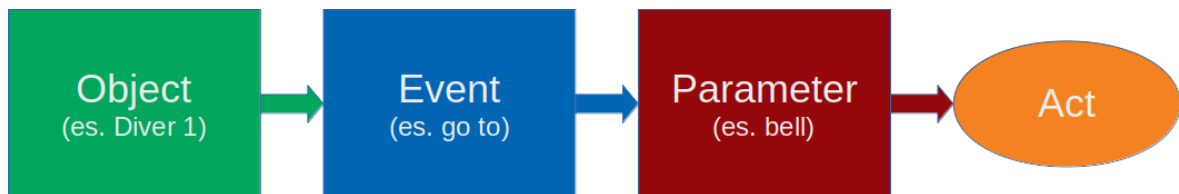


Figure 7-6. Command sequence

```

<object id='0'>
  <type>diver</type>
  <name_corba>Diver[1]</name_corba>
  <name_gui>Diver 1</name_gui>
</object>
  
```

Presented entry defines object called “Diver[1]” which has its type and visible name. Meanwhile, its type (<type>) is used in order to determine possible events. Indeed, it is important to distinguish between possible categories of assets in order to avoid meaningless commands (e.g. move entire plant in a chamber or stat fir in diver).

```

<event id='0'>
  <type>move_diver</type>
  
```

```

    <name_corba>MOVE_TO</name_corba>
    <name_gui>move</name_gui>
    <possible_objects>diver</possible_objects>
</event>

```

The event entries define action (<name\_corba>) which could be applied to object of types listed in <possible\_objects>. Similarly to the previous case, entry <type> is used to link this event with its parameters provided in the following.

```

<parameter id='0'>
    <name_corba>ML</name_corba>
    <name_gui>ML</name_gui>
    <possible_events>move_diver</possible_events>
</parameter>

```

Finally, parameter describes missing details of event. In this case it specifies that possible event “move\_diver” could be used to direct selected diver in ML (Main Lock) – living room of the plant. In some cases, parameter could be unnecessary.

This configuration data is loaded on start of the simulator and allows to the instructor to act on the plant by using automatically updated drop-down menus.

## 7.8. Auxiliary Functions

Among other functions, the trainer’s interface allows to change depth of the bell and of divers respect to the bell. In this case the trainee observes variation of external pressures as well as corresponding updates in simulated video.

In order to simulate utilization of shower the instructor can activate special mechanism which causes increase in humidity by releasing water vapour inside the plant. In the same time, several valves for simulation of leakages are installed. They connect several critical parts of the plant directly to the external atmosphere in order to create artificially pressure drops. Hence, the trainee is required to address them acting on control panel (increasing gas flow) and communicating with technical staff of the plant (e.g. asking to close external valves) and divers inside (e.g. instructing to move to another chamber or to try to close internal valves). In any case, all external communications are done with the instructor, who could stop emergency when required.

## 7.9. Integration and Interoperability

The developed solution is quite complex and includes numerous systems, sub-systems and simulators. Considering this, one of principal challenges was the proper integration in order to guarantee required interoperability. During the initial phase of the project it was supposed to provide data exchange and time synchronization by means of High Level Architecture (HLA) as presented in the following figure.

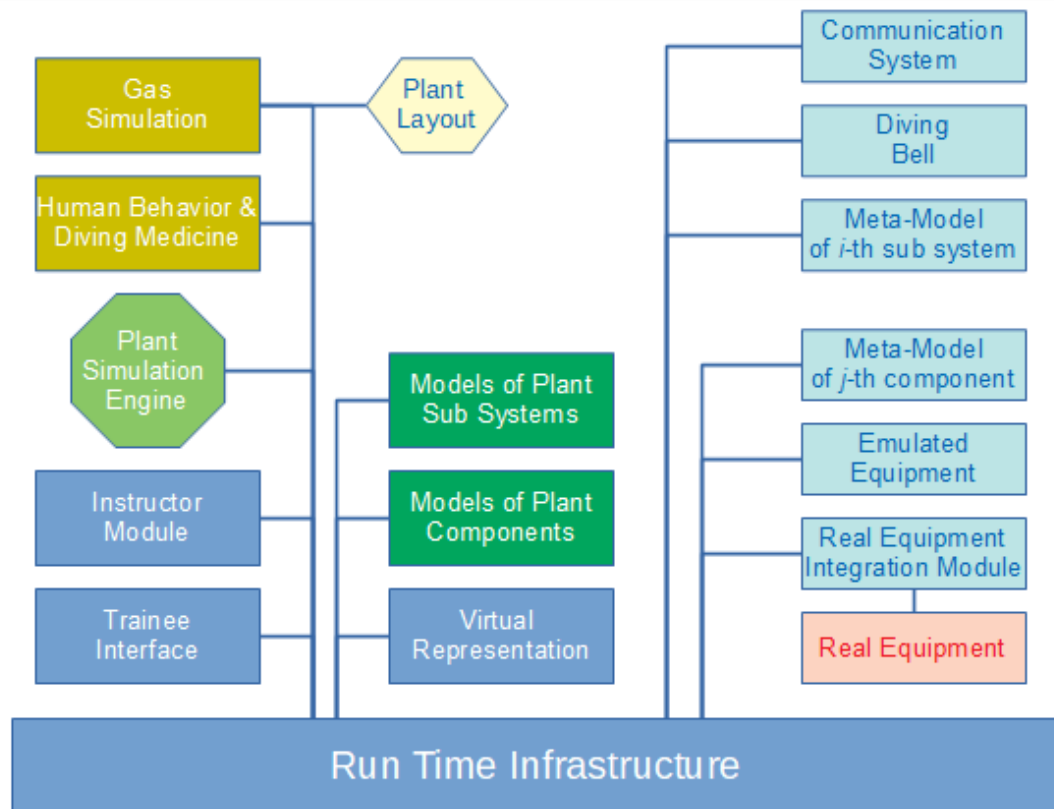


Figure 7-7. Interoperability by means of HLA

However, several issues are arising. First, all computer in the simulator are running Linux-family operation systems, while most of available Run Time Infrastructures (RTI) are suitable to work only with Microsoft Windows or with deprecated Linux distributions, hence, a dedicated Windows machine to run RTI would be required. Another issue is related to the utilization of virtual environment for simulation of 3D representation of the hyperbaric plant; indeed, Unity engine and C# programming language were chosen to implement it, but this technology has no direct integration with available and supported RTIs. Last but not least, other stakeholders of the project were not familiar with this technology.

Due to these considerations it was decided to utilize previously developed ad-hoc data exchange application, based on Remote Procedure Call (RPC) and in particular on CORBA (Common Object Request Broker Architecture) (Spiegel, 2000). CORBA is a standard for communication between applications developed by OMG (Object Management Group) and in the past it was widely used for inter process communication (IPC) in Unix family of operation system, before being replaced by D-Bus (Love, 2005). In order to guarantee proper calls CORBA uses special files written in specific Interface Definition Language (IDL) (Mangler, Schikuta & Witzany, 2009). For example, following code declares that all participants handle basic requests such as “init”, “start” and “stop”:

```
module Application {
    interface ControllerInterface {
        oneway void init ();
        oneway void start ();
        oneway void stop ();
    }
}
```



```
};
};
```

Each participant of the common network than uses this configuration file and uses it to generate language-specific implementations, which are guaranteed to be correct. Obviously, further handling of these commands is left to the user and implementation varies between different functional modules and programming languages.

In similar way, every participant uses same data types identified in the file; in particular, in the project all messages are decided to be strings or long integers, which allows avoiding of well-known floating point precision and number representation problems (Muller et al., 2018; Goldberg, 1991). Obviously, in this case all transmitted values must be represented as integer number; for example, pressure information is expressed in Pascal, while presence of gases is indicated in grams. Furthermore, enumerator type fields were added to guarantee that status of different sub-systems is verbose and human readable, for example:

```
enum State {
    APP_READY,
    APP_RUNNING,
    APP_ERROR
};
```

Following table summarizes main parameters exchanged between systems.

*Table 7-1. Example of exchanged variables and their units of measurement*

Variable	Unit of measurement	Variable	Unit of measurement
O <sub>2</sub>	g	Tube area	mm <sup>2</sup>
CO <sub>2</sub>	g	Valve aperture	%
He	g	Pressure regulator value	Pa
N	g	Pressure	Pa
Water vapor	g	Volume	cm <sup>3</sup>
Temperature	cK, centiKelvin	Humidity	%

In order to avoid potential problems caused by floating-point representation of numbers, it was decided to express all exchanged values as integer numbers. In some cases, it caused utilization of non-standard units of measurement but their multipliers, e.g. centi-Kelvin and cubic centimetres.

The used implementation includes some principal functionality of HLA, for example it allows to publish send data to the server to be available when necessary, otherwise to notify all subscribed participants about it. The first case allows to avoid overhead caused by transmitting excessive data, for example between gas model which updates state of hundreds of components each 100ms and gas analysers which need data only for several parts of the plant with sampling period near 1 second. Publish/subscribe functionality, otherwise, is useful to notify simulator sub-systems about events, which could be opening of a hatch or start of a sickness of one of virtual divers.

Hence, even if ad-hoc solution was chosen as base for distribution simulation, its core functionality is corresponding to that one of HLA.

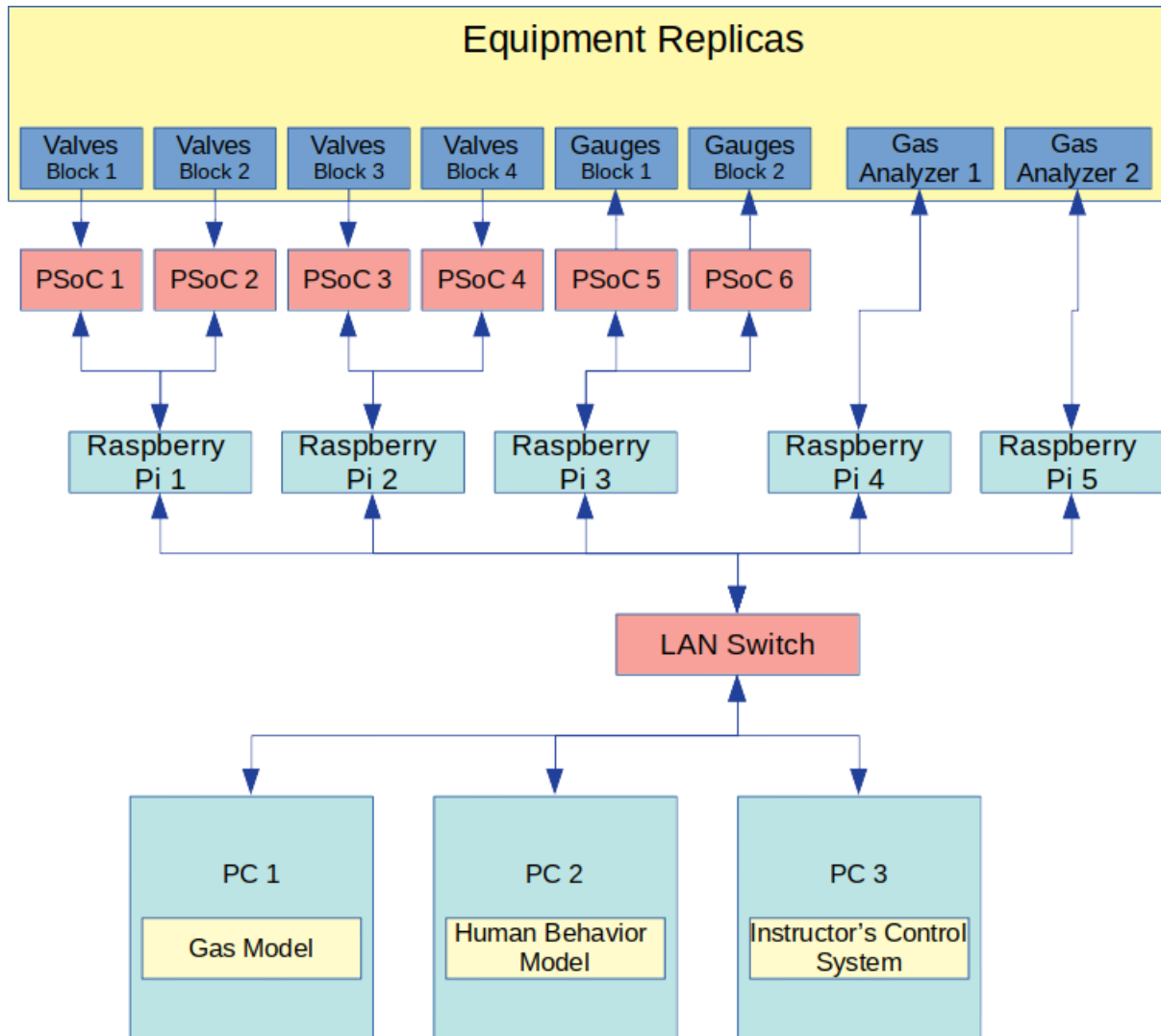


Figure 7-8. Principal physical connections among devices

The simulator is characterized by presence of multiple controllers, single board computers and traditional PCs. In particular, as presented in the following figure, in order to control all valves (near 100 units) and pressure gauges (10), 6 Programmable System on Chip (PSoC) controllers are required (Mohiddin et al., 2011). Due to their limitation in connectivity capabilities, each pair of PSoC is connected to a dedicated single board Raspberry Pi controllers, which in their turn are connected to the network switch. Furthermore, 2 gas analysers are presented in the panel, each one governed by dedicated single board computer. The simulator side of the system is composed of 3 personal computers, dedicated to execution of gas model, human behaviour and physiology model and instructor's control correspondingly. Obviously, the entire system is quite complex and requires numerous power supplies. However, testing shown that this configuration seems sufficiently reliable for everyday use despite presence of numerous signal and power connectors.

In order to reduce construction costs each valve is represented by a voltage divider with potentiometer, hence, controllers are constantly read the voltage value and in case of its variation send the new value to the controller; in the same time, minimal variations which are normally caused by an electronic noise are ignored.

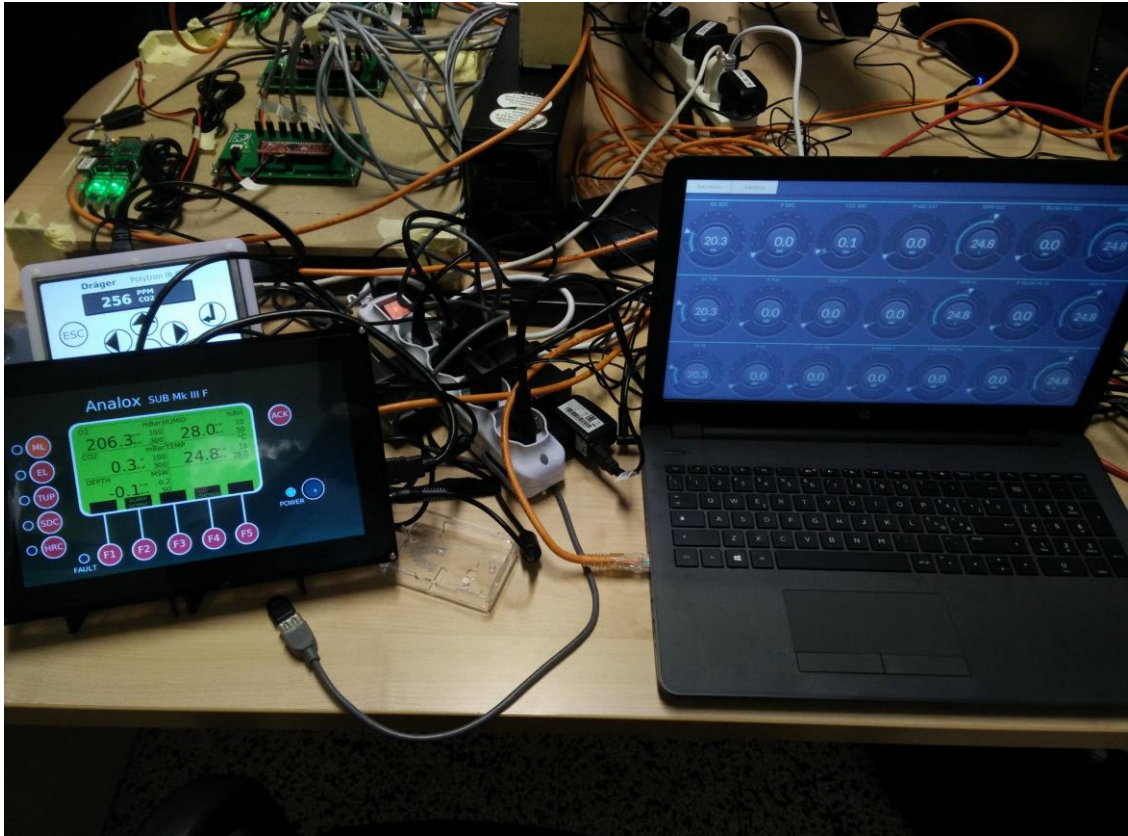
Pressure gauges are commanded by servo motors which allow to not only set exact required values, but also do it in with dynamics similar to that of a mechanical pressure gauge. Drivers of each motor are controlled by a PSoC, which are connected to the corresponding single board computers.

Last but not least, the gas model, human behaviour model and supervisor's control system are running on separate personal computers. While it is possible to execute them all on the same machine, the possible workload variation of the common computer could impact negatively execution of the gas model simulator. All devices connected to the network are sharing the same real time value, guaranteed by presence of a Network Time Protocol (NTP) server (Nemeth et al., 2017).

The usage of PSoC is determined by their structure which combines FPGA (Field Programmable Gate Array) and traditional computational core. Indeed, it allows to create highly configurable data elaboration systems capable to connect dynamically various pins to the ADCs (Analog to Digital Converter). Hence, making it possible to employ all available GPIOs (General-Purpose Input/Output) to the converter and drastically minimize number of required controllers. Indeed, in case of utilization of other types of controllers, e.g. MSP430, which typically have only several ADC channels, the number of required chips would increase several times.

Another important part of training process is communication between trainee and plant personnel, which is played by the trainer. In the simulation it is decided to employ VoIP (Voice over IP) Phones, which are connected to a dedicated Asterisk server (Mahler, 2005). This system is not integrated with other models and sub-systems; indeed, communications are completely isolated. However, it allows to perform logging of calls which is essential for training.

This architecture shown very promising results since the first integration tests. Indeed, immediate and proper definition of units of measurements, names of exchanged parameters and architecture of message exchange system allowed to perform required experimentation. For example, the following image illustrates first integration tests between systems developed by stakeholders.



*Figure 7-9. First integration test combining prototypes of 3 atmospheric monitoring systems and analysers and mock-up of valves and pressure gauges*

## 8. Verification and Validation

The field of simulation started its rapid growth in the middle of the 40s with development of first general purpose computers, such as Electronic Numerical Integrator and Computer (ENIAC) which was build in 1945 (Goldstine & Goldstine, 1946). In the next years, the rapid evolution of computers was accompanied by fast expansion of the field of computer simulation (Goldsman et al. 2010). From the beginning it was clear that one of critical aspects of modelling and simulation is related to accuracy of created solutions. However, despite awareness of necessity to conduct proper tests and perform assessment of models, until end of 60s there was almost no mentioning of model verification methodologies in the scientific literature and in some cases was mentioned only as a problem in the use of simulators (Sargent & Balci, 2017). Indeed, as was noted by Schrank and Holt in 1967, the creation of complex systems and making them usable required so much effort that validation became neglected.

The situation started to change only in the 1970s, which was accompanied by publication of several fundamental works related to the problem of model verification and validation (Van Horn, 1971). Indeed, it became clear that validation must include statistical tests on data, but must not be limited by them and have to include conduction of Turing type tests, prototype and field tests. The issue of correctness assessment became even more evident when U.S. Congress became concerned whether models used by the government are suitable enough for their purposes and lead to development of Guidelines for Model Evaluation by USA General Accounting Office (General Accounting Office, 1979). The document included flowchart with basic steps of the modelling process and included application of verification and validation to the solution, provided definitions and criteria for model evaluation.

Next big step in evaluation of models was done in 1990s with diffusion of affordable personal computers and consequent grow of the interest to the simulation. In this period verification and validation of models became essential requirement for the principal governmental organizations, such as USA DoD (Department of Defense) and more scientific approaches to assessment of the models were defined (Diem et al., 2010; DoD, 2009).

The goal of the research project is to create a simulation based training solution for life support supervisors and to obtain certification for conducting of such activity. Considering this, it is essential that the developed solution satisfies criteria provided by the certification authority.

In the following, it is presented theoretical basis used for verification and validation of the developed solutions as well as results of these procedures.

### 8.1. Theory and Methodology

In order to assure sufficient level of quality-related characteristics, such as accuracy, efficiency, reliability it is necessary to adopt proper methodologies starting from early stage of development project. Considering that the main requirement of the project in order to be certified is related to its accuracy, following assessment activities were adopted to deal with it (Balci, 1997; Vermesan, 1998):

- Verification
- Validation
- Testing
- Accreditation

Verification (to verify, from Latin “verus” which means “true”) is required to ensure that the simulator is built in accordance with its conceptual model, which represents reality with

certain level of approximation. Hence, this process demonstrates or not if the model or simulator is implemented in the right way.

Validation procedure assures that the model satisfies its purpose, for instance, that it behaves in a way similar to a real system. Therefore, if a model provides valid representation of the target system.

Testing asserts errors present in the simulator and is used for verification, validation or both. For instance, it could be walkthrough of a real scenario performed on a model; in the present project this was done, for instance, by active LSS operating the gas model in order to evaluate realism of consequences of actions respect expected behaviour.

Finally, accreditation officially certifies that the simulator can be used for specific purposes. In the project it implies that the certification authority, IMCA, allows its usage for training of LSS.

These activities are usually mentioned together as V&V (Verification & Validation), VV&T (Verification, Validation & Testing) and VV&A (Verification, Validation & Accreditation). Interconnections between verification and validation is illustrated in the following figure.

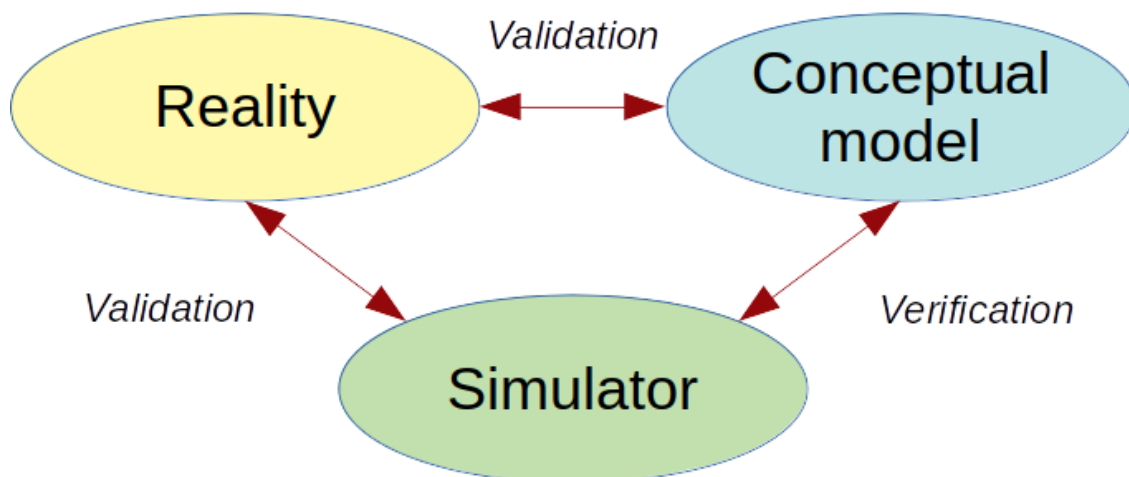


Figure 8-1. Verification and validation.

## 8.2. Model Verification & Validation

In the research project, the main purpose is to train the LSS who must control the life support system of saturation diving plants in order to guarantee the safety of divers and operations; a fundamental aspect is therefore that of reproducing physical phenomena with an accuracy equivalent to that necessary for trainees and which is required by the operational context. In this particular case, dynamic of the systems is relatively slow; however, it was decided to insert physical model capable of operating even in fast time to guarantee the possibility of supporting of different education phases by interactively demonstrating the pressurization and depressurization curves in a short time and to conduct special demonstrations and tests, including exhibitions. In the final solution the time acceleration capability is not foreseen, however, it was included in order to support verification and validation procedures in terms of time reduction.

Another fundamental aspect is the degree of realism of the commands that was decided to implement through the creation of a mock-up control panel connected to the models and sub-systems developed by the stakeholders; the hypothesis of the virtual control interface, vice

versa, was implemented at the heart of the physical simulation for the purpose of testing, verification and validation.

It is also essential to identify the critical target functions for the evaluation of the simulation which in this case refer to the dynamics of the state variables within the nodes that represent the environments of the hyperbaric chambers; in particular, variables of most interest are total and partial pressures and temperature. From this point of view, the simulation allows to carry out experiments on the gas and thermodynamic model in order to identify their behaviour.

The VV&A of the solution is performed continuously since its beginning, conducted with involvement of SMEs and foresees following principal activities:

- Acquisition of requirements from the users
- Development and validation of conceptual models
- Definition of working environment to be implemented
- Test and analysis of results
- Inspection of user interface and check of input and output variables
- Validation of experimental results

For instance, different activities require involvement of different types of experts, as summarized in the following table.

*Table 8-1 Roles and tasks for SME*

SME	Task
LSS	Evaluation of training procedures, definition of tests, control of the interface mock-up and of the virtual plant operation
Diving medicine expert	Identification of disorders, evaluation of behaviour of simulated divers
Scientists	Plant physics analysis, gas and thermodynamic model development and check, implementation of models and sub-systems
Accreditation expert	Support of operations development

All experts were involved in order to support:

- Review of objectives and of the SOW (Statement of Work) of the original proposal and of the actual development plan.
- Walk-through of conceptual models in order to review functional logic.
- Simulator face validation on formal requirements.
- Mission environment and scenario review for identification of training and test processes to be carried out on the simulator.
- Data collection check for consistency respect to the reference plant.
- Scenario walk-through in order to review principal scenarios.
- Implementation checks, code review and debug conducted during implementation by developers.
- Simulator face validation of the user interface and interactions.
- Single model and algorithm face V&V by independent tests on single models.
- Integration testing among different modules, models and sub-systems.

- Conceptual model validation for the completeness in terms of parameters taken into account.
- Preliminary execution testing of the various modules by the various subjects involved in the development.
- Execution testing on the complete simulation system.
- Analysis of variance
- Sensitivity analysis

### 8.3. Compression of the Chamber

Chamber compression is one routine operations in hyperbaric plants and as described previously consists of pressurization of a part of the plant (e.g. chamber, trunk, material passing lock) and contemporary controls of atmospheric parameters, especially pressure and temperature. Indeed, this operation is chosen as the first one to be conducted on the simulator in order to perform preliminary testing and to ensure that the model development is based on correct assumptions.

As illustrated in the following, the simulator allowed to perform pressurization of a small chamber in a realistic way, including first stage in which pressure was slightly increased, pause to detect possible leakages and consequent rise of pressure up to required value. This preliminary testing was conducted on early stage of development and was performed on a virtual user interface.

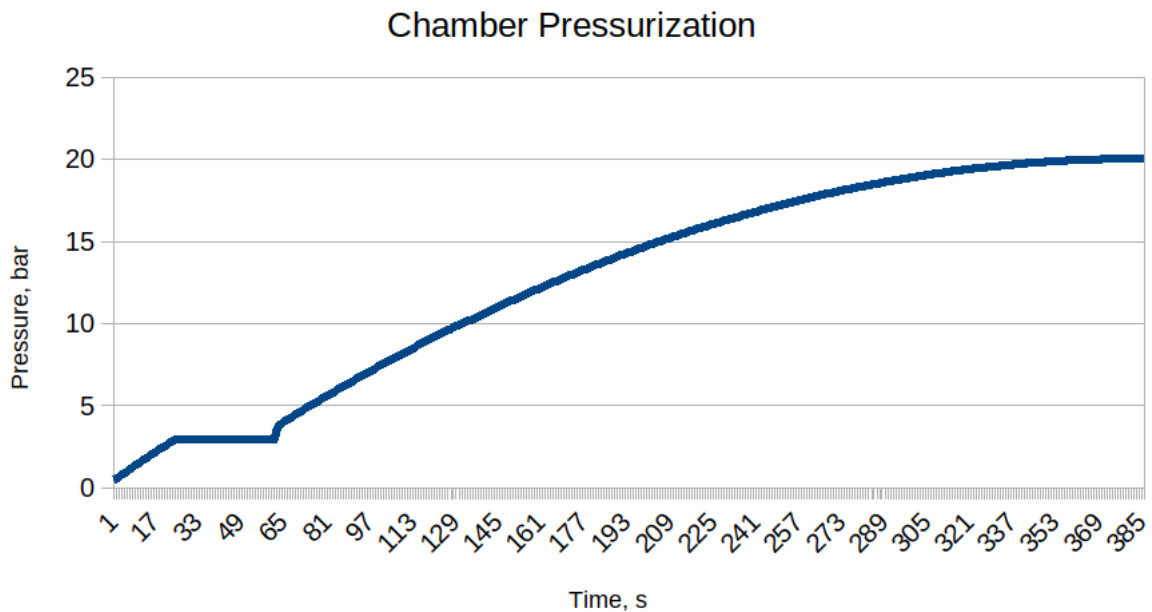


Figure 8-2. Pressurization of a chamber.

### 8.4. Atmosphere Washing

Another similar but more complex procedure is atmosphere washing. It is required when it is detected a potentially dangerous concentration of smoke, CO<sub>2</sub> or another substance which



could harm divers inside. In this case both blowdown and exhaust valves are opened contemporary in order to perform atmosphere substitution with clear gas mixture. In this case the LSS is required to pay attention to maintaining of constant total pressure.

Following chart illustrates how washing could be used to remove CO<sub>2</sub> from a small chamber; in this case the total pressure of gas is circa 20 bar and it is required to reduce CO<sub>2</sub> concentration below acceptable level of 250 ppm. Indeed, initially the partial pressure of this dangerous gas is close to 8 millibars (right scale), which is corresponding to the concentration of 400 ppm of CO<sub>2</sub>.

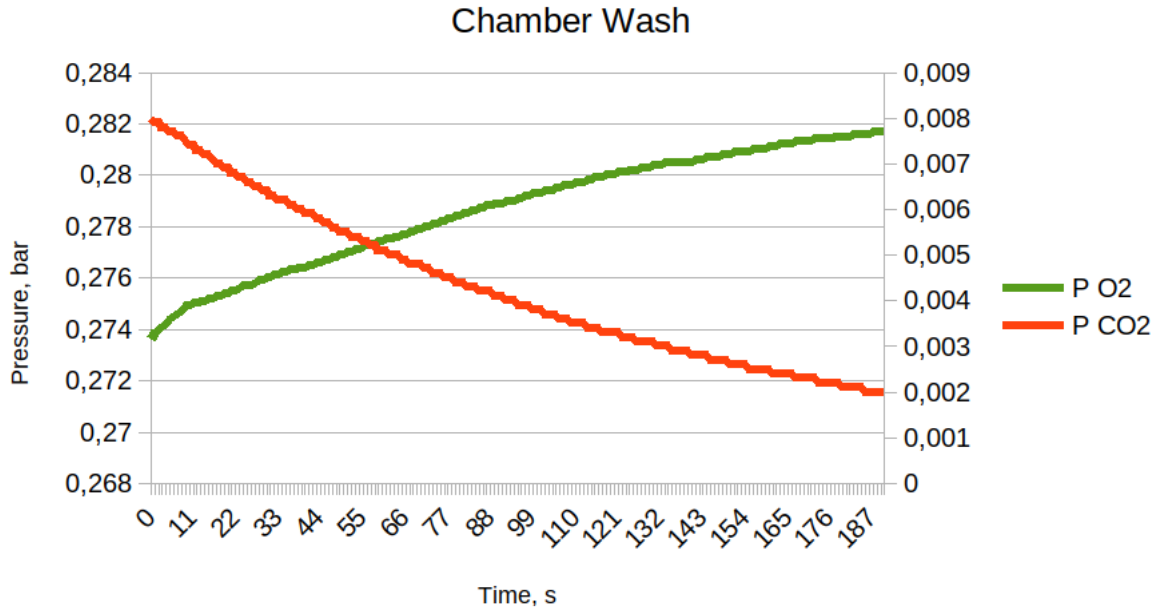


Figure 8-3. Chamber wash

Both tests were conducted involving SME who confirmed realistic behaviour of the plant.

### 8.5. Sensitivity Analysis

The gas model was also subjected to sensitivity analysis in order to evaluate impact of valve aperture angle and conditioning unit on total pressure in a chamber. Following initial conditions were used.

Table 8-2. Initial conditions

Parameter	Value
Initial pressure, bar	4
Chamber volume, m <sup>3</sup>	13,6
Initial temperature, °C	25
Blowdown pipe diameter, cm	2,54
Pressure regulator configured value, bar	25
Gas mixture	Heliox

Following factors are used for the analysis.

*Table 8-3. Factors*

Factor	Value min	Value max
Blowdown ball valve aperture, degrees	30	40
Configured temperature, °C	20	25

Both factors affect the pressure in the system. In fact, increasing the temperature increases the internal energy of the gases and consecutively their partial pressures, while the opening angle changes the effective section of the inlet pipe with the following change in the flow rate and the increase in transferred masses and resulting partial pressures. For this reason, it is possible to analyse the sensitivity of the model by changing the values of the factors and measuring parameters that depend on pressure and its variation, for example the time between the start of the tests and the occurrence of the first symptoms of barotrauma. Therefore, it is necessary to analyse 4 scenarios which correspond to 4 combinations of factors (Montgomery, 2017):

- Blowdown is opened at 30°, HCU works to reduce temperature up to 20°C.
- Blowdown is opened at 40°, HCU works to reduce temperature up to 20°C.
- Blowdown is opened at 30°, HCU works to reduce temperature up to 25°C.
- Blowdown is opened at 40°, HCU works to reduce temperature up to 25°C.

Considering these initial factors and conditions it is possible to analyse the pressure variation in the chamber in 4 scenarios, with the results presented in following figure. From this figure it is clear that the pressure variation is highly dependent and directly proportional to the valve opening angle blowdown, although it is slightly dependent and directly proportional to the temperature, which corresponds to the expected behaviour. Since the gas model is deterministic, it is sufficient to conduct 1 launch for each scenario to obtain these results.

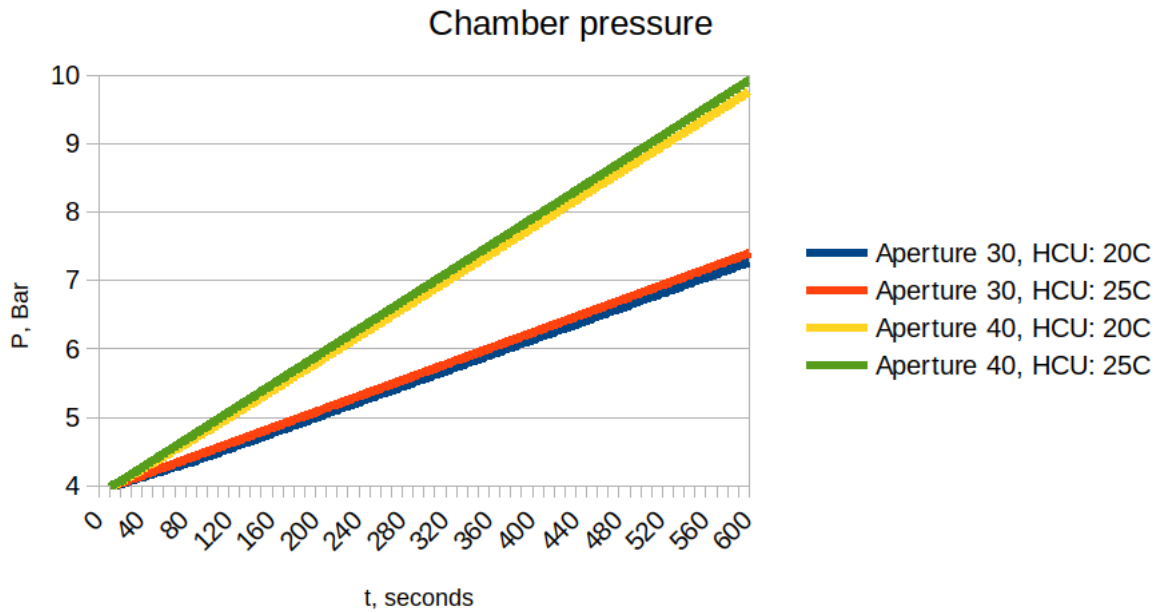


Figure 8-4. Chamber pressure variation at different valve apertures and set temperatures

In this case, due to the short sampling time and the difference between the high pressures, the flow rate remains apparently constant, while in the case of the smallest difference it is possible to observe a slowdown of the flows.

The symptoms of barotrauma depend on various factors, but mainly on the variation in pressure and on individual physiological parameters. For this reason, the calculation of symptoms is based on pressure, but is subject to the influence of stochastic parameters. In fact, in the case when a diver could show a certain level of symptoms, the probability of this event is calculated. For this reason, a total of  $n = 12$  launches for each combination of factors were conducted, with the results of the experiment presented in the following table, where the time of occurrence of the first symptoms in seconds is indicated for each test and combination of factors.

Table 8-4. Testing run results

Factor		Replication												Sum
A	B	1	2	3	4	5	6	7	8	9	10	11	12	
min	min	470	460	460	460	460	460	460	480	460	490	460	460	5580
max	min	40	40	40	40	40	40	40	40	40	40	40	50	490
min	max	440	420	420	410	420	420	420	420	440	430	420	420	5090
max	max	40	40	30	40	40	40	40	40	40	40	40	30	460

The combinations of factors are then indicated with lower case letters, where  $a$  represents combination of factors ( $A_{\max}$ ,  $B_{\min}$ ),  $b$  corresponds to ( $A_{\min}$ ,  $B_{\max}$ ), while the combination ( $A_{\max}$ ,  $B_{\max}$ ) is represented as  $ab$ . Furthermore, the situation ( $A_{\min}$ ,  $B_{\min}$ ) is illustrated as (1). The main effects of the factors and their combination are calculated using the formulas

$$A = \frac{ab + a - b - (1)}{2n} = \frac{460 + 490 - 5090 - 5580}{2 * 12} = -405,0$$

$$B = \frac{ab + b - a - (1)}{2n} = \frac{460 + 5090 - 490 - 5580}{2 * 12} = -21,7$$

$$AB = \frac{ab + (1) - a - b}{2n} = \frac{460 + 5580 - 490 - 5090}{2 * 12} = 19,2$$

Considering the signs of the effects, it can be concluded that increasing the values of the factors decreases the time needed to have the first symptoms of barotrauma, while their combination shows that the mutual influence of the parameters is significant. To calculate the variances of the factors it is first necessary to find the sums of squares, as presented below:

$$SS_A = \frac{(ab + a - b - (1))^2}{4n} = \frac{(460 + 490 - 5090 - 5580)^2}{4 * 12} = 1968300$$

$$SS_B = \frac{(ab + b - a - (1))^2}{4n} = \frac{(460 + 5090 - 490 - 5580)^2}{4 * 12} = 5633$$

$$SS_{AB} = \frac{(ab + (1) - a - b)^2}{4n} = \frac{(460 + 5580 - 490 - 5090)^2}{4 * 12} = 440$$

From these values it is possible to obtain the total sum of the squares and consecutively find the error, as presented below.

$$SS_T = \sum_{i=1}^2 \sum_{j=1}^2 \sum_{k=1}^n y_{ijk}^2 - \frac{y_{\Sigma}^2}{4n} = 1980592$$

$$SS_E = SS_T - SS_A - SS_B - SS_{AB} = 2250$$

Considering 8 degrees of freedom (DoF) of the experiment, it is possible to find average square, which allows to find the effect of the sources of variation and their combination, as presented in the next table and illustrated in the figure.

Table 8-5. Sensitivity analysis.

Source of variation	Sum of squares	DoF	Mean square	F <sub>0</sub>
A	1968300	1	1968300	874,8
B	5633	1	5633	2,5
AB	4408	1	4408	1,9
Errore	2250	8		
Totale	1980592	11		

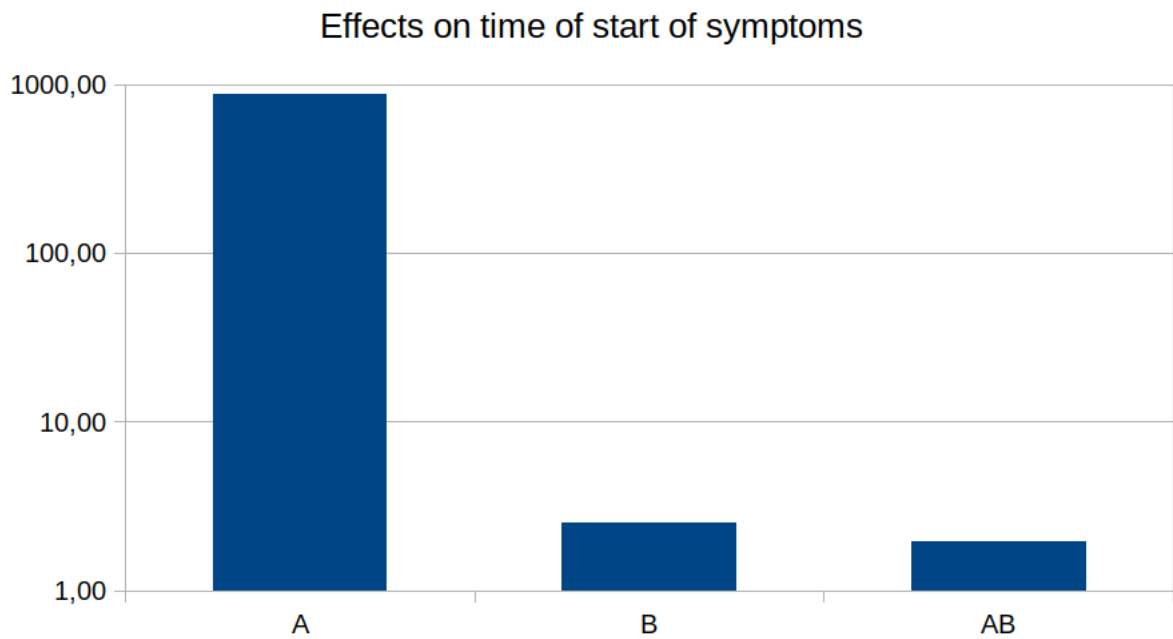


Figure 8-5. Effects on time of start of symptoms.

Furthermore, by performing more simulation runs it is possible to see that after about 25 tests the variance of the effects has stabilized, as shown in the figure.

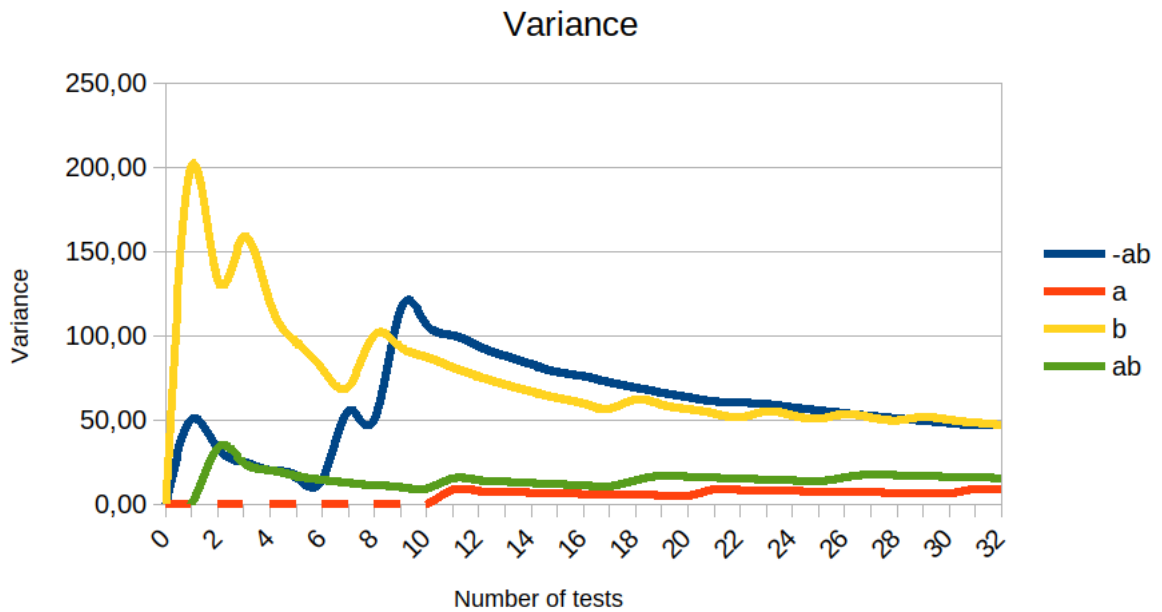


Figure 8-6. Variance stabilization in experimentation

## 8.6. Gas Flow Error Calculation

Considering that the research project is mainly focused on the gas and thermodynamic modelling, errors during gas flow calculations are evaluated. Considering that Riemann sum is used for integration, it is convenient to calculate differences between consecutive iterations, divided by their mean in order to obtain relative difference.

$$Err = \frac{F_k - F_{k-1}}{\frac{F_k + F_{k-1}}{2}} = 2 \frac{F_k - F_{k-1}}{F_k + F_{k-1}}$$

The error is calculated during pressurization of a virtual chamber, so the gas flow is almost constant, which corresponds to the vast majority of operations of the plant. Hence, different calculation time steps were applied in order to compare calculation results and check the relative error.

Table 8-6. Relative error between iterations of gas flow calculation.

Time step, ms	Relative error
10	0,00424%
100	0,0424%
1000	0,424%
10000	4,24%

In case of further increasing of the time step, the algorithm automatically introduces additional iteration steps, so the error could never exceed 10% during normal operation. Furthermore, low periodicity of recalculation of the plant's state would most certainly miss proper reaction to actions performed on the control panel, such as valve aperture for a second. In the same time, diminishing of the step would saturate computational capacity of the personal computer used for the simulation, causing possible missing calculation cycles (in case of calculation cycle overlap when duration of calculation exceeds interval between function calls) and blocking possibility to accelerate time when required. Similarly, error as function of number of iterations during integration at different time steps is analysed. From the figure it can be seen that system remains quite reliable even if the time step is increased up to 1 second.

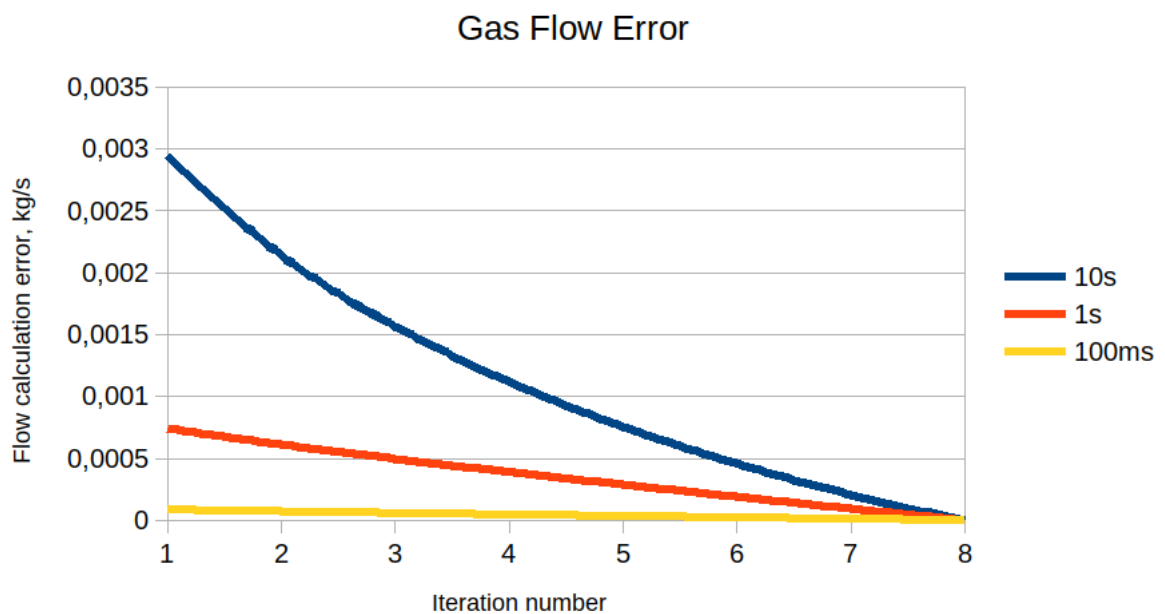


Figure 8-7. Gas flow calculation error

### 8.7. Experimentation with SME

One of fundamental steps during development of training systems is evaluation by experts in the field of interest. Indeed, in order to be suitable for training a simulator must provide not only realistic physics, but entire user experience with high attention to details and realism. For example, while accuracy of modelled physics could be evaluated by formulas, such aspect as realism of operation is subjective; hence, intervention of experts working to real-world solutions is fundamental.

In this research project, according to the formal requirements imposed by IMCA, operator's interface of the system must demonstrate "Real world" similarity to existing plants. Considering this, once Minimum Viable Product (MVP) is available, it must be tested with strict involvement of experts working in the field of saturation diving, especially active LSSs but also plant technicians and crew as well as specialists in underwater medicine. Apart from

validation of core functionality and fidelity of logic of behavior and model of physical processes, this approach allows to identify numerous secondary factors, which in their sum define overall realism. Considering this, experts were involved during all phases of development process. Indeed, following personnel was involved:

- Life Support Supervisors;
- Life Support Technicians;
- Underwater medicine expert;
- Technicians responsible for piping, electrical and electronic systems;

It is possible to identify following principal series of verification, validation and testing phases conducted with strict involvement of LSS and other experts:

- Identification of key components of the system. During this phase several plant visits and meeting with plant technicians and experts were performed. This phase is required to define system architecture and to verify conceptual model.
  - Testing: LSS and experts analyzed proposed architecture and logical flow of operation as well as define key aspects related to medical disorders. This step was performed iteratively multiple times and with different personnel in order to extend amount of useful information before development of plant's model.
  - Results: Conceptual model was created and approved by experts.
- Development of gas and thermodynamic models. Virtual Graphical User Interface (GUI) was created in order to support validation of gas and thermodynamic models. In this case, the LSS was able to utilize available controls (described in previous chapter) in order to perform some key operations as well as to estimate impact of divers on CO<sub>2</sub> concentration.
  - Testing: LSS and other saturation diving experts carry out compression and decompression of single chamber as well as atmosphere washing using virtual GUI. This step was performed iteratively several times with different experts and different scenarios in order to extend amount of useful information before development of mockup.
  - Results: Overall behavior is realistic, however, gas speed, hence, flow rate, in some pipelines was higher than expected. Furthermore, some modifications to calculation of humidity were found to be necessary. Model was adjusted to fine tune drag in pipes and other aspects of gas dynamics.
- Construction of equipment mock-up. Simplified replica of main control panel of the plant was created to support evaluation of different subsystems and their integration, the photo is presented below.
  - Testing: LSS carry out compression and decompression of single chamber as well as atmosphere washing using mockup of main control panel, which includes also additional control mechanisms and communication system. Expert in underwater medicine was involved in order to improve reaction of virtual divers to changes in environment.
  - Results: System behavior has some limitations: missing whistles during gas propagation in valves; limit value for triggering of some medical disorders must be modified; initial conditions and gas composition in gas cylinder packs must be adjusted; some secondary flow meters and pressure gauges must be added. Furthermore, some discrepancies between actual prototype plant and provided documentation were found. Simulator components were adjusted to address all these issues.



- Testing of completed system. During this phase a realistic control panel was constructed. During this phase LSS is expected to provide additional feedback in order to improve overall user experience by small adjustments.



*Figure 8-8. Testing control panel, atmospheric monitoring measurement equipment and communication system*

Hereafter are described steps of a typical experimentation session conducted on mock-up by an acting LSS:

1. Analysis of available equipment: check availability of required controls, verify presence of required analysers, testing of replicas of analysers to identify availability of specific functions.
2. Loading of simulation: control of initial conditions in different parts of virtual plant using analysers, check of pressure and gas compositions in gas cylinder packs, calibration of sensors.
3. Performing of one of common procedures, such as pressurisation: setting of back-pressure regulators, filling of manifolds, initial pressurisation of a selected chamber, leak check, control of variation of atmospheric parameters and comparison of actual and expected dynamic of internal atmosphere.
4. Secondary effects check: presence and intensity of whistles created by gas flow in valves, reaction to actions on air conditioning system, activation of shower.

Results of all actions as well as all comments of LSS were documented in order to provide required adjustments.

## 9. Conclusions

Operation of saturation diving facilities and corresponding life support supervision are very dangerous and require high levels of preparation and experience in different aspects of underwater activity. At the same time, current approach for training based on the use of empty real saturation diving plants has numerous drawbacks, such as necessity to keep idle such expensive system, difficulty to reproduce and to train on emergency situations as well as absence of feedback from divers inside the plant, which limits capability of trainee to identify potentially dangerous situations. Furthermore, in case of improper utilization, real expensive equipment could be damaged. Considering this, it was decided to develop models to address this problem, while this thesis focuses on the proposing a new simulation based solution capable to address all these issues.

Indeed, this research addresses the development of simulation based solution capable to achieve levels of training which are unattainable in case of traditional approach. The research benefits from collaboration with experts in different related fields, such as human behaviour modelling, operation of saturation diving plants, underwater medicine, gas and thermodynamic, human-machine interfaces, virtual reality, interoperable simulation, verification and validation techniques.

The analysis of a prototype plant conducted with involvement of different experts and specialized companies allowed to identify the key functionalities required from the simulator, set of equipment which is typically employed in the field, as well as numerous aspects related to plant operation. The analysis allowed to identify the requirements and the specific elements that need to be addressed in this new simulator devoted specifically to training, starting from main procedures and up to auxiliary operations such as object passing, usage of shower, replacement of gas scrubber and even evacuation. Based on this information and through strict collaboration with experts it was developed a gas and thermodynamic model of the new prototype plant; in addition, it was created a virtual user interface with function and configuration similar to the real plant that represents a digital twin of the hyperbaric chamber. Furthermore, it was conducted survey on currently used atmospheric analysers and sensors, their principal and auxiliary functions, regular behaviour and regulations related to their utilization. Finally, the collaboration with experts conducted during training courses allowed to properly tune the development of a specific control panel for trainer, which allows to load predefined scenarios, save state of the system in order to replay same moment, act on divers and parts of the plant creating even emergency situations, such as gas leakages and fire. Based on requirements it was developed and extensible control logic, which allows to easily introduce new entities and actions in the scenario.

The thesis includes also a state of the art on this sector and related researches; from this study it emerged that nowadays most of the courses on these specific plants are conducted on empty real plants during their down for maintenance while on the market there are just a limited number of virtual simulators, usually which shortfalls respect the aspects dealing with the models related to the divers and human physiology. In facts, these results confirmed the importance of the proposed subject and the opportunity to develop specific models for this kind of plants. At the same time, the research on human-machine interactions allowed to identify the different possible portable user interfaces which could be used when replica of real control system are not available or not required. For instance, in case of demonstration or education purposes, during introductive courses or in exhibitions, this approach makes much more convenient and inexpensive the use of the virtual simulator.

In fact, it was completed an analysis of human behaviour models revealed main factors to take into consideration during emergencies; this approach led to the creation of dedicated Intelligent Agents suitable for that purpose.

Then proposed simulator include also physiological and medical elements, indeed an analysis of principal health disorders allowed to identify several main illnesses, their main symptoms, environmental conditions when they occur and to develop an algorithm, capable to trigger different reactions of virtual divers as response to the conditions, considering not only instant conditions but also time of exposure and individual characteristics of simulated entities. Finally, the involvement of SMEs (Small Medium Size Enterprises) active in the sector allowed to tune the models and to setup proper and realistic values of levels triggering these symptoms. This approach allowed to introduce missing human physiology in training process of LSS, hence, to improve quality of training and in the future safety of divers. In order, to facilitate parameter tuning, it was developed an universal data structure suitable for representation of different diseases and their characteristics, capable to be extended by modifying existing illnesses or by introduction of new ones. Apart from other advantages, this functionalities and presence of virtual humans makes trainee to pay more attention to actions performed on the control panel. Research on different interoperability mechanisms lead to identification of possible system architectures with their strengths and limitations, taking into account such factors as synchronization of execution, fast and reliable data exchange, possibility to connect computers with different types of hardware and running distinct operation systems, possibility to introduce control mechanisms for execution flow, available to the instructor and essential for training process. This study revealed necessity to employ ad hoc solution with functionality inspired partially by High Level Architecture.

Obviously it was necessary to apply VV&A (Verification, Validation and Accreditation) techniques and to define the tests which need to be applied to the system in order to support correct and effective development. In particular, numerous tests were conducted by the author using indications provided by experts; for instance, data on pressure variation in time in real plant in certain conditions, which then was compared to the behaviour of the gas model included in the simulator. Similar tests were conducted with respect to gas concentrations, partial pressures, variations of temperature and humidity. Thanks to this approach, gas model was confirmed to be sufficiently effective and precise since the first phases of the project, while SMEs were able to consequently validate and fine tune mostly completed solution.

All these activities allowed to create a simulator prototype, capable to address not only gas dynamics and tasks performed nowadays during training, but many other aspects, such as modelling of human physiology, auxiliary procedures performed during operation of facilities and even emergency situations. The proposed innovative solution is essential for improvement of quality of preparation of Life Support Supervisors, hence increase safety of operation of saturation diving facilities in both normal and emergency conditions. At the same time, developed methodologies are applicable to other fields and situations and were already reutilized in various research projects. Work on the project was accompanied by participation of several conferences and publication of articles as co-author in proceedings and journal, which are used during preparation of this report and used as references. In particular, results were presented by the author in I3M 2017, I3M 2018, SummerSim 2019, I3M2019 and I3M2020 conferences, while study on utilization of autonomous system was published in International Journal of Simulation and Process Modelling. In all articles the author is present as co-author and is responsible for parts related to development and implementation. All publications with involvement of the author are listed in corresponding section and are cited in text.

## 10. References

- Ahlén, C., Iversen, O. J., Risberg, J., Volden, G., & Aarset, H. (1998). Diver's hand: a skin disorder common in occupational saturation diving. *Occupational and environmental medicine*, 55(2), 141-143.
- Airbus, S. A. S. (2005). Aircraft characteristics, airport and maintenance planning. *Customer Services Technical Data Support and Services*, 31707, Blagnac Cedex, FRANCE.
- Androulaki, E., A. Barger, V. Bortnikov, C. Cachin, K. Christidis, A. De Caro, D. C. Enyeart, Ferris, G. Laventman, Y. Manevich, S. Muralidharan, C. Murthy, N. Nguyen, M. Sethi, G. Singh, K. Smith, A. Sorniotti, C. Stathakopoulou, M. Vukolić, S. Weed Cocco & J. Yellick (2018). Hyperledger Fabric: A Distributed Operating System for Permissioned Blockchains. In *Proceedings of EuroSys '18: Thirteenth EuroSys Conference*. New York, NY, USA, ACM. Available via <https://doi.org/10.1145/3190508.3190538>. Accessed Feb. 19, 2019.
- ANSI (1993). IEEE std 1278-1993. Standard for information technology, Protocols for distributed interactive simulation.
- Avial-Chicharro, L. (2019). Romans prized these jewels more than diamonds. *National Geographic*, 2, 03-04.
- Baillie, K. & Simpson, A. (2007). "Acute mountain sickness". *Apex Altitude Physiology Expeditions*. Retrieved 2007-08-08: vol 4: 231\_233.
- Balci, O. (1997). Verification validation and accreditation of simulation models. In *Proceedings of the 29th conference on Winter simulation* (pp. 135-141).
- Barreiros, P., Haddad Jr, V. & Barreiros, J. P. (2017). Description of an eye barotrauma in scuba diving with clinical discussion. *Journal of Coastal Life Medicine*.
- Becker, G. D., & Parell, G. J. (2001). Barotrauma of the ears and sinuses after scuba diving. *European archives of oto-rhino-laryngology*, 258(4), 159-163.
- Bevan, J. (2005). *The Professional Divers's Handbook* (second ed.). 5 Nepean Close, Alverstoke, GOSPORT, Hampshire PO12 2BH: Submex Ltd.
- Bissett, T., & Viau, G. (2003). Atmospheric diving as an alternative technology for platform inspections. Ocean Works International Inc.
- Bitterman, H. (2009). Bench-to-bedside review: oxygen as a drug. *Critical Care*, 13(1), 205.
- BLS (2020). Occupational Employment and Wages: 49-9092 Commercial Divers. . Washington DC: U.S. Department of Labor, Bureau of labor Statistics, <https://www.bls.gov/oes/current/oes499092.htm>
- BLS (2019a). Number of nonfatal occupational injuries and illnesses involving days away from work by selected worker and case characteristics and occupation, commercial divers. Washington DC: U.S. Department of Labor, Bureau of Labor Statistics, [https://www.bls.gov/iif/oshwc/osh/case/cd\\_r44\\_2017.htm](https://www.bls.gov/iif/oshwc/osh/case/cd_r44_2017.htm)
- BLS (2019b). Fatal occupational injuries by occupation and event or exposure, all United States, 2017. Washington DC: U.S. Department of Labor, Bureau of Labor Statistics, <https://www.bls.gov/iif/oshwc/cfoi/cftb0317.htm>
- BLS (2019c). Number of nonfatal occupational injuries and illnesses involving days away from work by occupation and number of days away from work, and median

number of days away from work, private industry, 2017. Washington DC: U.S. Department of Labor, Bureau of Labor Statistics, [https://www.bls.gov/iif/oshwc/osh/case/cd\\_r66\\_2017.htm](https://www.bls.gov/iif/oshwc/osh/case/cd_r66_2017.htm)

- Broekhuijsen, N. (2020) Folding@Home Now More Powerful Than Top 500 Supercomputers ombined. Tom's Hardware.
- Bruzzone, A.G., Sinelshchikov, K., Gotelli, M. & Fabbrini, G. (2020a). Town Protection Simulation. 19th International Conference on Modeling and Applied Simulation, MAS 2020, Held at the International Multidisciplinary Modeling and Simulation Multiconference, I3M 2020
- Bruzzone, A.G., Sinelshchikov, K. & Massei, M. (2020b). Epidemic Simulation based on Intelligent Agents. 9th International Workshop on Innovative Simulation for Health Care, IWISH 2020, Held at the International Multidisciplinary Modeling and Simulation Multiconference, I3M 2020
- Bruzzone, A. G., Massei, M., & Sinelshchikov, K. (2019a). Application of blockchain in interoperable simulation for strategic decision making. In Proceedings of the 2019 Summer Simulation Conference (pp. 1-10).
- Bruzzone, A.G., Cianci, R., Sciomachen, A., Sinelshchikov, K. & Agresta, M. (2019b). A digital twin approach to develop a new autonomous system able to operate in high temperature environments within industrial plants. International Summer Computer Simulation Conference, Summersim, SCS, Berlin, Germany, July 22-24
- Bruzzone, A.G., Agresta, M., Sinelshchikov, K. & Massei, M. (2019c). Intelligent autonomous system devoted to improve efficiency and safety in industrial plants. 31th European Modeling and Simulation Symposium, EMSS 2019, Held at the International Multidisciplinary Modeling and Simulation Multiconference, I3M 2019
- Bruzzone, A.G., Massei, M., Sinelshchikov, K., Fadda, P., Fancello, G., Fabbrini, G. & Gotelli, M. (2019d). Extended reality, intelligent agents and simulation to improve efficiency, safety and security in harbors and port plants. 21th International Conference on Harbor, Maritime and Multimodal Logistics Modeling and Simulation, HMS 2019, Held at the International Multidisciplinary Modeling and Simulation Multiconference, I3M 2019
- Bruzzone, A.G., Massei, M., Sinelshchikov, K., Longo, F., Agresta, M., Di Donato, L. & Di Francesco, C. (2019e). Wearable mixed reality solutions for industrial plants and production lines. 18th International Conference on Modeling and Applied Simulation, MAS 2019, Held at the International Multidisciplinary Modeling and Simulation Multiconference, I3M 2019
- Bruzzone, A.G., Massei, M., Longo, F., Di Matteo, R. & Sinelshchikov, K. (2018a). Learning decision making processes at strategic level based on VR & augmented reality. Workshop on Applied Modelling and Simulation, WAMS, Praha, Czech Republic, October 17-19 2018
- Bruzzone, A.G., Sinelshchikov, K. & Di Matteo, R. (2018b). Population Behavior, Social Networks, Transportations, infrastructures & Urban Simulation for Decision Makers. 30th European Modeling and Simulation Symposium, EMSS 2018, Held at the International Multidisciplinary Modeling and Simulation Multiconference, I3M 2018
- Bruzzone, A.G., Agresta, M. & Sinelshchikov, K. (2017a). Simulation as Decision Support System for Disaster Prevention. In Proceedings of SESDE, edited by G.

Zacharewicz, A. Bruzzone, J.S. Janosy, L. Nicoletti, pp. 36–43. Rende, Italy, CAL-TEK S.r.l.

- Bruzzone, A.G., Massei, M., Agresta, M., Di Matteo, R., Sinelshchikov, K., Longo, F., Nicoletti, L., Di Donato, L., Tomassini, L., Console, C., Ferraro, A., Pirozzi, M., Puri, D., Vita, L., Cassandra, F., Mennuti, C., Augugliaro, G., Site, C.D., Di Palo, F. & Bragatto, P. (2017b). Autonomous systems & safety issues: The roadmap to enable new advances in industrial applications. 29th European Modeling and Simulation Symposium, EMSS 2017, Held at the International Multidisciplinary Modeling and Simulation Multiconference, I3M 2017, Pages 565-571
- Bruzzone, A.G., Massei, M., Nicoletti, L., Sinelshchikov, K., Di Matteo, R., Cardelli, M. & Kandunuri, P.K. (2017c). Immersive, interoperable and intuitive mixed reality for service in industrial plants. 16th International Conference on Modeling and Applied Simulation, MAS 2017, Held at the International Multidisciplinary Modeling and Simulation Multiconference, I3M 2017, Pages 208-213
- Bruzzone, A.G., Di Matteo, R., Massei, M., Russo, E., Cantilli, M., Sinelshchikov, K. & Maglione, G.L. (2017d). Interoperable simulation and serious games for creating an open cyber range. 7th International Defense and Homeland Security Simulation Workshop, DHSS 2017, Held at the International Multidisciplinary Modeling and Simulation Multiconference, I3M 2017, Pages 90-97
- Bruzzone, A.G., Massei, M., Maglione, G.L., Sinelshchikov, K. & Di Matteo, R. (2017e). A strategic serious game addressing system of systems engineering. 16th International Conference on Modeling and Applied Simulation, MAS 2017, Held at the International Multidisciplinary Modeling and Simulation Multiconference, I3M 2017 pp. 214-219
- Bruzzone, A.G., Agresta, M. & Sinelshchikov, K. (2017f). Hyperbaric plant simulation for industrial applications. 6th International Workshop on Innovative Simulation for Health Care, IWISH 2017, Held at the International Multidisciplinary Modeling and Simulation Multiconference, I3M 2017 pp. 80-86
- Bruzzone, A.G., Massei, M., Agresta, M., Sinelshchikov, K. & Di Matteo, R. (2017g). Agile solutions & data analytics for logistics providers based on simulation. 19th International Conference on Harbor, Maritime and Multimodal Logistics Modeling and Simulation, HMS 2017, Held at the International Multidisciplinary Modeling and Simulation Multiconference, I3M 2017 pp. 164-171
- Bruzzone, A. G., Massei, M., Poggi, S., Bartolucci, C., & Ferrando, A. (2015). Intelligent agents for human behavior modeling as support to operations. In *Simulation and Modeling Methodologies, Technologies and Applications* (pp. 119-132). Springer, Cham.
- Bruzzone A.G., M. Massei, M. Agresta, S. Poggi & F. M. Camponeschi (2014). Addressing strategic challenges on mega cities through MS2G. In *Proceedings of MAS2014*, edited by A.G. Bruzzone, M. Massei, F. De Felice, Y. Merkuriev, A. Solis, G. Zacharewicz, pp. 231–240. Genova, Italy, Dime University of Genoa.
- Bruzzone, A. G. (2013). Intelligent agent-based simulation for supporting operational planning in country reconstruction. *International Journal of Simulation and Process Modelling*, 8(2-3), 145-159.
- Bruzzone, A. G., Frascio, M., Longo, F., Massei, M., Siri, A., & Tremori, A. (2012). MARIA: An agent driven simulation for a web based serious game devoted to renew education processes in health care. In *Proceedings of the International Workshop on Innovative Simulation for Health Care* (pp. 188-194). Rende, Italy: CAL-TEK S.r.l.

- Buss, A., & Jackson, L. (1998). Distributed simulation modeling: a comparison of HLA, CORBA, and RMI. In *1998 Winter Simulation Conference. Proceedings (Cat. No. 98CH36274)* (Vol. 1, pp. 819-825). IEEE.
- Charles, B. (1898). *Submarine Telegraphs: Their History, Construction, and Working*. Crosby Lockwood and Son, 679.
- CKAS Mechatronics Diving Supervision Simulator. Retrieved from [http://www.ckas.com.au/diving\\_supervisor\\_sims\\_55.html](http://www.ckas.com.au/diving_supervisor_sims_55.html)
- Cousteau, J. Y., & Dumas, F. (1953). *The silent world*. New York and London.
- Czupalla, M. (2011). *The Virtual Habitat – Integral Modeling and Dynamic Simulation of Life Support Systems.*, Ph.D. Thesis Technische Universität München, Verlag Dr. Hut, 2011
- Czupalla, M., Horneck, G. & Blome, H.J. (2005). The conceptual design of a hybrid life support system based on the evaluation and comparisons of terrestrial testbeds. *Adv. Space Res.* Vol. 35, pp. 1609-1620, 2005
- Davis, R. H. (1934). DEEP DIVING AND UNDER-WATER RESCUE: II. *Journal of the Royal Society of Arts*, 82(4267), 1049-1065.
- Davis, M. (1979). Immersion hypothermia in scuba diving.
- Davis, P. J., & Rabinowitz, P. (2007). *Methods of numerical integration*. Courier Corporation.
- de Ruyter, W., Pellegrino, S., & Cariou, H. (2005). The Sanha LPG FPSO. In *Offshore Technology Conference*. Offshore Technology Conference.
- Diem, J., Henninger, A. & Youngblood, S. (2010). VV&A of M&S in the DoD: Moving from Art to Science. *ITEA Journal*, 31: 324-327.
- Disparte, D.A. (2019). Why Enterprise Blockchain Projects Fail. *Forbes*
- DoD, USA Department of Defense (2009). Instruction 5000.61 “DoD Modeling and Simulation (M&S) Verification, Validation and Accreditation (VV&A).
- Edmonds, C. (1971). *Vertigo In Diving*. Royal Australian Navy.
- Emmerman, M. N. (1988). Commercial aircraft cabin differential pressure settings and actual cabin altitudes during flights.
- Evan J. (2005). *The Professional Diver's Handbook*. Gosport, UK: Submex Ltd.
- Feng, X., Shen, J., & Fan, Y. (2009). REST: An alternative to RPC for Web services architecture. In *2009 First International Conference on Future Information Networks* (pp. 7-10). IEEE.
- Ferguson, N., Schneier, B., & Kohno, T. (2010). *Cryptography engineering: Design Principles and Practical Applications*
- Fette, I., & Melnikov, A. (2011). The websocket protocol.
- Fida, B., Cutolo, F., di Franco, G., Ferrari, M., & Ferrari, V. (2018). Augmented reality in open surgery. *Updates in surgery*, 70(3), 389-400.
- Fisher D. L., Rizzo M., Caird J., & Lee J. D. (2011). *Handbook of driving simulation for engineering, medicine, and psychology*. Boca Raton, USA: CRC Press
- Frascio, M., Cortese, K., Longo, F. & Sinelshchikov, K. (2019). Multidisciplinary development of a simulation of industrial plant disasters designed for improving safety through training and new procedures. *International Journal of Simulation and Process Modelling*
- Gaba, D. M. (2004). The future vision of simulation in health care. *Quality and safety in Health care*, Volume 13, Issue suppl 1 , 2004

- Gamma, E., Helm, R., Johnson, R. & Vlissides, J. (1994). Design Patterns: elements of reusable object-oriented software. Addison-Wesley.
- Gardette, B., Massimelli, J., Comet, M., Gortan, C., Delauze, H., Comex, S., & France, M. (1993). Hydra 10: a 701 msw onshore record dive using “Hydreliox.” In *XIXth annual meeting of European undersea biomedical society on diving and hyperbaric medicine. Trondheim: SINTEF UNIMED.*
- Garg, A., Waters, T., Kapellusch, J., & Karwowski, W. (2014). Psychophysical basis for maximum pushing and pulling forces: A review and recommendations. *International journal of industrial ergonomics*, 44(2), 281-291.
- General Accounting Office of USA (1979). Guidelines for model evaluation. Retrieved from: <https://www.gao.gov/assets/130/125477.pdf>
- Giertsen, J. C., Sandstad, E., Morild, I., Bang, G., Bjersand, A. J., & Eidsvik, S. (1988). An explosive decompression accident. *The American Journal of Forensic Medicine and Pathology*, 9(2), 94-101.
- Ginters, E., Burkhardt, D., Nazemi, K. & Merkuryev, Y. (2019). The concept of augmented reality application for putting alignment in golf. In proceedings of 5th International Conference of the Virtual and Augmented Reality in Education, VARE 2019, Lisbon, Portugal.
- Glover, B. (2005). History of the Atlantic Cable & Submarine Telegraphy.
- Goldberg, D. (1991). What every computer scientist should know about floating-point arithmetic. *ACM Computing Surveys (CSUR)*, 23(1), 5-48.
- Goldsman, D., Nance, R. E., & Wilson, J. R. (2010). A brief history of simulation revisited. In *Proceedings of the 2010 Winter Simulation Conference* (pp. 567-574). IEEE.
- Goldstine, H. H., & Goldstine, A. (1946). The electronic numerical integrator and computer (eniac). *Mathematical Tables and Other Aids to Computation*, 2(15), 97-110.
- Granowetter, L. (2003). RTI interoperability issues—API standards, wire standards, and RTI bridges. In *Proceedings of the 2003 European Simulation Interoperability Workshop* (No. 03S-SIW, p. 063).
- Grunwald, G. (2016). Medusa: Gauges for JavaFX. Retrieved from: <https://community.oracle.com/docs/DOC-992746>
- Hand, E. (2010). People power: networks of human minds are taking citizen science to a new level. *Nature*, 466(7307), 685-688.; Anderson, D. P. (2004). Boinc: A system for public-resource computing and storage. In *Fifth IEEE/ACM international workshop on grid computing* (pp. 4-10). IEEE.
- Harrison, G. (2015). Next Generation Databases: NoSQLand Big Data. NYC, Apress.
- Heyward, V (1998). "Advance Fitness Assessment & Exercise Prescription, 3rd Ed". p. 48.
- Hills, A. P., Mokhtar, N., & Byrne, N. M. (2014). Assessment of physical activity and energy expenditure: an overview of objective measures. *Frontiers in nutrition*, 1, 5.
- Hughes-Hallett, D., Lock, P. F., Gleason, A. M., Flath, D. E., Gordon, S. P., Lomen, D. O., & Tecosky-Feldman, J. (2017). *Applied calculus*. John Wiley & Sons.
- International Cable Protection Committee. (2011). About Submarine Power Cables



- International Marine Contractors Association (IMCA) (2020a). Guidance on the use of simulators.
- International Marine Contractors Association (IMCA) (2020b). IMCA Diving Certification Schemes; retrieved from: <https://www.imca-int.com/divisions/diving/personnel/imca-certification/>
- Imbert, J. P., Balestra, C., Kiboub, F. Z., Loennechen, Ø., & Eftedal, I. (2019). Commercial divers' subjective evaluation of saturation. *Frontiers in Psychology*, 9, 2774.
- IMCA Safety Flash 20/19 (2019).
- IMO (International Maritime Organization) (1985). Amendments to the Code of Safety for Diving Systems (Resolution A.536(13)).
- Jones, H. (2003). Design Rules for Space Life Support Systems. NASA Ames Research Center.
- Karagiannis, V., Chatzimisios, P., Vazquez-Gallego, F., & Alonso-Zarate, J. (2015). A survey on application layer protocols for the internet of things. *Transaction on IoT and Cloud computing*, 3(1), 11-17.
- Karneyeu, A. E., Segal, B., Skands, P., & Grey, F. (2012). LHC@Home: a volunteer computing system for massive numerical simulations of beam dynamics and high energy physics events. In 3rd International Particle Accelerator Conference 2012, IPAC 2012 (pp. 505-507).
- Keith, D. H., & Frey, D. A. (1979). Saturation diving in nautical archaeology. *Archaeology*, 32(4), 24-33.
- Kress, B. C. (2019). Digital optical elements and technologies (EDO19): applications to AR/VR/MR. In *Digital Optical Technologies 2019* (Vol. 11062, p. 1106222). International Society for Optics and Photonics.
- Lee, D., Park, J. H., & Kim, H. (2004). A study on experiment of human behavior for evacuation simulation. *Ocean Engineering*, 31(8-9), 931-941.
- Lillo, R. S., & Caldwell, J. M. (2005). *Laboratory Evaluation of the Analox Sub MK II PS Prototype Hyperbaric O2CO2 Analyzer*. NAVY EXPERIMENTAL DIVING UNIT PANAMA CITY FL.
- Limbrick, J. (2002). *North Sea Divers: A requiem*. Authors On Line Ltd.
- Loer, S.A., Scheeren, T.W. & Tarnow, J. (1997). How much oxygen does the human lung consume? *Anesthesiologist*; 86:532–537.
- Love, R. (2005). Get on the D-BUS. *Linux Journal*, 2005(130), 3.
- Lundgren, C. E. (1965). Alternobaric vertigo—a diving hazard. *British medical journal*, 2(5460), 511.
- Maeda, K. (2012). Performance evaluation of object serialization libraries in XML, JSON and binary formats. In *2012 Second International Conference on Digital Information and Communication Technology and its Applications (DICTAP)* (pp. 177-182). IEEE.
- Mahler, P. (2005). *VoIP Telephony with Asterisk*. Signate.
- Mangler, J., Schikuta, E. & Witzany, C. (2009). Quo vadis interface definition languages? Towards a interface definition language for RESTful services. In 2009 IEEE International Conference on Service-Oriented Computing and Applications (SOCA) (pp. 1-4). IEEE.
- Matsen, B. (2009). *Jacques Cousteau: the sea king*. New York: Pantheon; p. 320.

- Matsuo, T., So, R., & Takahashi, M. (2020). Workers' physical activity data contribute to estimating maximal oxygen consumption: a questionnaire study to concurrently assess workers' sedentary behavior and cardiorespiratory fitness. *BMC public health*, 20(1), 22.
- Mayol, D. (1996). The Swedish ship Vasa's revival. Miami, Florida: University of Miami, Anthropology 30s–Marine Archaeology.
- McGovern, P. E., & Michel, R. H. (1985). Royal Purple dye: tracing the chemical origins of the industry. *Analytical Chemistry*, 57(14), 1514A-1522A., Deidun, A. (2012). Historic industries in Maltese waters.
- McQuay, W. K. (1997). The new vision for modeling and simulation in the DoD acquisition process. In 16th DASC. AIAA/IEEE Digital Avionics Systems Conference. Reflections to the Future. Proceedings (Vol. 1, pp. 0-2). IEEE.
- Merkuryeva, G., Merkuryev, Y., Sokolov, B. V., Potryasaev, S., Zelentsov, V. A., & Lektavers, A. (2015). Advanced river flood monitoring, modelling and forecasting. *Journal of computational science*, 10, 77-85.
- Mohiddin, R., Kumar, M., Palakurty, S. K., Bothra, S., Srinivas, M. B., Pidugu, N. & Kane, P. (2011). Building a sensor network with PSoC. In Proceedings of Fifth International Conference on Sensing Technology (pp. 353-357). IEEE.
- Möller, B., Antelius, F., & Karlsson, M. Towards a Standardized Federate Protocol for HLA 4. In proceedings of Winter Simulation Interoperability Workshop.
- Möller, B., & Olsson, L. (2004). Practical experiences from HLA 1.3 to HLA IEEE 1516 Interoperability. 04f-siw-045, www. sisostds. Org.
- Möller, B., Garro, A., Falcone, A., Crues, E. Z., & Dexter, D. E. (2017). On the execution control of HLA federations using the SISO space reference FOM. In 2017 IEEE/ACM 21st International Symposium on Distributed Simulation and Real Time Applications (DS-RT) (pp. 1-8). IEEE.
- Montgomery, D. C. (2017). *Design and analysis of experiments*. John Wiley & sons.
- Mueller, B., Crues, E. Z., Dexter, D., Garro, A., Skuratovskiy, A., & Vankov, A. (2016). A First Look at the Upcoming SISO Space Reference FOM.
- Muller, J. M., Brisebarre, N., De Dinechin, F., Jeannerod, C. P., Lefevre, V., Melquiond, G. & Torres, S. (2018). Handbook of floating-point arithmetic (Vol. 1). Birkhäuser.
- Nakamoto, S. (2008). Bitcoin: A peer-to-peer electronic cash system. <https://bitcoin.org/bitcoin.pdf>. Accessed Feb. 19, 2019.
- NAVSEA. Technical manual for nuclear powered submarine atmosphere control manual. 2013
- Nemeth, E., Snyder, G., Hein, T. R., Whaley, B. & Mackin, D. (2017). UNIX and Linux system administration handbook. 5th edition. Addison-Wesley Professional.
- Nuckols, M. L., Purer, A. & Deason, G.A. (1985). Technical Manual: Design Guidelines for Carbon Dioxide Scrubbers. *Naval Coastal Systems Center*, 4110, 1-83.
- Ovidi, F., Zhang, L., Landucci, G., & Reniers, G. (2021). Agent-based model and simulation of mitigated domino scenarios in chemical tank farms. *Reliability Engineering & System Safety*, 209, 107476.
- Ozel, F. (1992). Simulation modeling of human behavior in buildings. *Simulation*, 58(6), 377-384.
- Pale Blue dive control simulator. Retrieved from: <https://pale.blue/simulators/sub-sea-and-diving/dive-control-simulator/>

- Pautasso C., Zimmermann O. & Leymann F. (2008). Restful Web Services vs. "Big" Web Services: Making the Right Architectural Decision. In 17th International World Wide Web Conference, pages 805–814, New York, NY. ACM Press.
- Petri, N. M. (2003). Change in strategy of solving psychological tests: evidence of nitrogen narcosis in shallow air-diving. *Undersea Hyperb Med*, 30(4), 293-303.
- Prosser, J., & Grey, H. V. (1990). *Cave diving communications*. Cave Diving Section of the National Speleological Society.
- Rakowski, K. (2015). Learning Apache Thrift. Packt Publishing Ltd.
- Recreational Scuba Training Council (RSTC, 2005). Minimum Course Content for Common Hand Signals for Scuba Diving.
- Sargent, R. G., & Balci, O. (2017). History of verification and validation of simulation models. In *2017 Winter Simulation Conference (WSC)* (pp. 292-307). IEEE.
- Sayer, M. D., & Azzopardi, E. (2014). The silent witness: using dive computer records in diving fatality investigations. *Diving Hyperb Med*, 44, 167-9.
- Schrank, W. E., & Holt, C. C. (1967). Critique of: "Verification of Computer Simulation Models". *Management Science*, 14(2), B-104.
- Scotland FAI (Fatal Accident Inquiry). (1977) March 30-31.
- SISO [www.sisostds.org](http://www.sisostds.org)
- Smerz, R. W. (2004). Incidence of oxygen toxicity during the treatment of dysbarism. *Undersea Hyperb Med*, 31(2), 199-202.
- Smithuis, J. W., Gips, E., van Rees Vellinga, T. P., & Gaakeer, M. I. (2016). Diving accidents: a cohort study from the Netherlands. *International journal of emergency medicine*, 9(1), 1-7.
- Sousa, A., Figueiredo, P., Pendergast, D., Kjendlie, P. L., Vilas-Boas, J. P., & Fernandes, R. J. (2014). Critical evaluation of oxygen-uptake assessment in swimming. *International journal of sports physiology and performance*, 9(2), 190-202.
- Sousa, J., Bessani, A. & Vukolic, M. (2018). A byzantine fault-tolerant ordering service for the hyperledger fabric blockchain platform. In Proceedings of 48th Annual IEEE/IFIP International Conference on Dependable Systems and Networks (DSN), pp. 51-58. IEEE.
- Spiegel, J. (2000). CORBA 3 fundamentals and programming (Vol. 2). New York, NY, USA:: John Wiley & Sons.
- Tetzloff, K., Bettinghausen, E., Renter, M., Heller, M., & Leplow, B. (1997). Risk factors for pulmonary barotrauma in divers. *Chest*, 112(3), 654-659.
- Tong, Z., Li, P., Yang, L., & Wang, H. (2020). Agent-based simulation for a regional guarantee circle crisis. *Journal of Simulation*, 1-17.
- United States Department of the Navy. (2016). US Navy Diving Manual. Retrieved from [http://www.navsea.navy.mil/Portals/103/Documents/SUPSALV/Div-ing/US%20DIVING%20MANUAL\\_REV7.pdf?ver=2017-01-11-102354-393](http://www.navsea.navy.mil/Portals/103/Documents/SUPSALV/Div-ing/US%20DIVING%20MANUAL_REV7.pdf?ver=2017-01-11-102354-393).
- Van Horn, R. L. (1971). Validation of simulation results. *Management Science*, 17(5), 247-258.
- Van Steen, M. (2010). Graph theory and complex networks. *An introduction*, 144.
- Van Steen, M. & Tanenbaum, A. S. (2007). *Distributed systems: principles and paradigms*. Prentice-Hall.
- Vermesan, A. I. (1998). Software certification for industry-verification and validation issues in expert systems. In *Proceedings Ninth International Workshop on Database and Expert Systems Applications (Cat. No. 98EX130)* (pp. 3-14). IEEE.

- Yassin, M. A., & Soliman, D. S. (2017). Congenital Methemoglobinemia Under Diagnosed Condition with Variable Therapeutic Options. *Blood*, 130(Supplement 1), 4746-4746.
- Yilmaz, L., Ören, T., & Aghae, N. G. (2006). Intelligent agents, simulation, and gaming. *Simulation & Gaming*, 37(3), 339-349
- Zhukov, A., Czupalla, M. & Stuffer, T. (2010). Correlation of the ISS Life Support System Simulation with ANITA data. SAE Technical Paper. 2010-01-0205, 2010
- Zimmerman, M. I., Porter, J. R., Ward, M. D., Singh, S., Vithani, N., Meller, A. & Hurley, M. F. (2020). Citizen scientists create an exascale computer to combat COVID-19. *BioRxiv*.