

**UNIVERSITA' DEGLI STUDI DI CATANIA**

**DOTTORATO DI RICERCA INTERNAZIONALE IN INGEGNERIA AGRARIA**

**CICLO XXV**

---

**PhD Thesis**

**Dr Andrea Restuccia**

**Renewable energy in Sicily: sizing of a plant for Biogas  
production and energetic assessment of Biodiesel  
production from oilseed crops**

*Tutor: Dr Sabina Failla*

*Coordinator: Prof. Simona Consoli*

---

**Academic Years 2009-2013**



# TABLE OF CONTENT

<i>Preface</i> .....	1
<i>Aim of the thesis</i> .....	4
Chapter 1: Focus on renewable energy: Biogas and Biodiesel .....	6
1. The renewable energy in Italy and in the world .....	7
1.1. The context.....	7
1.2. Statistical data .....	8
2. The Biofuels.....	9
2.1 The Biogas .....	12
2.1.1 The biological process .....	13
2.1.2 Usable biomass .....	16
2.1.3 Plant typologies .....	18
2.1.4 Biogas quality and its use.....	20
2.2 The Biodiesel .....	22
2.2.1 The Biological process.....	23
2.2.2 Vegetable oil for biodiesel production .....	25
2.2.3 Biodiesel production chain.....	26
2.2.4 International standards.....	27
Chapter 2: Stages abroad .....	29
1. The American Experience .....	30
1.1 Aim of the stage .....	30
1.2 The IBR biogas plant.....	31
1.3 The experimental activities.....	33
2. The Irish Experience .....	36

2.1	Aim of the stage .....	36
2.2	The UASB reactor .....	36
2.3	The experimental activities .....	38
Chapter 3:	Experimental Results.....	39
Section I:	The Biogas .....	40
	“Location and sizing of an anaerobic digestion plant for biogas production in south-eastern Sicily” .....	40
1.	Introduction.....	41
2.	Methodology .....	42
2.1	The area surveyed.....	42
2.2	Detecting of farms and biomass availability .....	43
2.3	Biogas plant location .....	46
3.	Results and discussions .....	48
3.1	Productivity of biomass energy and sizing of CHP unit.....	48
3.2	Profitability of the plant.....	51
4.	Conclusions.....	53
Section II:	The biodiesel.....	55
	“Biodiesel production from unconventional oil bearing crops” .....	55
1.	Introduction.....	56
2.	Cultivated Species .....	58
2.1.	<i>Linum usitatissimum</i> L. ....	58
2.2.	<i>Camelina sativa</i> L. ....	59
3.	Material e methods .....	61
3.1.	Experimental field .....	61
3.1.1.	The cultural practices and the machines .....	61

3.1.2.	The methodology of field tests.....	65
3.2.	Oil Extraction.....	66
3.2.1.	Methodology of mechanical extraction of oil.....	67
3.3.	Transesterification for biodiesel production.....	71
3.3.1.	Methodology of transesterification of vegetable oil.....	72
3.4.	Process flow chart: screw pressing and trans-esterification.....	77
3.5.	Energy Return On Energy Invested .....	78
4.	Results and discussions .....	81
4.1.	Mechanization and agronomic results.....	81
4.2.	Oil extraction results .....	85
4.2.1.	The screw press and its control parameters .....	85
4.2.2.	The yield obtained and energy consumption .....	90
4.2.3.	Oils and press cakes characterization .....	91
4.3.	Transesterification results.....	93
4.3.1.	Characterization.....	93
4.3.2.	<i>Linum usitatissimum</i> .....	94
4.3.3.	<i>Camelina sativa</i> .....	96
4.4.	Energetic results .....	97
5.	Conclusions.....	105
	References.....	109
	Acknowledgements .....	123

## *Preface*

During all the International PhD course (2009-2013 years) on “Agricultural Engineering” at the Department of Agri-food and Environmental Systems Management (DiGeSA), Mechanics and Mechanization Section, University of Catania, I was committed both in the study and in research and experimentation activities so as to contribute to the development and enlargement of my knowledge on different topics and mainly on the topic regarding “Renewable Energy Sources” with particular attention to the Biogas and Biodiesel production.

The interest in the subject on Biogas goes back to the preparation of the degree dissertation entitled “The biogas production from grape marc: first results with a pilot plant”, discussed in 2008 with the tutor Dr. Sabina Failla.

The knowledge acquired on the subject and further explored during the PhD course have found application in the preliminary phase of a regional project (PSR 2007-2013 - Mis. 124), projected in collaboration with some local farms, CNR and DiGeSA, entitled "Enhancement of Polyphenols and Wine Industry Waste for Biogas Production", of which the tutor Dr. Sabina Failla was scientific responsible. This project, although it was positively evaluated and approved in the 2011, was not funded for administrative reasons linked to some partners. So, the activities were concluded with a preliminary sizing of the anaerobic digestion plant which had to be made at a farm in the Etna area.

Lacking funds for research on Biogas but having some experience in the sizing of the plants, an assessment on the feasibility of realization of a big plant for the production of electricity from biogas in south-eastern Sicily has been started. The methodology and the results obtained in this work have been published, after being assessed by the referees, in the Proceedings of a National Conference and reported in Chapter III of the thesis. At the end of the chapter, further investigation and processing of the results are illustrated.

Further activities were carried out through two Stages abroad and a Summer School in order to increase the knowledge on innovative research in the Biogas sector. In detail, in 2011 I had the opportunity to go to the Utah State University in Logan, Utah, USA, for three months. During this period I worked at the Nutrition, Dietetics & Food Sciences Department with Prof. Conly Hansen, inventor of the Induced Bed Reactor (IBR) biogas plant, together with some his colleagues. In 2012, I spent one month at University College Cork, Ireland, where I collaborated with Dr. James Browne at the Environmental Research Institute in the Anaerobic Digestion Laboratory on a two steps Up-flow Anaerobic Sludge Blanket Digestion (UASB) reactor. Furthermore, in the same year I attended a Summer School on “Renewable Energy Sources and the Rational Use of Energy” at the Department of Agriculture, Forests, Nature and Energy (DAFNE) of the Tuscia University in Viterbo, Italy. The school was organized in cooperation with the Interdepartmental Research Center and Diffusion of Renewable Energy (CIRDER) of the Tuscia University in Orte, Italy.

Since the autumn 2011 I also was involved in the research activity of the AGROSO Project (Evaluation of high erucic acid of oilseed species in the Mediterranean environment for use in the energy sector as an alternative to mineral oil with a high environmental impact) funded by MiPAAF (Italian Ministry of Agriculture, Food and Forestry) of which Prof. Giampaolo Schillaci of the DiGeSA was local scientific responsible. The research project involved the evaluation of aspects related to the mechanization of cultivation and harvesting of oilseed crops, as well the evaluation of their energetic sustainability. The results of this work are published in part in the Proceedings of an International Conference and reported in the second Section of the last Chapter of the thesis.

With reference to the topics of the thesis, other research activities were carried out on the production of biodiesel from *Linum usitatissimum* L. and *Camelina*

*sativa* L. crops, with particular attention to the seeds pressing and the vegetable oils trans-esterification, through the availability of research projects of the University of Catania (PRA) assigned to the tutor. The methodology and the results obtained in this work are original and reported in third Chapter of the thesis.

In conclusion I can say that the PhD course was significant and rewarding opportunity for professional growth and personal development.



## *Aim of the thesis*

The topics of the PhD thesis have the objective of assessing three different aspects of the renewable energy sector: i) sizing of plants for the production of biogas through anaerobic digestion of agricultural waste and by-products of agro-industries; ii) evaluation of the mechanization and energetic aspects of the cultural practices and the harvesting of oil crops; iii) assessment of the sustainability of biodiesel production from *Linum usitatissimum* L. and *Camelina sativa*, with particular attention to the pressing of the seeds and the trans-esterification of vegetable oils.

As regards the first topic the aim of the work was to develop a procedure for verifying the availability of biomass for biogas production in a territory of Ragusa province (south-east Sicily) and to calculate the power of a co-generator engine for a biogas plant taking in consideration the quantity and the biogas yields of this biomass. In order to assess the quantity of biogas and electricity production per year two hypothesis have been evaluated. The first examines the available biomass for only some months of the year and the second examines the available biomass all the year round.

With regard to the second and third topic, the purpose of the research activities was primarily concerned with the following aspects:

- ✚ to calculate the quantitative parameters of mechanization such as work capacities, unitary time, fuel consumptions of farming practices
- ✚ to calculate the qualitative parameters of the work done during the seeding and harvesting such as the product obtained in respect of the product expected;
- ✚ to assess the cultivation sustainability of unconventional oil crops as *Linum usitatissimum* L. and *Camelina sativa*, in south-eastern Sicily for

biodiesel production in terms of energy used compared to that obtained, by means of EROI index;

- ✚ to analyse the mechanical pressing of seeds in terms of a) vegetable oil yields and chemical characteristics; b) machine work capacity; c) energy consumptions; d) characterization of the operating parameters of the screw press plant;
- ✚ to evaluation the trans-esterification process in terms of a) yield into biodiesel by varying the temperature of the process; b) yield into biodiesel by varying the amount of methanol and potash; c) physical-chemical characteristics of FAME according to EN 14214.

**Chapter 1: Focus on renewable energy:**  
**Biogas and Biodiesel**

## **1. The renewable energy in Italy and in the world**

### **1.1. The context**

In order to counteract the global warming and to safeguard the environment, the European Union Objectives for 2020 are to achieve the production of 20% of energy by renewable energy sources, to increase the energy efficiency of 20% and to reduce the greenhouse gases for at least 20% on the total. In 2010, the energy consumption from renewable sources in EU 27 was 12.5%, while the greenhouse gas emissions declined by 15% compared to 1990 (GSE, 2013).

The agro-forestry biomass represent an energy source usable in several sectors (for example electrical, thermal and mechanic energy production), but the Italian energetic situation is under dimensioned than its possibility (Zezza, 2008).

To achieve the main objectives set under the NES (National Energy Strategy), which was launched on 8 March 2013, it will need to take into consideration some strategic parameters including that relating to the energetic valorisation of biomass for the production of biofuels. It is also to highlight that the bio-energy production must create jobs as well as important opportunities for safeguarding the land and the national landscapes, especially in marginal lands (Monni, 2013).

Even if the biofuels production by energy crops cultivation need of big amount of hectares, in the last 30 years, the number of farms and the total hectares cultivated in Italy are decreasing. In 1982 there were about 3.1 M of farms that cultivated almost 16 M of hectares. Nowadays, the number of farms are around 1.6 M with 12.8 M hectares cultivated (ISTAT, 2010).

## 1.2. Statistical data

It's a spread opinion that with the term *biomass* are considered all the organic matter, both the recoverable residuals and the energy crops. It was estimate that in the world the potential annual energy production from biomass is about  $298 \times 10^9$  GJ and of it about  $31 \times 10^9$  GJ from recoverable residual biomass, and about  $267 \times 10^9$  GJ from energy crops. In this context, Europe represent about 5% of the total world potential production, and in particular about 12% of the energy producible from recoverable residuals, and about 4% of the energy producible from energy crops (IEA, 2010).

If we consider the biomass potential in the world, some disadvantages are clear: the periodic production with uncertain yield, the diffuse nature of the energy source, the further processing that is needed, the competition with food production and the highly variable energy per unit mass or volume (Michaelides, 2012).

In Europe, agriculture plays an important role in providing renewable energy resources. The quote of *renewable energy* deriving from this sector grew, in recent years, from 3.6% in 2005 to 10.5% in 2010. According to the GSE, in 2012, renewable resources production from agriculture brought in nearly 12,250 GWh (GSE, 2012; Ortenzi, 2013).

According with the Baseline scenario of the Primes study, in 2020 the Italian *energy consumption* could reach 145.6 MTep. The Italian goal is to increase the energy use efficiency, to keep the energy consumption around 133 MTep/year. It could be possible promoting cogeneration, favouring the self-energy for small and medium-sized enterprises, strengthening the mechanism of energy efficiency certificates, promoting the new building saving energy and the energy upgrading of existing buildings, promoting the new products highly efficient. Moreover, the 17% of the energy consumption must be from renewable sources and that means about 22.62 MTep. To

achieve these objectives will be crucial to increase the use of renewable sources for warming or cooling and also the use of biofuels in transport sector (PAN, 2010).





In Italy, total renewable energy produced in 2011 was 82.96 TWh that represent the 23.5% of the total energy required and 8% more than 2010. The result was been bigger than the goal for the same year, fixed in 19.6% of the total energy required. For this reason the goal for 2020 of 26.4% of r.e. production could be increased.

In 2011, the *electricity* from Bioenergy achieved 10.8 TWh that is the 13% of the total renewable energy produced. In particular, in the same year, 4.7 TWh of r.e. were produced from biomass, 3.4 TWh from biogas and 2.7 TWh from bioliquids, that are respectively 1.3%, 1% and 0.8% of the total energy consumption.

At the end of 2011, the *renewable energy plants* were 335,151 of which 330,196 were solar energy plants. The total energy power installed was about 40 TW and of these 2.82 TW came from power was from Bioenergy. In detail, there were 1,213 bioenergy plants, 170 biomass, 819 biogas and 275 bioliquids plants. It is interesting to underline that the numbers of bioenergy plants was almost double than the year before (GSE, 2012).

## 2. The Biofuels

According with the European Directive 2009/28/EC “energy from renewable sources” means energy from renewable non-fossil sources that are named:

-  Wind energy;
-  Solar energy;
-  Aerothermal energy;
-  Geothermal energy;
-  Hydrothermal and ocean energy;

- ✚ Hydropower energy;
- ✚ Biomass energy: biofuels (bioliquids and biogases) and bio-solids;
- ✚ Landfill gas;
- ✚ Sewage treatment land gas and biogases.

The biofuels include liquid or gaseous fuel for transport produced from biomass. In detail, the bioliquids are liquid fuel for energy purposes other than for transport, including electricity, cooling and heating, produced from biomass. Instead the biogases are a fuel gases produced from biomass and/or from the biodegradable fraction of waste, that can be purified to natural gas quality, to be used as biofuel, or wood gas.

On the basis of the raw materials and the technologies needed for their production, biofuels are classified into:

- ✚ First generation biofuels are biodiesel, crude vegetable oils, bio-ethanol, bio-ETBE and biogas produced from food crops such as wheat, sugar and corn; these are the most widely used feedstock for fermentation fuels, while seed rape oil has proved a very effective crop for use in biodiesel.
- ✚ Second generation biofuels are biohydrogen, syngas, bio-oil, biomethanol, bio-DME, biobutanol and Fischer-Tropsch diesel produced from agricultural residues and non-food crops such as wood, organic waste, food crop waste and specific biomass crops.
- ✚ Third generation biofuels are biodiesel and bioethanol produced from specially engineered energy crops such as algae. The algae are culture to act as a low-cost, high-energy and entirely renewable feedstock. Algae can be grown using land and water unsuitable for food production.
- ✚ Fourth generation biofuels are produced from microorganism genetically modified. These production are aimed at not only producing sustainable energy but also a way of capturing and storing

CO<sub>2</sub>. Biomass materials, which have absorbed CO<sub>2</sub> while growing, are converted into fuel using the same processes as second generation biofuels.

Table 2.1 shows the main common biofuels and conventional fuels and their energy content per unit.

**Table 2.1.** Energy content of transport fuels

<b>Biofuel and raw materials</b>	<b>Energy content -lower calorific value (incidence from renewable sources if different from 100%)</b>	
	<b>MJ/kg</b>	<b>MJ/l</b>
Bioethanol; ethanol produced from biomass	27	21
Bio-ETBE ethyl-tertio-butyl-ether produced on the basis of bio-ethanol	36 (37%)	27 (37%)
Biomethanol; methanol produced from biomass	20	16
Bio MTBE; methyl-tertio-butyl-ether produced on the basis of bio-methanol	35 (22%)	26 (22%)
Bio-DME, dimethylether produced from biomass	28	19
Bio-TAEE, tertiary-amyl-ethyl-ether produced on the basis of bioethanol	38 (29%)	29 (29%)
Biobutanol, butanol produced from biomass	33	27
Biodiesel, methylester produced from vegetable or animal oil, of diesel quality	37	33
Fischer-Tropsch diesel, a synthetic hydrocarbon or mixture of synthetic hydrocarbons produced from biomass	44	34
Hydrotreated vegetable oil, vegetable oil thermochemically treated with hydrogen	44	34
Pure vegetable oil, oil produced from oil plants through pressing, extraction or comparable procedures, crude or refined but chemically unmodified, when compatible with the type of engines involved and the corresponding emission requirements	37	34
Biogas, a fuel gas produced from biomass and/or from the biodegradable fraction of waste, that can be purified to natural gas quality, to be used as biofuel, or wood gas	50	-
<b>Conventional Fuel</b>		
Petrol	43	32
Diesel	43	36

(Font: 2009/28/EC)



## 2.1 The Biogas

The biogas is a mix of gas product by anaerobic fermentation of different kind of biomass. It is formed by 47-57% of methane (CH<sub>4</sub>), 37-43% of carbon dioxide (CO<sub>2</sub>), 1-17% of nitrogen (N<sub>2</sub>), <1% of oxygen (O<sub>2</sub>) and 36-230 ppm of hydrogen sulfide (H<sub>2</sub>S) (Rasi, 2009). Furthermore, the anaerobic fermentation produces the digestate that represents the organic matter undigested during the process.

The anaerobic digestion process is a reaction that occurs spontaneously in nature, for example in the swamps where the bubbles gas go up until the water surface, or in the ruminant animals stomach by the activity of the anaerobic bacteria during the digestion of organic matter. It is known that the microorganism established in the digestive system of an adult cows can produce up to 500 liters of gas per day (Barker, 1956).

Landfills are other sites where there is a large biological methane production. In this case the amount of gas should be carefully monitored both for GHG emissions and for its explosive characteristic in confined environment in concentration above 5%. Moreover, this gas is dangerous both for people health and for vegetal roots life when it is present underground (Pandolfo et al., 2004).

The correct management of the anaerobic digestion process, in addition to the biogas production and utilization, could produce at least others two advantages.

In fact, the digestate have good stability quality and organic matter content and could be distributed in the soil without risks for the crops. The anaerobic digestion results in a significant reduction of the livestock manure toxicity. The process determines the anaerobic stabilization of the organic matter and contributes to the deodorization of the slurry. As a result, the emission of

unpleasant odors are reduced thanks to the metabolization and solubilization of organic compounds that cause bad odors (Taiganides et al., 1979).

The devitalization of weed seeds and the reduction of pathogenic charge are two other positive effects from the anaerobic digestion process. The reduction is not complete and depends mainly on the temperature and the retention time of the process. In any case, there is a reduction of pathogens of about 90%. All agronomic and environmental positive effects are more accentuated in the anaerobic digestion plants that operate with mesophilic (35-40°C) or thermophilic (50-55°C) temperature, rather than in systems that operate with psychrophilic (4-15°C) temperatures (Wilkie, 2005).

### **2.1.1 The biological process**

The anaerobic digestion is a process of organic matter degradation that is operated by a pool of specialized anaerobic microorganisms. Different steps occur in the process and each step have their microorganisms that carried out the necessities reactions. The steps are hydrolysis, acidogenesis, acetogenesis and methanogenesis (Castelli and Negri, 2011; Chiumenti et al., 2007). The anaerobic digestion process is shown schematically in figure 1.

The hydrolysis phase could be carried out both from anaerobic and aerobic facultative bacteria. They produce enzymes to degrade complex molecules such as polysaccharides, proteins, and fat into simple organic molecules more easy to be digested such as monosaccharides, amino acids, peptides, glycerol and fatty acids. When the complex molecules are lignin, cellulose or other with slow degradation time, this phase can become the limiting factor of the process speed (Vismara, 1976).

Acidogenesis and acetogenesis are two reactions carried out by facultative anaerobic bacteria called “acid formant”. They transform the hydrolysis products into organic acids such as pyruvic acid, propionic acid and

acetolactate. This kind of bacteria have, also, the role of consumer of the residual oxygen content in the digester that is necessary for the subsequently phase of methane production (Castelli and Negri, 2011; Chiumenti et al., 2007).

In this phase, the pH decrease slightly and part of the energy contained in the starting molecules is released in the form of molecules of  $\text{NADH}^+$  and ATP (Daffonchio, 2008).

The last step of the biogas production chain is the methanogenesis. In this phase is produced a molecule greatly reduced and full of energy such as methane. In detail the methanogenesis consists in two distinct phases. In the first step the substrates, formed in the acidification phase, are transformed into amines, ammonia, acids, carbonates, carbon dioxide, methane, hydrogen, nitrogen, mercaptans, indole, skatole and hydrogen sulfide. In the second step the amines, ammonia, carbonates acids, the anhydride carbon, hydrogen and nitrogen are finally processed into methane and carbon dioxide (Kormanik, 1968).

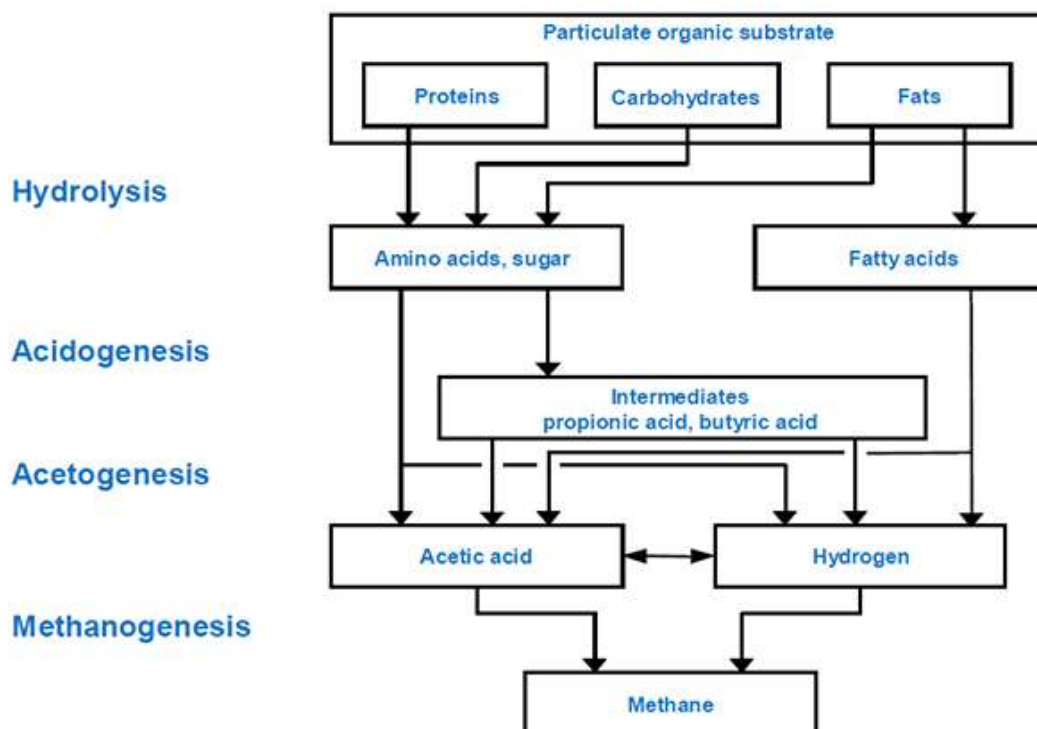

Figure 2.1.1.1. Scheme of the anaerobic digestion process

Numerous bacterial strains are involved in methanogenesis steps. The most important use acetic acid as substrate because from this compound has origin the 70% of the methane. The most known are *Methanobacterium formicum*, *M.soehngeni*, *M. ruminantium*, *Methanococcus mazei*, *M. vanniellii*, *Methanosarcina methanica*, *M. barkerii* and *Methanotrix spp.* (Scammell, 1975).

The management of some chemico-physical parameters is important to keep constant the process. The most important are:

- ✚ Quantity and quality of the biogas; when the quantity of the gas goes down than the normality or the percentage of methane decreases under value of 50% it may be that something of wrong is happening inside the digester (Castelli and Negri, 2011).
- ✚ Temperature; high temperature process favorite the microorganisms activity and the biogas production. Moreover, the temperature set point must be kept constant because the raw matter degradation and the HRT (Hydraulic Retention Time) are strictly related with it (Zennaki et al., 1996).
- ✚ pH and buffer capacity; pH values around 6-8 are symptoms of process stability. The buffer capacity of the system depend of the weak acids content. These acids are at the same time products and substrates for different kind of bacteria (Speece, 1996).
- ✚ Ammonia (NH<sub>3</sub>); the methane production decrease progressively until the stop when the concentration of this molecule achieve and exceeds values of 1.5-4.0 g/l (De Baere et al., 1984).
- ✚ Volatile fatty acids (VFA); high concentration of VFA shift the equilibrium of the process towards the acidogenesis phase with consequent lowering of the pH and stop of the methane production (Gourdon and Vermande, 1987).

- ✚ Ratio VFA/alkalinity; the optimum is ratio of 0.3-0.4. Higher values mean too much substrates. At the opposite, lower value mean not enough substrates (Castelli and Negri, 2011).
- ✚ Ratio C:N; microorganisms use Carbon 25-30 times more than Nitrogen for them growing. It means that insufficient N inhibits the process. The optimum ratio is 20-30:1 (Wilkie et al., 1986).
- ✚ Micronutrients; high content of micronutrients ( $\text{Cu}^{2+}$ ,  $\text{Fe}^{2+}$ ,  $\text{Fe}^{3+}$ ,  $\text{Mg}^{2+}$ ,  $\text{Mn}^{2+}$ ,  $\text{Co}^{2+}$ ,  $\text{Al}^{3+}$ ,  $\text{Zn}^{2+}$ ) generally increase the biogas production (Wong and Cheung, 1995)
- ✚ Toxicity of the growth environment;  $\text{H}_2\text{S}$  content of 8-22g/kg<sub>ts</sub> is correct for the process performance (Castelli and Negri, 2011).

### 2.1.2 Usable biomass

The European Directive 2009/28/EC established that “biomass” means the biodegradable fraction of products, waste and residues from biological origin from agriculture (including vegetal and animal substances), forestry and related industries including fisheries and aquaculture, as well as the biodegradable fraction of industrial and municipal waste.

As already discussed in the previous paragraph, the characteristics of the biomass plays an important role for its degradability and biogas production speed. In fact, the majority of the big dimensions biogas plants are designed to work with a mixture of livestock manure and corn silage. The first provides the continuous integration of useful microorganisms, instead the latter, thanks to their high energy content and degradability, maximize the yield of the plant. However, because of the high production costs of silages the plants that recover and utilize crop residues and agro-industrial waste are increasing (Balsari et al., 2011).

These residues can be forage, unmarketable fruit and vegetable, silos percolates and straw. Moreover, agro-industrial waste such as cheese whey, liquid waste of the production of fruit juices or alcohol distilling, grape marc, tomato hulls, organic slaughter waste (fat, blood, stomach contents, guts, etc.). These can all be added as co-substrates in the digestion of animal manure or sewage sludge.

Furthermore, pre-treatments can be useful to degradate the complex molecule and to facilitate their conversion into biogas:

- ✚ Physical pre-treatments: they provide the breaking of the complex molecules into smaller compounds. These treatments can be mechanical (such as milling, extrusion, ultrasonication, electrokinetic forces) or thermal type (such as steam explosion, pressure cooking).
- ✚ Chemical pre-treatments: they increase the biodegradability of complex molecules. These treatment include acids treatment, bases treatments and oxidation treatment.
- ✚ Biological pre-treatments: thy consist of adding of microorganisms, hydrolysis enzymes or probiotics additives in the pre-loading tank. These biological agents provide the hydrolysis of the complex organic molecules (Balsari et al., 2011).

Finally, the resulting digestate of the anaerobic digestion process, because of its great amount of organic carbon and mineral nutrients can be useful as fertilizer on agricultural land (Piccinini et al., 2008) .

### 2.1.3 Plant typologies

The anaerobic digestion techniques can be divided in three big group:

- ✚ Humid digestion: when total solids<sup>1</sup> are less than 10%;
- ✚ Semi-dry digestion: when total solids are between 10% and 20%;
- ✚ Dry digestion: when total solids are more than 20%.

All the digestion techniques may be single-stage or two-stage. In the first case, all the reactions occur in the same digester at the same time. In the second case, the hydrolysis and part of acidification are carried out in a first digester, while the methanogenesis is carried out in a second digester (Piccinini et al., 2008).

The temperature is another distinctive parameter for the digestion process:

- ✚ Thermophilic digestion: temperature between 50°C and 55°C;
- ✚ Mesophilic digestion: temperature between 35°C and 40°C;
- ✚ Psychrophilic digestion: temperature between 4°-15°C.

Depending on the digestion temperature the HRT<sup>2</sup> can range from 15 to 90 days (Wilkie, 2005).

Furthermore, the biogas plants may be at batch or continuous systems. In the batch system the plant is filled at the beginning of the process and empty when the biogas production is concluded. This system type is usually used for dry digestion. In the continuous system the biomass is fed daily into the digester and an approximately equal volume is pushed out (Chiumenti et al., 2007; Navarotto, 2011).

---

<sup>1</sup> Measure of both suspended and dissolved organic and inorganic solids.

<sup>2</sup> where V= volume of the tank and Q= daily flow.

The basic components of a biogas plant fed with livestock manure and dedicated crops or agro-industrial waste are:

- ✚ Slurry storage tank: usually the preexistent tank of the cattle farm are used (Chiumenti et al., 2007).
- ✚ Storage trenches or container biomass: the most common technique for solid biomass conservation is the ensilage. In the case of corn silage the storage capacity should be at least enough for 400 days of digester loading (Navarotto, 2011).
- ✚ System for solids and liquids substrates loading: usually solids and liquids substrates are loaded separately into the digester. For the first loading hoppers are used to levy the biomass from a preliminary mixing container and to load it inside the digester. In the second case a pump draws the liquid directly from the storage tank (Navarotto, 2011).
- ✚ Digester: it can be realized with different materials of construction (steel, concrete, etc..) and often the type of the process (temperature, HRT, type of mixing, etc..) determines its typology (Navarotto, 2011).
- ✚ Gasholder: it is a container for temporary gas storage before its use. In the cases of CSTR (Completely Stirred Tank Reactor) digesters it usually consist of a double membrane applied on the digester (Chiumenti et al., 2007).
- ✚ Combined Heat and Power (CHP) engine: this machine known also as cogenerator, uses the biofuel (in this case biogas) to simultaneously generate electricity and heat (Bocci et al., 2011).
- ✚ Connection to the electrical national grid (Figure 2.1.3.1).



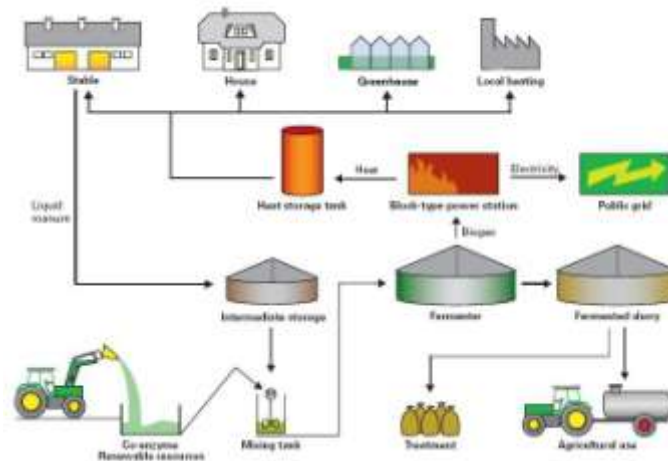

Figure 2.1.3.1. Biogas plant design

The vast majority of the operating farm plants in Italy are CSTR type (Completely Stirred Tank Reactor), continuous fed and single-stage (Fabbri and Piccinini, 2012)

#### 2.1.4 Biogas quality and its use

The methane content in the biogas can vary significantly, 40-75%. Generally, the average is around 50-60%. The energy obtainable from the cogenerator combustion of 1 Nm<sup>3</sup> can reach values of 2 kWh electric and 17,000 kJ of thermal energy. Obviously the percentage of methane has a direct impact on the amount of energy producible (Chiumenti et al., 2007).

Before the storage, the biogas must be treated to eliminate foreign substances. First of all, the dehumidification is necessary to eliminate the water steam. Moreover, hydrogen sulfide (H<sub>2</sub>S) is soluble in water forming sulfuric acid (H<sub>2</sub>SO<sub>4</sub>) that is very corrosive for several materials and so dangerous for the cogenerator (ENEL & CRPA, 1996).

However, the H<sub>2</sub>S present in the biogas, even if in very small quantity, is quite corrosive against the cogeneration system, therefore this molecule has to be removed from the gas mixture.

- ✚ The chemical-physical method of H<sub>2</sub>S removal consists of absorbent filters. The materials that retain H<sub>2</sub>S can be iron filings, wood chips, active carbon or other absorbent materials (De Poli, 1989). The active carbon can be impregnated with different molecule that increase the absorbent capacity against the H<sub>2</sub>S. Among these, 10% potassium hydroxide (KOH), divalent copper (Cu II) and hexavalent chromium (Cr VI) have successfully tested (Monteleone et al., 2011).
- ✚ Air introduction in the digester is another biogas purification method. Small amount from 2 to 4% of air of the biogas volume are used. The H<sub>2</sub>S reacts with the air to form sulfur crystals that precipitate and can subsequently be removed (Chiumenti and Chiumenti, 2004).
- ✚ Biological purification is a technology often used for biogas. Chemotrophic thiobacteria (*Thiobacillus spp.*) are able to remove H<sub>2</sub>S from biogas. They need to a carbon source (CO<sub>2</sub>) for the redox reaction that produce SO<sub>4</sub><sup>2-</sup> and S<sup>0</sup> as waste (Zhao et al., 2010).

Free from the main contaminants, biogas can be used for combustion in a boiler or in a cogenerator, otherwise it may be placed in the national gas grid.

The boiler combustion produce thermal power that may be used for farming or digester heating (Chiumenti et al., 2007).

Finally, the biogas may be placed in the national gas grid. For this purpose the biogas must be purified to have at least 99% of methane. The purification methods are:

- ✚ Adsorption pressure altered: it's a physical depuration method which uses activated carbons. It allows to achieve 96% of gas purity.
- ✚ Wash up to pressure: it's a physical depuration method that consist of the gases absorption by using high pressure water. It allows to achieve 94% of gas purity.

- ✚ Selexol washing: it's a physical depuration method that consist of the gases absorption by using glycol ether. It allows yield of 95% of methane.
- ✚ Amines washing: it's a chemical depuration method that use the power of absorption of the amines. It allows to get yields bigger than 99% (Leitner, 2008).

## 2.2 The Biodiesel

The use of vegetable oils for powering high speed diesel engines such as trucks, city buses or coaches, and light motor vehicles such as vans and cars, is not recommended because the extraction is often obtained by solvent use that determine presence of esters and glycerin in the oil (Fedeli and Girelli, 2001). Biodiesel production can overcome this limitation of the vegetable oil.

Biodiesel is a biodegradable and alternative diesel fuel made from vegetable oils or waste lipid and methanol. It is considered as a sustainable, clean and low-emissions energy source. Biodiesel is also known as FAME (Fatty Acids Methyl Esters). The transesterification, especially alkali-catalyzed one, is the most common process to produce biodiesel (Atadashi et al., 2011).

Numerous researches about biodiesel production and the process optimization were carried out. Several Authors have used animal fat or tallow for the biodiesel production for their researches (Fangrui et al., 1998; Goodrum, 2002, Liu et al., 2011). Other Authors have evaluated the feasibility and the quality of biodiesel obtained from waste cooking oil (Zhang et al., 2003). However the main substrate used for biodiesel production is the vegetable oil. The most common vegetable oils used are: sunflower oil (Antolín et al., 2002; Rashid et al., 2008; Vicente et al., 2007), rapeseed oil (Banković-Ilić et al., 2012; Leung et al., 2010) and palm oil (Darnoko and Cheryan, 2000; Reza Shambazi et al., 2012).

In recent years, some alternative oil crops, such as *Jatropha curcas*, *Linum usitatissimum*, *Camelina sativa*, *Pogamia pinnata* and *Camellia japonica* were tested (Chitra et al., 2005; Chung, 2010; Kumar et al., 2013; Leung et al., 2010; Meher et al., 2007; Nakpong and Wotthikanokkhan, 2010).

Furthermore, many studies have been carried out to maximize yield and quality of the biofuel. For example, the use of recent membrane technologies used in refining biodiesel could represent in the future the way to obtain very good biodiesel quality (Atadashi et al., 2011). Other Authors realized an experimental plant of biodiesel production integrated with an ultrasound system was realized. With this system, transferable on a real scale, it was possible to obtain a reduction of the reaction time and the percentage of triglycerides in biodiesel (Riva et al., 2009). Also the raw materials must be of good quality, preferably with low water content. Otherwise a refining treatment may be necessary (Atadashi et al., 2012). However, small quantities of water favor the aggregation of free glycerol to form large particles in the FAME phase. In this way, the application of membrane separation process can achieve very good results (Saleh et al., 2010).

### 2.2.1 The Biological process

In transesterification reaction (Figure 2.1.1.1) the fatty acids of the vegetable oils triglycerides react with methanol or ethanol to form methyl esters and glycerol (Foppa Pedretti et al., 2007; Mapelli e Pecchia, 2011; Ravasio e Zacheria, 2011).

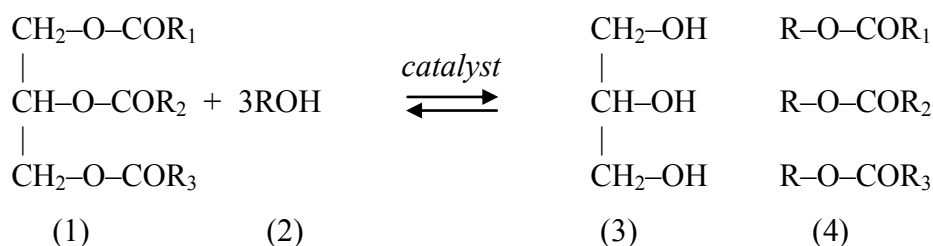

**Figure 2.1.1.1.** Transesterification reaction of triglycerides (1) and methanol (2) into glycerol (3) and methylesters (4). R<sub>1</sub>, R<sub>2</sub> and R<sub>3</sub> are long-chain hydrocarbons.

This reaction is reversible and one molecule of triglyceride reacts with three molecules of alcohol (ratio 3:1). In general, the reaction is conducted in methanol excess to shift the equilibrium on the right (ratio triglycerides alcohols 4:1 or more) (Zhang et al., 2003). Moreover, the reaction can be alkali-catalyzed, acid-catalyzed or enzyme catalyzed (Banković-Ilić et al., 2012).

The alkali-catalyzed transesterification process is obtained by using a base as catalyst. The main common bases used are NaOH and KOH. In this case during the transesterification an undesirable reaction can occur (Figure 2.1.1.2). The free fatty acid (FFA) can react with the catalyst to form soap and water. The soap reduce the yield, lowers the catalyst availability and don't allow the separation of the glycerol from the methylester.

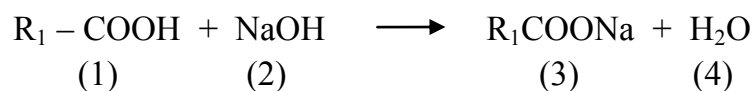

**Figure 2.1.1.2.** Undesirable saponification reaction. (1) FFA, (2) sodium hydroxide (catalyst), (3) soap, (4) water.

Moreover the water naturally present in the oil and the water produced in previous reaction can react with triglycerides to form diglycerides and FFA ready to produce new soap (Leung et al., 2010).

The acid-catalyzed transesterification process provide for the use of an acid as catalyst. This process is cheaper than the previous one because don't produce free acids in the FAME and so don't require of subsequent purification. At the opposite the slowness of the reaction catalyzed by an acid makes the process uneconomic (Ravasio and Zaccheria, 2011).

Finally, the enzyme catalyzed process is mediate by a lipase. In this case the reaction is carried out in non-aqueous environment. The advantages of this process are the easy recovery of the glycerol, the possibility to use oil with high content of FFA and the minimal quantity of waste water generated. In the

other hand, the disadvantage is the high cost of the enzymes (Banković-Ilić et al., 2012).

### **2.2.2 Vegetable oil for biodiesel production**

The oil extraction from erucic seeds can be carried out in three different ways: mechanical extraction, solvent extraction and enzymatic extraction. The first two techniques are the most commonly used for commercial vegetable oil extraction (Atabani et al., 2012).

Generally for research purpose, the mechanical extraction method with one or more screw presses in series is used (Karaj and Muller, 2011; Kasote et al., 2013; Sigh and Bargale, 2000). Other Authors combined the two methods, mechanical pressing and solvent extraction in a single step, with the purpose to increase the yield and the quality of the oil obtained (Kartika et al., 2010).

A screw press can extract from 68 to 80% of the seed oil content. This broader range is due to the number of screw presses that has the machine. Moreover the design of mechanical extractor is often suited for some particular seeds, therefore the yield is affected when mechanical extractor is used for other seeds (Atabani et al., 2012).

Some Authors say that for linseed the use of a single, double or triple press can increase the yield of extracted oil from 19.2 to 31.9%. Moreover they add that there are not really difference between double and triple press and the application of more than two presses is not economically convenient (Kasote et al., 2013).

The machine is generally formed by a rotative screw actionated by a motor that push the seeds against a press head while the press cake goes out through the terminal nozzle. The pressure due to the resistance of seeds against the press head generate an increase of temperature that in some case could achieve values up to 140°C. The pressure is influenced both by the speed rotation of the screw and by the nozzle diameter (Karaj and Muller, 2011).

### 2.2.3 Biodiesel production chain

Biodiesel can be produced in four ways: blending, micro-emulsion, pyrolysis and transesterification. However, reversible transesterification reaction is the most used technique to convert vegetable oil or animal fat into biodiesel.

In the transesterification process, several variables can influence the reaction and determine the methyl esters yield. These variables are: type of alcohol, molar ratio of alcohol:oil, catalyst type and quantity, reaction temperature, stirrer intensity, time and pressure of the reaction and water content in the oil.

The main different methods of production are:

- ✚ Homogeneously catalyzed transesterification process. This is the most used method for industrial biodiesel production. The catalyst is soluble in the reaction mixture and it can be carried out in two different ways:
  - ✓ One-step process, the catalyst may be a base or an acid;
  - ✓ Two-step process, the catalyst are both acid and base, one for step;
- ✚ Heterogeneously catalyzed transesterification process. This method is used for feedstock that contains more than 1% of free fatty acids. The catalyst is not soluble in the reaction mixture and can be carried out in two ways:
  - ✓ One-step process, the catalyst may be a base or an acid;
  - ✓ Two-step process, the catalyst are both acid and base, one for step;
- ✚ Enzyme catalyzed transesterification process. The reaction is catalyzed by enzyme, usually lipase, that carried out the alcoholysis and esterification at the same time in non-aqueous environment.
- ✚ Supercritical transesterification process. In this method high temperature and pressure are applied. There are several advantages but the production plant is very expensive (Banković-Ilić et al., 2012).

## 2.2.4 International standards

The standard EN 14214 specifies requirements and test methods of the marketed and distributed FAME. The standard is in accordance with the requirements UNI EN 590 and if Biodiesel respects these requirements is usable both at 100% concentration in engine and mixed with diesel fuel for motor vehicles (Table 2.2.4.1).

**Table 2.2.4.1.** Standard requirements for vehicles biofuels

Property	Units	Lower limit	Upper limit	Test-Method
FAME content	% (m/m)	96,5	-	EN 14103
Density at 15°C	kg/m <sup>3</sup>	860	900	EN ISO 3675 / EN ISO 12185
Viscosity at 40°C	mm <sup>2</sup> /s	3.5	5.0	EN ISO 3104
Flash point	°C	>101	-	EN ISO 2719 / EN ISO 3679
Sulfur content	mg/kg	-	10	EN ISO 20846 / EN ISO 20884
Carbon residue remnant (at 10% distillation remnant)	% (m/m)	-	0.3	EN ISO 10370
Cetane number	-	51.0	-	EN ISO 5165
Sulfated ash content	% (m/m)	-	0.02	ISO 3987
Water content	mg/kg	-	500	EN ISO 12937
Total contamination	mg/kg	-	24	EN 12662
Copper band corrosion (3h at 50°C)	rating	Class 1	Class 1	EN ISO 2160
Oxidation stability, 110°C	hours	6	-	prEN 15751 / EN 14112
Acid value	mg KOH/g	-	0.5	EN 14104
Iodine value	-	-	120	EN 14111
Linolenic acid Methylene	% (m/m)	-	12	EN 14103
Polyunsaturated (≥4 double bonds) methylester	% (m/m)	-	1	EN 14103
Methanol content	% (m/m)	-	0.2	EN 14110
Monoglyceride content	% (m/m)	-	0.8	EN 14105
Diglyceride content	% (m/m)	-	0.2	EN 14105
Triglyceride content	% (m/m)	-	0.2	EN 14105
Free Glycerine	% (m/m)	-	0.02	EN 14105 / EN 14106
Total Glycerine	% (m/m)	-	0.25	EN 14105
Group I metals (Na+K)	mg/kg	-	5	EN 14108 / EN 14109 / EN14538
Group II metals (Ca+Mg)	mg/kg	-	5	EN 14538
Phosphorus content	mg/kg	-	4	EN 14107

(Font: EN 14214)



Another standard for biofuels uses is the EN 14213 that regulates the characteristics of the biofuels for heating purpose. The parameters limit of this standard are showed in table 2.2.4.2.

**Table 2.2.4.2.** Standard requirements for heating biofuels

Property	Units	Lower limit	Upper limit	Test-Method
FAME content	% (m/m)	96,5	-	EN 14103
Density at 15°C	kg/m <sup>3</sup>	860	900	EN ISO 3675 / EN ISO 12185
Viscosity at 40°C	mm <sup>2</sup> /s	3.5	5.0	EN ISO 3104
Flash point	°C	120	-	EN ISO 3679
Sulfur content	mg/kg	-	10	EN ISO 20846 / EN ISO 20884
Carbon residue remnant (at 10% distillation remnant)	% (m/m)	-	0.3	EN ISO 10370
Sulfated ash content	% (m/m)	-	0.02	ISO 3987
Water content	mg/kg	-	500	EN ISO 12937
Total contamination	mg/kg	-	24	EN 12662
Oxidation stability, 110°C	hours	4	-	EN 14112
Acid value	mg KOH/g	-	0.5	EN 14104
Iodine value	g I <sub>2</sub> /100g	-	130	EN 14111
Polyunsaturated (≥4 double bonds) methylester	% (m/m)	-	1	
Methanol content	% (m/m)	-	0.2	EN 14110
Monoglyceride content	% (m/m)	-	0.8	EN 14105
Diglyceride content	% (m/m)	-	0.2	EN 14105
Triglyceride content	% (m/m)	-	0.2	EN 14105
Free Glycerine	% (m/m)	-	0.02	EN 14105 / EN 14106
Cold filter plugging point (CFPP)	°C	-	-	EN 116
Pour point	°C	-	0	ISO 3016
Net calorific value (calculated)	MJ/kg	35	-	DIN 51900 1-2-3

(Font: EN 14213)

## **Chapter 2: Stages abroad**

## 1. The American Experience

### 1.1 Aim of the stage

From the 11<sup>th</sup> July 2011 to the 8<sup>th</sup> October of the same year I lived in the campus of the Utah State University in Logan, Utah, USA. There I worked at the Nutrition, Dietetics & Food Sciences Department, and above all with Prof. Conly Hansen and Dr Jianming Zhong.

It must be stated that Prof. Conly Hansen, Prof. Carl Hansen, Prof. Edward Watts and Prof. Kevin Pack are the inventors of the Induced Sludge Bed Anaerobic Reactor (IBR) biogas plant US patent No.US7452467 B2. In Europe the invention is protected by the EP 2 099 718 B1 Patent and named “Upflow bioreactor with septum and pressure release mechanism”.

During the three months that I spent in USA, I worked at the Research Centre located at the Logan Lagoons Wastewater Treatment Plant, away from Logan town. In this centre there are 4 IBR reactors, two of about 3.7 m<sup>3</sup> (Figure 1.1.1) and two of about 60 liters (Figure 1.1.2).



**Figure 1.1.1.** 3.7 m<sup>3</sup> IBR vessels



**Figure 1.1.2.** 60 liters IBR vessels

The two green IBR have been used for long period biomass tests, while the other two have been used for quick potential methane production tests.

In detail, I have actively collaborated to the feeding process of the two size of plants and to the monitoring of the most common parameters under control: temperature, pH, biogas production and hydraulic retention time.

## 1.2 The IBR biogas plant

The IBR is an upflow bioreactor that provide the rapid decomposition of organic wastes with low to no instances of plugging. Figure 1.2.1 illustrates an exemplary bioreactor.

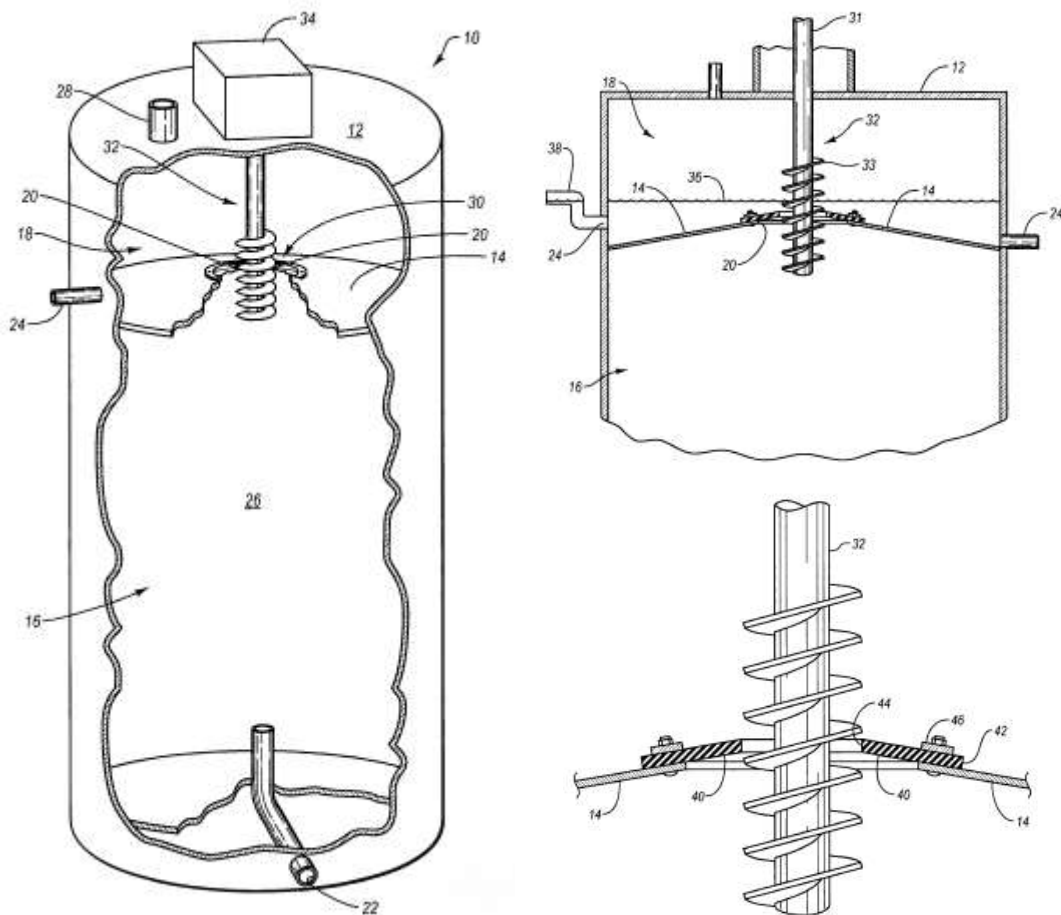

**Figure 1.2.1.** Scheme of the IBR plant. On the left the full vessel, on the right the detail of the septum and the rotative auger

The IBR consist in a steel vertical vessel in which an organic material (*e.g.*, sewage) can be introduced and held for treatment. A septum is positioned inside the vessel to form a lower chamber and an upper chamber. An aperture in the septum provides fluid communication between the two chambers. The central rotating auger, passing through the aperture, facilitates the retention of suspended solids in the effluent.

The inlet is positioned at the bottom of the lower chamber in order to introduce the raw material to be digested. The outlet is placed in upper chamber in order to allow the effluent to come out of the bioreactor. Because of the slow speed of the raw material replacement, a sludge blanket of bacteria can grow in the biomass of the lower chamber. The organic material (*e.g.*, animal waste) is slowly forced up through the sludge blanket where it is decomposed into smaller organic molecules and biogas.

Each IBR have been equipped with a pHmeter (Figure 1.2.2), a control temperature system (Figure 1.2.3) and a biogas mass flow meter (Figure 1.2.4 and 1.2.5).



**Figure 1.2.2.** pHmeter display



**Figure 1.2.3.** Control temperature system



Figure 1.2.4. Big reactor mass flow meter



Figure 1.2.5. Small reactor mass flow meter

### 1.3 The experimental activities

In the first two months we powered the two small size IBR with cheese waste and algae. In detail, the cheese waste comes from the university campus dairy (Figure 1.3.1) where is produced the famous Aggie Ice Cream. While the algae comes from the Logan Lagoon wastewater treatment (Figure 1.3.2) were they grown and are useful to purify the wastewater.

In detail, we collected the cheese waste every week and stored it in a fridge at the Logan lagoon research centre because of the low pH of the raw material. Instead, the algae that we used were collecting with a concentrator machine built for a wastewater treatment project and waiting for the patent (no photo). Moreover, we tried the effect of different concentration of algae and cheese waste on the pH and biogas production (from 20% cheese waste and 80% algae to 80% cheese waste to 20% algae).



**Figure 1.3.1.** Cheese waste collecting tank



**Figure 1.3.2.** Logan Lagoons

In these trials we appreciate the good buffering capacity of the algae (pH of about 8) and of the microorganisms in the vessel. These were able to keep the pH neutrality (around 7) until cheese waste (pH of about 4) quantity of 70%. In addition, the cheese waste was rapidly fermentable because of its composition with simple molecules of sugars, fats and proteins. In fact, with a large input of this substrate, in a system with a well-established microbial pathway, biogas production was very rapid with peaks corresponding to the biomass loadings. In contrast, increasing the amount of algae, the anaerobic digestion process was more constant, but with lower production of biogas (Hansen and Hansen, 2002; Cline et al., 2012; Dustin et al., 2012).

In the last month, we tried to use the two small IBR vessels in series, the first one for the hydrogen fermentation of cheese waste and the second one for the anaerobic digestion of the first tank effluent.

It is known that acidogenesis produce small amount of hydrogen during the anaerobic digestion process. This secondary production is favorite by the acid

pH but is inhibited by the methane production that increase the pH to the neutrality (Chen et al., 2001).

In order to obtain the hydrogen production it is necessary to keep the pH in the range of 3-5 (Chen et al., 2002) and to increase the HRT from 3 days to 6 hours when the pH value ranges to 3 to 5 (Chen et al., 2001).

Therefore, the hydrogen fermentative bacteria can produce H<sub>2</sub> using a variety of carbon sources as a substrate. Moreover, these microorganisms produce valuable metabolites such as butyric, lactic and acetic acids as by-product that result an optimum substrate for biogas anaerobic digestion (Nath and Das, 2004).

In our tests additives were not necessary for the acid enrichment, thanks to the low pH value of the cheese waste. In fact, we started the trials by powering the 60 liters vessel with 30 liters of cheese waste in order to overwhelm the buffering capacity of the substrates in digestion, while keeping the active microorganisms in the remaining 30 liters. When the pH achieved values around 4 we started powering 2 liters per hour of cheese waste with an HRT of 2.5 days.

The results were not completed when I had to come back in Italy, but I know that the hydrogen(H<sub>2</sub>) production was good with peaks of 42% in the gases mixture.

In addition, every week we have taken samples of raw materials, influent, digestate, biogas and hydrogen gas mixture to carry out the laboratory analysis. In particular, we have determined the humidity by using a dry heater, ammonia (NH<sub>4</sub><sup>+</sup>) content and chemical oxygen demand trough a spectrophotometer technique. Instead, the composition of biogas and hydrogen content were evaluated by using a Gas Chromatographer.



## 2. The Irish Experience

### 2.1 Aim of the stage

From the 2<sup>nd</sup> March to the 2<sup>nd</sup> April of 2012 I attended an IELTS (International English Language Testing System) English course at the Language Centre of the University College Cork (UCC). In the same period I collaborate with Dr James D. Browne, PhD. He is the responsible of the Biogas Laboratory at the Environmental Research Institute of the UCC.

During the stage in this laboratory I was involved in research activities with an experimental two stages Upflow Anaerobic Sludge Blanket Digestion (UASB) reactor.

### 2.2 The UASB reactor

This kind of UASB reactor differs from other types because the plant is split in two separate parts (Figure2.2.1) in order to improve the efficiency of the digestion of solid biomass (Browne et al., 2013).



**Figure 2.2.1.** Two stage UASB reactor. On the left hydrolysis part, on the right methanogenesis part

The first part consists of six batch vessels where the hydrolysis and part of the acidogenesis reactions occur, while the acidogenesis and the methane production reactions occurs in the second part.

All the tanks are thermostated. In the first stage, the solid biomass is placed in a steel basket, one for each tank, above the inert and draining material (in this case of stones). The granular leachate is partially sent to the second stage of the process, while the remaining part is recirculated and sprayed above the solid biomass in digestion. The liquid recirculation promotes the microbial growth and the further percolation of granular leachate. In this stage the pH is kept around 5 while in the other the pH is kept around 7. In the second stage the tank is powered with only liquid granular phase of the original biomass, in fact classic UASB reactor are used almost only for wastewater treatment.

Figure 2.2.2 illustrate the control panel of the plant. The panel shows temperature, pH and biogas production of the two stages, in addition it allow for the speed setup of the recirculation pump and of the powered UASB pump.

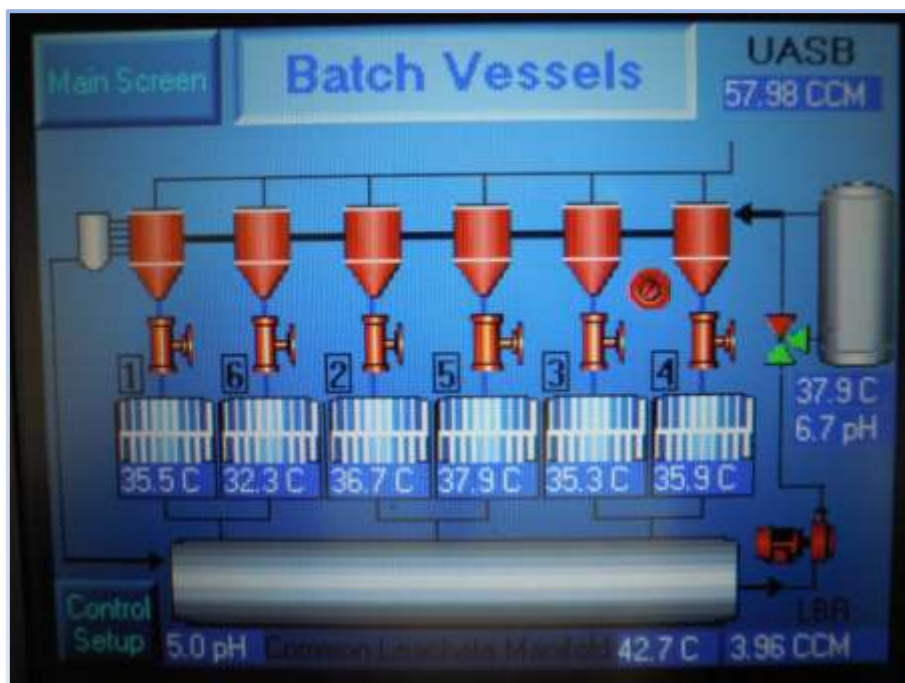

Figure 2.2.2. Control and setup panel

### 2.3 The experimental activities

In the month that I stayed in Cork, Dr James D. Browne and I worked to the phases of powering of the batch systems with restaurant waste and monitoring of the functional parameters such as temperature, pH, biogas production and powering pump speed (Browne and Murphy, 2013).

Therefore we collected samples to determinate volatile organic acids and the alkaline buffer capacity of the granular phase by using the basic titration method (Figure 2.3.1) and ammonia content and chemical oxygen demand by using a spectrophotometer (Figure2.3.2). In addition I carried out the evaluation of the methane content in the biogas by using a portable gas analyzer.



**Figure 2.3.1.** Titration method



**Figure 2.3.2.** Preparation sample for COD and  $\text{NH}_4^+$  determination

## **Chapter 3: Experimental Results**

## **Section I: The Biogas**

### **“Location and sizing of an anaerobic digestion plant for biogas production in south-eastern Sicily<sup>1</sup>”**

---

<sup>1</sup> Restuccia A., Giurdanella A., Failla S., *Localizzazione e dimensionamento di un impianto di digestione anaerobica per la produzione di biogas nella Sicilia sud-orientale*. Proceedings of the National Meeting “Attualità della ricerca nel settore delle energie rinnovabili da biomassa”. ISBN 978-88-906186-1-1, pp.318-325, Ancona, 16-17 dicembre 2010.

## 1. Introduction

The Biogas production, besides contributing to the electricity production by renewable sources, could represent an opportunity for the use and valorization of the livestock manure and also of the agro-industrial waste in the environmental respect. Moreover, anaerobic digestion plants allow the diversification of the farmers revenue, as called for in the intervention lines laid down by the PAC and implemented through by the PSR 2007-2013. Nowadays, the cogenerator combustion is the biogas application mainly used for anaerobic digestion plant. Thanks to the government contribution for the energy sold to electric service provider (GSE), the plant can generate revenue for the farmer that can reach 800 € per kW installed (Devenuto and Regazzoni, 2008). However, it is known that at least 3-7 years are needed to get the payback of the investment (EPA, 2002).

The aim of the research is to assess the available resources to be allocated for biogas production by bio-fermentation process and to sizing an anaerobic digestion plant considering the biomass present in a south-eastern Sicily area.

The feasibility analysis has been carried out in the province of Ragusa, mainly among the towns of Modica, Ragusa and Ispica. This area is one of the most important for number of farms and agro-food farms that can guarantee the daily production of residues necessary for the anaerobic digestion process.

It is known that you can get excellent results from the anaerobic digestion of livestock manure together with corn, sorghum or wheat silage. However, recent studies (Araldi et al., 2009; Dinuccio et al., 2009) have shown that even vegetable residues and agro-industrial wastes may determine a good biogas production, such as tomato hulls, corn scrap, barley straw or grape marc. These biomasses, thanks to their high availability on national scale, could contribute to the production of more than 2,000 GWh/year of electricity (Dinuccio et al., 2009).

Forty farms were surveyed to check the biomass amount and the period of availability. The farms are located within a radius of about 25 km from the farm where the biogas plant should be realized. In order to benefit by the maximum incentive rate (D.L. n.99/2009) for short chain biomass plants, this distance is much lower than the fixed limit of 70 km according to the law (D.M 20 November 2007).

## **2. Methodology**

### **2.1 The area surveyed**

The Ragusa province consists of 12 municipal districts with a total surface of 1,614 km<sup>2</sup> and about 316 thousand inhabitants.

Two agriculture-zootechnical macro-areas are distinguishable. The highland area is characterized by cereal and cereal-zootechnical farms, while the coastal area is characterized by numerous nurseries, vegetables and flowers farms both in greenhouse and in open field.

The agriculture in Ragusa province consist of about 25 thousands farms with a total SAU of about 100 thousands hectares. The vegetable farms are about 5 thousands, both in greenhouse and open field. The zootechnical farms are instead more than 2 thousands, with 1 thousand and 700 hundred of cattle-breeding (about 40 heads of cattle per farm).

In the total Ragusa province about 70 thousands of cows are present and the total area milk production is about 1,500,000 t/year (according our elaboration of ISTAT data, Agriculture Census 2000).

Every year 30,000 m<sup>3</sup> of livestock manure and 1,300,000 t of cheese whey are produced.

For the survey, we choose an area that include the municipal district of Ragusa, Modica, Ispica and Scicli (Figure 2.1.1) because of the higher concentration of zootechnical farms than the other areas. In this way the hypothetical transport distance of the biomass is less than 30 km.



Figure 2.1.1. Surveyed area

## 2.2 Detecting of farms and biomass availability

Forty farms were surveyed: 29 cereal-zootechnical farms, 3 fruit and vegetables consortia, 3 flowers nurseries, 2 oil mills, 2 milk collection consortia and 1 poultry farm.

The aim to involve the agro-food farms is linked to the opportunity to increase the value of the huge amount of wastes and by-products produced during raw materials processing.

This wastes can be classified as "by-products" according to the 183 article (comma 1, letter n) of D. Lgs. 4/08. This new "by-product" definition allow to use these wastes for the anaerobic digestion rather than to classify them as wastes (CRPA, 2008).

A data collection sheet was compiled for each farm, in order to obtain a comprehensive and detailed analysis of the biomass produced in the study area.

Types and produced quantities of biomass were identified by elaboration of the data sheets: livestock effluent (cattle manure and slurry and poultry manure), waste from vegetables processing (zucchini, watermelon, carrot, tomato, artichoke, melon, pepper, beet, potato, etc.), cheese whey, olive pomace, green waste of ornamental plants and nursery seedlings.

The 29 cereal-zootechnical farms were characterized by cattle farming in free stabling and considerable use of grazing. These farms were extended over



2,068 ha with a total of 3,935 animals, about 135 head of cattle/farm. The amount of manure was 18,216 m<sup>3</sup>/year and the slurry was 9,600 m<sup>3</sup>/year; both amounts corresponded respectively to about 4,554 and 9,312 tons per year.

Twenty-two of the 29 farms produced milk for consortia present in the area, 5 had a dairy farm to produce typical cheeses (Caciocavallo Ragusano and Provola Ragusana) and ricotta, the last 2 farms bred beef cattle. The total amount of produced milk in the 27 “milk farms” was 16,604 t/year, instead the 5 farms produced 1,134 t/year of whey from cheeses processing.

The two consortia of collection and processing milk worked 16,680 t of milk every year, producing 11,280 t/year of cheese whey.

The three fruit and vegetables consortia covered an area of 1,362 ha and produced 11,800 t/year of vegetables wastes from greenhouse and open field crops.

The three flowers nurseries, covering an area of 25.5 ha, produced 5,023 m<sup>3</sup>/year of wastes which correspond to 2,130 t/year of available green biomass.

The two oil mills worked 1,300 t of olives every year for producing 224 t/year of vegetable oil and 580 t/year of olive pomace.

The poultry farm owned 120,000 laying hens which produced about 3 million of eggs every year and 4,320 m<sup>3</sup> of poultry manure (about 1,080 tons).

The amounts of biomass produced by the forty considered farms are shown in the table 2.2.1.

## Section I: The Biogas

**Table 2.2.1.** Livestock manure, wastes and agro business by-products

Biomass type	Fresh amount		
	t/year	t/month	t/day
<b>- constant availability:</b>			
Cattle slurry	9,312	776	25.8
Cattle manure	4,554	379	12.6
Poultry manure	1,080	90	3.0
Cheese whey	12,414	1,034	34.5
<b>TOTAL</b>	<b>27,360</b>	<b>2,279</b>	<b>75.9</b>
<b>- periodic availability (from – to):</b>			
Vegetable wastes:			
Open field (March – July)	6,630	1,326	44.2
greenhouse (October – July)	5,170	517	17.2
Olive pomace (October – December)	580	193	6.4
Green biomass:			
peak (September – October), (December – March)	1,494	249	8.3
Outside peak (April – July), (October – November)	636	106	3.5
<b>TOTAL</b>	<b>14,510</b>		
<b>YEAR TOTAL</b>	<b>41,870</b>		

As it is shown in the table 2.2.1, some biomass have a constant availability because they are available during all the year. Other have a periodic availability because they are available only in some months in relation to the production activities from which they come from.

Some available biomasses in the area considered, such as livestock manure and cheese whey, are produced constantly during all the year. For this reason they represent an excellent basis for the anaerobic digestion process which needs to be continuously supplied with daily frequency. Other seasonally produced biomasses, such as olive pomace, are difficult to preserve because of rancidity phenomena. The olive pomace productions is concentrated in the months of October, November and December and for these reasons they are available only in some periods of the year.

The wastes obtained from vegetables and flowers nurseries (green biomass) are inhomogeneous in the different production months as it is shown in the figure 2.2.1.

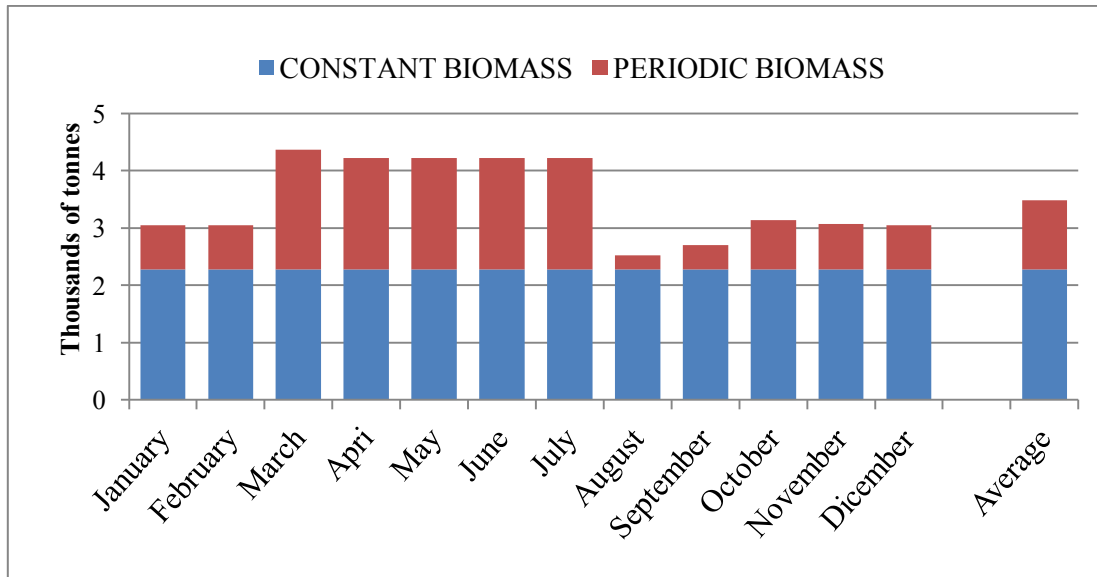

Figure 2.2.1 Year distribution of biomass production

In summary, the amount of biomass available throughout the year show a trend not constant with a minimum amount of 2,500 t in August and a maximum one of 4,500 in March, while the average availability would be about 3,500 t of biomass (Figure 2.2.1).

### 2.3 Biogas plant location

The farm where the plant could be realized should have four fundamental requirements:

- ✚ centrality than the other farms
- ✚ higher amount of cattle
- ✚ great superficial extension
- ✚ suitable viability for biomass supplying.

The farm with all of these characteristics and thus suitable for this purpose was situated in Modica. It was a cereal-zootechnical farm and its main product was milk to sell at the collection station. The farm covered a total area of 107 ha; 45 ha of these were cultivated to produce hay, 50 ha for grazing and 12 ha to produce wheat for cattle feeding. In total there were 180 head of cattle (value above the average of the surveyed farms), reared in free stall on litter,



### 3. Results and discussions

#### 3.1 Productivity of biomass energy and sizing of CHP unit

The estimate of the biogas obtainable from the biomass is necessary to size the power of the hypothetical plant.

For this purpose the yields of biogas of available biomass with medium content of 55% of methane were considered. In table 3.1.1 the most used and listed in bibliography conversion parameters of biomass in biogas are shown.

**Table 3.1.1.** Gas yield of the biomass

Biomass	Yield in biogas at 55% of CH <sub>4</sub>
Cattle slurry (Piccinini et al., 2008)	29
Cattle manure (Piccinini et al., 2008)	70
Poultry manure* (Chiumenti et al., 2007)	128
Green biomass (Dinuccio et al., 2009)	17
Cheese whey (Dinuccio et al., 2009)	16
Olive pomace (Pantaleo et al., 2009)	145
Vegetables wastes* (Zullo et al., 2005; Giraldi et al., 2007)	20

m<sup>3</sup> biogas/t of fresh product

\*Our elaboration medium value

The cubic meters of producible biogas every month (Figure 3.1.1) are obtained by multiplying the yields in biogas of each available biomass (Table 3.1.1) with the corresponding amounts (Table 2.2.1).

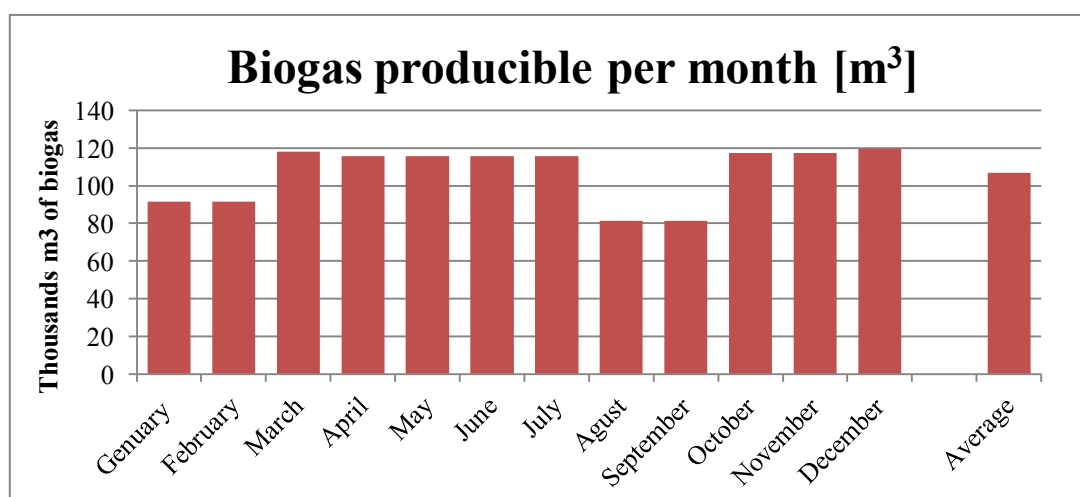

**Figure 3.1.1.** Monthly production of biogas

It appears that the trend of biogas production (Figure 3.1.1) is linear with the monthly availability of the biomass in the surveyed farms as shown in the figure 2.2.1. The lower peak is in August with 81,000 m<sup>3</sup> of biogas, while the monthly average is about 107,000 m<sup>3</sup>. It is important to underline that just in 4 months of the year the biogas production is lower than the average.

The higher peak is in December with 119,700 m<sup>3</sup> of biogas, even if the availability of biomass is maximum in March. This is due to the fact that the lower availability of biomass in October, November and December is compensated by highest yield in biogas of the olive pomace than others considered biomass.

Knowing the amounts of biogas obtained from considered biomass, it is possible to traced back to the electric energy produced by combustion of the biogas in an internal combustion cogeneration engine, considering two important process parameters. The first one is the Lower Heating Value (LHV) of biogas at 55% of CH<sub>4</sub> , which is 5.1 kWh/Nm<sup>3</sup>. The second parameter is the electrical efficiency of the cogenerator, that in this case is considered equal to 32% because of the installed power that results lower than 500 kWe of peak.

Electric energy month production, shown in the figure 3.1.2, is obtained multiplying the yields in biogas with the LHV and the efficiency of the co generator.

This production is directly proportional with the biogas production, so the monthly trend will be directly proportional both to the monthly availability of biomass and to the biogas production, respectively shown in the figures 2.2.1 and 3.1.1.

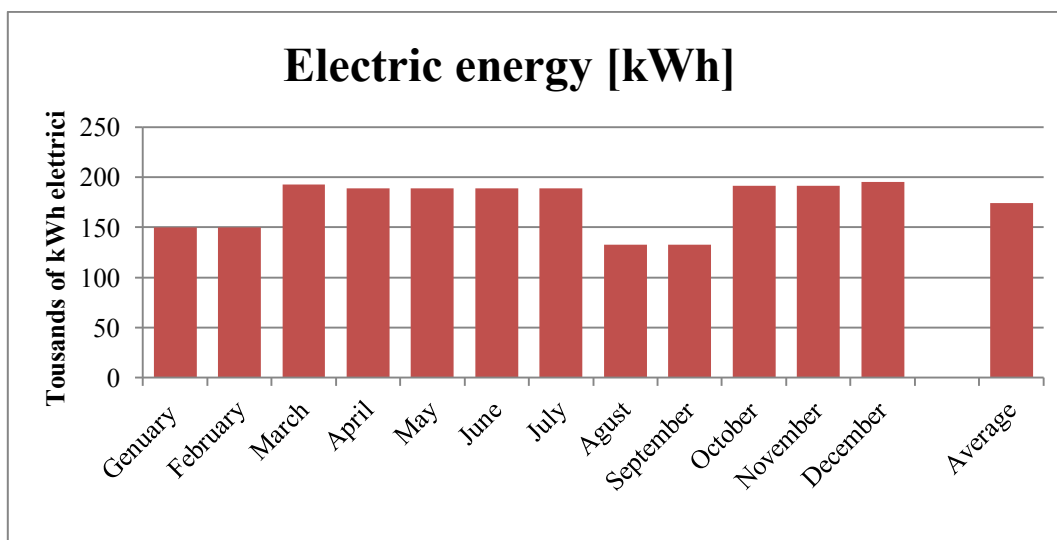

Figure 3.1.2. Monthly production of electric energy

As shown for the biogas, even in this case, the maximum peak of production is in December with about 195 MWh, while the minimum production is in August with only 133 MWh. The monthly average is about 174 MWh.

Considering about 7,500 working hours per year, the power of the co-generator is easily calculable starting from the theoretical biogas production, as shown in Table 3.1.1.

Table 3.1.1. Productivity of censured biomass

PARAMETER	BIOMASS								
	Cattle manure	Cattle slurry	Poultry manure	CheeseWhey	Partial	Vegetables wastes	Green biomass	Olive pomace	Total
Availability t/year	4,554	9,312	1,080	12,414	27,360	11,800	2,130	580	41,870
Gas yield m <sup>3</sup> biogas/t fresh	70	29	128	16		20	17	145	
Obtainable Biogas m <sup>3</sup> /year	318,780	270,048	138,240	198,624	925,692	236,000	36,210	84,100	1,282,002
LCV Biogas kWh/Nm <sup>3</sup>	51								
Potential Energy kWh/year	1,625,778	1,377,245	705,024	1,012,982	4,721,029	1,203,600	184,671	428,910	6,538,210
CHP electric efficiency	32%								
Producible E.E. kWh/year	520,249	440,718	225,608	324,154	1,510,729	385,152	59,095	137,251	2,092,227
Annual operating hours	7,500								
Installable Power kWp	69	59	30	43	201	51	8	18	279

In this table, two different hypothetical anaerobic digestion plants have been considered. The first is called “Partial” because it is powered with only biomass available every month; the second is called “Total” because it uses all the available biomass in the study area both that constant and periodic.

The hypothesis “Partial” is able to produce 925,692 m<sup>3</sup>/year of biogas from the digestion of 27,360 t of biomass and the electric energy produced is more than 1.5 TWh/year. In this case, the theoretical CHP system could have a nominal power of 200 kWp. In the “Total” hypothesis 1,282,002 m<sup>3</sup>/year of biogas are producible using 41,870 t of biomass. The obtainable electricity is about 6.5 TWh/year and in this case the power could be of 297 kWp.

Considering a family energetic demand of about 3,000 kWh/year, the “Partial” hypothesis could satisfy the energetic demand of 500 families, while the “Total” one could achieve 700 families as well as the same farms considered in this study.

The realization of an anaerobic digestion plant with only biomass always available throughout the year could allow to achieve good results in terms of energy production. Nevertheless, the integration of livestock manure and cheese whey with biomass available only in limited periods of the year seems to be the best hypothesis for the production of electrical energy and for the use of biomass otherwise considered as waste.

### **3.2 Profitability of the plant**

Most of the plants, except for simple ones type (done with plastic material for covering wastewater lagoons or animal sewage stock tanks without heating and stirring) have an interval of cost investment from 250 to 700 €/m<sup>3</sup> for the anaerobic digester and from 2,500 to 7,500 €/kWh for the co-generator (Piccinini et al., 2008).

If we consider existent plants of about 300 kWel, an average unit cost of 3,500 €/kW is enough suitable. Knowing this value the estimated cost of a



280 kW plant is equal to € 980,000. In detail, in table 3.2.1, costs and proceeds are shown. They are the most common used to produce an annual average cash flow of the plant.

**Table 3.2.1.** Economy of the investment

<b>Installed power</b>	<b>kW</b>	<b>280</b>
Electricity	kWh/year	2,075,204
Net Electricity (total – 10% of re-employments)	kWh/year	1,867,684
<b>Investment cost</b>	<b>€</b>	<b>980,000</b>
Recovery of capital (12 years con i=5%)	€/year	<b>107,800</b>
Cost of biomass transport (5 €/t)	€/year	206,275
Cost of maintenance (15 €/MWh)	€/year	31,125
Cost of labor (2% invested capital)	€/year	19,600
Cost of assurance (0,3% invested capital)	€/year	2,940
<b>Total costs</b>	<b>€/year</b>	<b>259,940</b>
Selling of electrical energy (0,28 €/kWh)	€/year	581,057
<b>Net proceeds (Selling EE - Costs – Recovery of Capital)</b>	<b>€/year</b>	<b>213,317</b>

The profitability of the plant has been verified exclusively on the all-inclusive tariff of 0,28 €/kWh for the electrical energy produced in plant working in short chain. This is due to the fact that the distribution and selling of the generated thermic energy is not linked to the entrepreneur will and for this reason difficult to evaluate before (ex-ante). Moreover, possible proceeds, derived from the disposal of by-products that could represent a cost for other farms, have not been evaluated.

It is possible to suppose that the annual net proceeds is about € 213.317, with the possibility to reintegrate the employed capital in the first 12 year of the plant operation instead of 15 year as wanted by guaranteed all-inclusive tariff of national incentive on renewable energy.

However, it should be noted that these considerations are valid in relation to the period when the work was written, but they should be reviewed in the light of the new tariff.

#### 4. Conclusions

The survey conducted in Ragusa province was useful to size a co-generator of 280 kWe of peak, powered with the biogas produced by an anaerobic digestion plant. The plant could work all the year using 27000 t or 42000 t respectively only constant biomass or constant with together periodic biomass. Nevertheless this seasonality of production can be overcome with the ensiling technique which would allow a better use of the biomass during all the year.

The livestock manure, cheese whey, wastes and agro-food by-products were intercepted in 40 farms which are in a radius of 25 km from the hypothetical plant. This could create employment near the production area and not so high pollution due to the biomass transport.

The interviewed entrepreneurs were much interested about the realization of a consortial anaerobic digestion plant in that area. For this reason, it might be useful to involve a greater number of farms (rich in wastes and by-products) to size a bigger plant

In addition, other poles of energy production can be realized in other areas of the Ragusa territory and in Sicily in general, such as that considered in this study.

The possibility to reduce the use of carbon fossil by the use of renewable energy is one of the multiples positive results of the anaerobic digestion plant. Another benefit is to increase the value of livestock effluent and agro-industrial by-products, the use of which imply high costs of disposal. Moreover, the digestate of the plant could represent a good fertilizer for cultivated crops.

Finally, the thermal energy produced by the co-generator is another positive aspect. It is estimated that per each electrical kWh it is possible to obtain an available thermal kWh. This energy could be used by the same farms that confer biomass, for example dairy farms and fruit and vegetable consortia, which need thermal energy all the year.

It is difficult to create the district heating because of the distance between the urban centre and the plant. Moreover the realization of a district heating needs of specific infrastructure that the public administration should build through specific measures of intervention that are often non-existent.

## **Section II: The biodiesel**

**“Biodiesel production from unconventional oil  
bearing crops”**

## 1. Introduction

The main common species cultivated for biodiesel production are sunflower, rapeseed and soybean. The cultivation of the fields is not a problem, because they are species historically cultivated for other reason such as vegetable oil for human nutrition. The main problems are, instead, related to the farming extraction and transesterification, that often reduce the amount of oil and the biodiesel quality obtainable from them. In fact, the work capacity of the small farming screw presses are between 15 and 50 kg/h of seed worked and they could leave about 10% of oil in the press cake. In the other hand, the press cake could be used in a biomass boiler to obtain thermal energy (Bentini and Zucchelli, 2007).

Screw pressing is a simple, flexible, safe and continuous mechanical pressing procedure. It don't need of chemicals solvent and is possible to build really small machines. However, working with warming temperature of 50°C, the optimum moisture content in rapeseed for oil extraction is 7.5% (Sigh and Bargale, 2000).

Other Authors report that, although the oil content in linseed is ranged between 36-40%, the oil extraction yield who they obtained is between 19% and 32%. They demonstrate also that the yield is related to the number of presses used (Kasote et al., 2012).

To be considered sustainable, the production of biodiesel (cultivation, extraction and trans- esterification) should involve lower energy consumption than those obtainable with its use. For these reasons, it is necessary to optimize the use of machinery and related cultural practices in marginal agricultural context where oilseed crops can be grown for energy purposes and to identify cultivars well adapted for growing in less-favoured areas.

Moreover, the evaluation of the energy balance, defined as the ratio between the energy content of combustible (Output) and the energy absorbed by the production process (Input) is strategic to establish the energy sustainability of a biofuel. In this respect it is useful to point out that the assessment of the

Input may result in different outcomes depending on the methodology adopted.

From energy audits conducted on rapeseed and sunflower it shows that to the phases of agricultural production and transesterification are attributed, in almost equal parts, about 76% of the total energy used and approximately 15 MJ/kg of biodiesel produced. Considering a calorific value of biodiesel equal to 37.3 MJ/kg, approximately 2.5 units of energy (biodiesel) per unit of energy consumed were obtained (Riva et al. 2008).

## 2. Cultivated Species

In this context, we choice to cultivate two uncommonly oil bearing crops such as *Linum usitatissimum* L. and *Camelina sativa* L. derive from the scope to support the development of agro-energy in Sicily. These species with high oil content, cultivated for energy purposes, are able to adapt to soil and climatic unfavorable conditions, enhancing thus the marginal areas or abandoned areas of agricultural land. For these reasons, it could be of great importance to focus on crops adapted to marginal land and non-irrigated or historically used for other crops and now being abandoned.

### 2.1. *Linum usitatissimum* L.

The cultivars of linseed or flax (*Linum usitatissimum* L.) have been widely used in Sicily in the past years, recording a yield per hectare almost double the national average (Crescini, 1969; Rivoira, 2001).

Historically, linseed was used both for fiber and oil production. During the second world war period (1935-1940), in Italy were cultivated about 15,000 ha. The maximum expansion of this crop was achieved between 1950 and 1970 when about



50,000 ha were cultivated. However, linseed production decreased and in 1986 the cultivated lands were only about 100 ha (Bacci et al , 2007).

The linseed is a plant that appertains to the Liliaceae family. It is an herbaceous plant with a taproot, thin and little branched, but nevertheless it's able to take full advantage of the soil water resources. The leaves are glaucous green, slender lanceolate 20–40 mm long and 3 mm broad. It is an upright annual plant and the height is closely related to the cultivation environment,



the seeding density and the fertilizing, usually around 1m with stem diameter of 1-2 mm. The flowers are pure pale blue of 15-25 mm diameter. They have five petals and five sepals. The flowering stage lasts, depending on environmental conditions, from 10 to 20 days. As result of the fertilization, from flower originates a dry-capsule 5–9 mm diameter with five lodges, each containing two seeds. The ripe capsules are mostly indehiscent, at least in the cultivated varieties. The seed is smooth, flat, shiny, usually reddish-brown in colour and 4-7 mm long (Bacci et al., 2007). It is small and lightweight, the thousand seeds weight could be in a range between 3 and 15 g (Crescini, 1969) and for most of commonly variety cultivated between 4 and 10 g (Bacci et al, 2007; Rivoira, 2001). The oil content in the seeds can achieve values around 35% (Rivoira, 2001).

## 2.2. *Camelina sativa* L.

Nowadays *Camelina sativa* L. is a common weed in industrial herbaceous crops in Europe, known as false flax or gold of pleasure (Zubr, 1996; Ehrensing and Guy, 2008). This species is native of the north-eastern Europe where it was historically cultivated for the oil production both for medical and oil lamp use. Like linseed, camelina was also cultivated during the second world war period and its subsequent decline was accelerated by farm subsidy programs that favored the major commodity grain and oilseed crops (Ehrensing and Guy, 2008).





*Camelina sativa* L. together with other oilseed crops, have garnered interest as potential sources of biodiesel. *C. sativa* has attracted interest as an oil crop because of its ability to grow in various climatic conditions, low nutrient requirements and resistance to disease and pests (Zubr, 1996; Gugel and Falk, 2006; Francis and Warwick, 2009) and also because of its high content in omega-3 fatty acids (Ehrensing and Guy, 2008).

The Camelina is a plant that appertains to the Brassicaceae family. In favorable conditions of temperature and humidity, it germinates in a few days.



The initial underground part consists in a conical root, while the above ground part is a rosette of leaves. Subsequent, an erect stalk with numerous leaves starts from the rosette. The plants grow 30 to 90 cm tall and have branched stems that become woody when mature. The flowering produce numerous four-petaled flowers that are pale yellow in colour and 5-7 mm in diameter. As

result of the fertilization, the flower originates a small (4-5 mm) seed capsule that resemble the linseed bolls. The capsule contain about 15 oval-shaped yellow seeds. Camelina produces no dormant seeds, the size is quite small and depend on variety and environment growth conditions. The thousand seeds weight could be in a range between 0.8 and 2 g. Seeds have good oil content that is reported between 29 and 46% and it is higher in winter varieties than the summer one (Zubr, 1996; Ehrensing and Guy, 2008).

### 3. Material e methods

#### 3.1. Experimental field

The experimental field was carried out in the province of Siracusa in south-eastern Sicily (36°49'02.61N - 15°05'33.81E); it covers an area of about 15,000 m<sup>2</sup> with a maximum width of about 80 m and length of about 186 m. For this experiment, two non-irrigated plots were realised, one for each species concerned; each plot covers an area of 5,000 m<sup>2</sup> and has a size of 80 m × 62 m (**Figure 3.1.1 and 3.1.2**). To avoid contamination between different species sown and to facilitate the mechanization of cultural practices, a buffer zones of 10 m between the plots and the edge of the area, and between the parcels have been left.

The field is flat, rectangular in shape, oriented NW-SE and has an altitude of 15 m above sea level. The soil is compact, with lightweight skeleton presence and weaving of medium consistency.

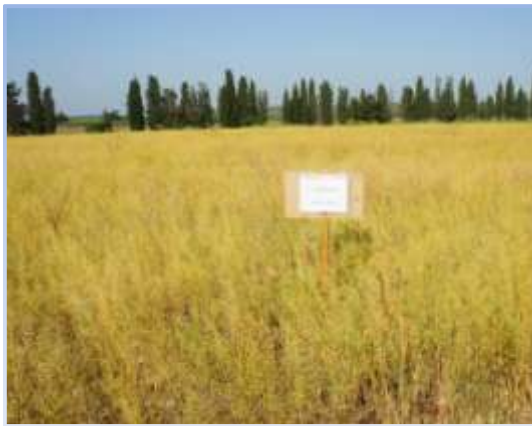

**Figure 3.1.1.** Camelina's plot



**Figure 3.1.2.** Linseed's plot

#### 3.1.1. The cultural practices and the machines

Due to the small size of oilseed crops, the tillage were carried out by performing a through preparation of the seed bed. At the beginning of December, a preliminary shredding of existing weed was carried out. The

tillage was performed with a shredder having knives on a horizontal rotor, driven by the power take-off, of a width of 2.70 m and mass of 1,130 kg.

Subsequently, to break the compact layer of the surface soil and aerate it a harrowing was carried out. The farm machine used is a cultivator having 9 chisel plow shovels arranged in two rows, of a width of 2.25 m and mass of 500 kg. For the refinement of clods created in the previous tillage a hoeing was conducted. This tillage was carried out with a rotary tiller of a width of 2.05 m and mass of 450 kg.

Sowing and fertilization took place simultaneously in the third decade of December, by distributing 320 kg/ha of complex mineral fertilizer (NP 25-15) and 39 kg/ha of linseed and 4.2 kg/ha of *C. sativa* seed.

For shredding, harrowing, hoeing, the farm machines were connected to a 4 WD tractor of 74 kW and mass of 3,500 kg.

The seeder used for *L. usitatissimum* is universal type with mechanical distribution (Figure 3.1.1.1), 19 distributors and mass of 740 kg, double hopper for seed and fertilizer. The width is 2.50 m with adjustable spacing between the distributors (the minimum is 13 cm). In order to obtain a distance between the rows equal to 26 cm the distributors were used alternatively, by closing 9 of them. Because of the small size of the seed, the depth of deposition was maintained between 0.5 and 1 cm. The seeder was connected to a 4WD tractor of 74.5 kW and mass of 3,500 kg.

The seeder used for seeds of *C. sativa* is precision type with pneumatic distribution (Figure 3.1.1.2). It has three binate rows of distributors with a distance of 7 cm between rows and 40 cm between the binate rows, so as to obtain a working width of the machine equal to 1.60 m. In particular, the distance between rows was equal to 1.4 cm and the depth of sowing 0.5 cm because of the very small size of the seed. The distance between the binate rows was equal to 40 cm. The seeder was connected to a 2WD tractor of 44 kW.



Figure 3.1.1.1. Mechanical seeder



Figure 3.1.1.2. Pneumatic seeder

After sowing, the rolling to make homogeneous the surface of the soil and a pre-emergence herbicide treatment were carried out. Doses of 1 L/ha of product with active ingredient "Linurom" in concentrations of 45 g/L, for linseed, and doses of 1 L/ha of product with active ingredient "Metazachlor" pure in concentrations of 43.5 g/L for camelina were used. The volumes distributed were respectively 350 L/ha for linseed and 175 L/ha for camelina crop; these volumes correspond to the minimum recommended doses.

The rolling was performed with smooth roller having a width of 2.4 m and mass of 1,000 kg (Figure 3.1.1.3), connected to a 4WD of 78 kW and mass of 2,540 kg.

The pre-emergence weed control was carried out by a bar sprayer 10 m wide and flat spray tips (Figure 3.1.1.4). The pressure during the treatment was 20 bar. The sprayer was connected to a 4WD tractor of 52 kW and mass of 3,200 kg.



Figure 3.1.1.3. Smooth roller



Figure 3.1.1.4. Bar sprayer

During the growing season of the crop, periodic inspections of the experimental field were carried out which did not reveal the need to conduct additional cultural practices such as fertilization and weed control.

The harvesting of the crops was carried out in the first ten days of June, upon the completion of the seeds maturation, which was tested by sampling in the experimental field.

A combine harvester (Figure 3.1.1.5) was used for the harvesting, commonly used for herbaceous crops, of 167 kW, mass of 10,400 kg and cutter bar of 5 m, by properly adjusting the speed of the awner and the opening of the threshing drum. In detail, given the small size of the seeds and not excessive resistance to detachment from the capsule by the same, the speed of rotation of the awner was set relatively low, amounting to about 850 rpm for *L. usitatissimum* and 650 rpm for *C. sativa*. The opening of the threshing drum was set of 6 mm anteriorly and 2 mm posteriorly for *L. usitatissimum* and 12 mm anteriorly and 3 mm posteriorly for *C. sativa*.



**Figure 3.1.1.5.** Combine harvester

### 3.1.2. The methodology of field tests

In order to calculate the effective working capacities [ha/h] and then the time units of utilization [h/ha] for each cultural practice were recorded by adopting a standardized methodology (CIOSTA Comité International d'Organisation Scientifique du Travail en Agriculture) The methodology provides time measurements of working time in the field, together with the measurement of the surfaces worked, in order to determine the following operating parameters: i) effectively work capacities ( $C_e$ ), ii) time unit of work ( $1/C_e$ ).

For each agricultural operation (tillage, fertilization, planting and weeding), the average values of the efficiency time (TE), derived from observations made in the two plots, were determined. This is the time measured of actual work, in other words net of any wasters.

The effective working capacities ( $C_e$ ), linked to the technical and structural characteristics of the complex tractor-operating machine and environmental conditions (land, operator skill, etc..), was determined as:

where 0.36 is a conversion factor for the units of measurement,  $V_e$  is the average forward speed of the tractor-operating machine detected during the time TE,  $L_e$  is the effective working width (m), derived by dividing the total width of the area actually worked to the number of passes of the machine.

Before sowing, the seeders have been previously adjusted, in order to obtain the dose of sowing considered optimal and verify the uniformity of cross-seeding between the distributors.

Even the sprayers used in herbicide treatments were subjected to regulatory measures and verifying the proper operation.

The diesel fuel consumption was calculated through a direct measurement by using the "top-up" method on the field; furthermore they were verified through

the sizing of the power, necessary and sufficient, of the tractors used in the different cultural practices.

The consumption of lubricant oil was calculated by taking into account a specific consumption equal to 0,009 kg/kWh (Bodria et al., 2006; Bodria et al., 2013) and an engine load resulting from the ratio between the ideal power calculated through the sizing and the effective available power of the tractors used in the field.

### 3.2.Oil Extraction

The screw press plant used in the tests is located at the laboratories of the Grimaldi Foundation of University of Catania, in the town of Modica in the province of Ragusa. The prototype was built by an Italian company and has a nominal working capacity of 40 kg/h (**Figure 3.2.1**).

It consists of an electric motor of 3 kW at 230 V, a digital thermostat, a loading hopper of 20 liters capacity, a single head screw press, some settling tanks for extracted oil and a tank for oil storage. These last two components were not used for the tests since the pressed oil was conveyed through a steel channel directly into a stainless steel tank.

In particular, the head of the screw press (**Figure 3.2.2**) is constituted by a perforated cage inside which rotates a worm screw. This consists of two sections of different pitch and it is driven by the engine. The oil exits the perforated cage through holes of 3.7 mm in diameter while the press cake is extruded by passing through the bushing output placed at the end of the head. The machine is equipped with 5 different bushings of different diameters: 6-8-10-12-16 mm.



Figure 3.2.1. The screw press plant



Figure 3.2.2. Screw press head

The squeezing process with this prototype essentially consists in the following phases:

- ✚ Pre-heating of the machine and definition of the set point on the thermostat
- ✚ Manual filling of the hopper (half hopper) with seeds
- ✚ Regulating the rotation speed of the screw and choice of the bushing output
- ✚ Mechanical pressing of the seeds
- ✚ Leaking of oil and oilcake
- ✚ Passing of oil through the settling tanks to be filtered before the storage

### 3.2.1. Methodology of mechanical extraction of oil

For carrying out the tests 240 kg of linseeds and 240 kg of camelina seeds have been used. These seeds had been previously characterized in the laboratory. In particular, the following parameters were evaluated:



- ✚ Weight of a thousand seeds [g]
- ✚ Number of seeds per capsule (seed-case) [n.]
- ✚ Moisture content [%]
- ✚ Percentage of impurities [%].

Following the diagram of the process shown in figure 5.4.1, several surveys and adjustments were carried out before pressing the seeds. Regarding the surveys, these parameters were detected:

- ✚ Power absorbed by the electric heating resistor of the head [kW] at  $T_0$  -  $T_1$  -  $T_3$  -  $T_5$  -  $T_{10}$ , by means of an electricity meter;
- ✚ Operating temperature [°C] at  $T_0$  -  $T_1$  -  $T_3$  -  $T_5$  -  $T_{10}$ , by means of a thermocouple T type class 1;
- ✚ Rotation speed of the screw [rpm] by means of a tachometer.

The parameters considered for adjustments of the machine were:

- ✚ Operating temperature. The head screw press, without the use of heating, reached temperatures between 99 and 104°C. Not having a cooling system of the machine, and to standardize the operating temperature, it was decided to operate with a temperature set point of 105°C.
- ✚ Rotation speed of the screw. This parameter has been manually adjusted at maximum speed using a knob. This configuration corresponds to 60 rpm.
- ✚ Filling level of the hopper. In order to facilitate the descent of the seeds and to avoid compaction upstream of the hopper, the best loading level appeared to be about half the capacity of the container, since it made easy the manual shaking of the seeds loaded. The hopper was filled with approximately 4.5 kg of seed at a time.
- ✚ Bushing output. For the extraction of linseed oil the best result was obtained with the bushing of 10 mm, since larger diameters (12-16 mm) determined a very crumbly oilcake and a very dirty oil. The diameter of

8 mm has determined the block of the machine, probably due to the excessive compaction of oilcake. For these reasons it was decided not to test the bushing even closer to 8 mm.

Given the small size of the camelina seeds, only the bushings of 6-8-10 mm have been tried. With the bushing of 6 mm a high compression of the oilcake has determined a significant slowdown of the machine. The oil flowed fairly clean, but the work capacities were too low. With the bushing of 8 mm a good compression of the oilcake, a discrete oil cleanup and hourly capacity close to 30 kg/h were obtained. With the bushing of 10 mm a good work capacities and a decent oil cleanup were obtained, but an oilcake too "wet", or with an excessive residual content in oil. Because of these reasons, it was decided to operate with the bushing of 8 mm.

After making these adjustments, during the squeezing were detected the following parameters:

- ✚ Working time [h] by means of a chronometer and the consumed energy [kWh] by means of an electricity meter;
- ✚ Power absorbed [kW] by screw press during the work with the heating off (every 15 minutes) and the electrical voltage [V] (occasionally) by means of an electricity meter;
- ✚ Temperature [°C] of the oilcake (CH2) and of the oil pressed (CH2) by means of a thermocouple T type class 1 (every 45 minutes) and a dedicated software;
- ✚ Operating temperature [°C] of the head screw press, measured in two points (every 0.5 s) by means of a thermocouple T type class 1:
  1. In the vicinity of the electrical heating resistor, placed downstream of the extraction grid (CH1);
  2. In the upstream part of the extraction grid (CH1).

The instrument for the temperatures acquisition is equipped with a dedicated software that record the data and shows in real time a graphic (Figure 3.2.1.1) with the trend lines of the 5 channels (1 for each probe).

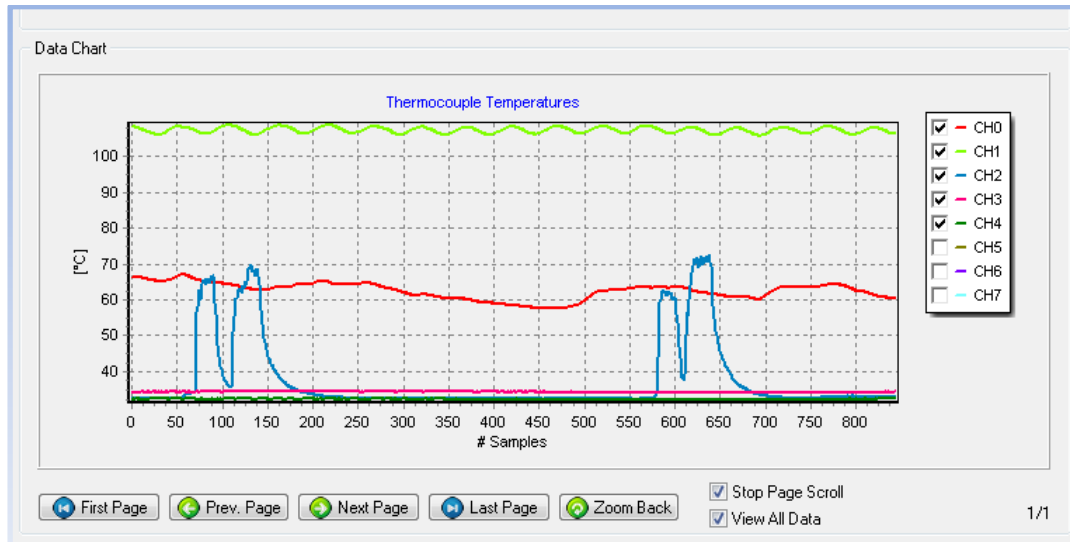

**Figure 3.2.1.1.** Real time graphic of the acquisition software.

The five colored lines represent the temperature probe used for this experiment. The light green (CH1) and the red lines (CH0) indicate the control temperature point positioned on the pressing head of the machine. CH1 was situated downstream of the extraction grid (near the electrical resistor), while CH0 was upstream the extraction grid. The turquoise line (CH2) is the probe used for occasionally testing of oil and press cake testing. The fuchsia line (CH3) is an inside probe necessary for the instrument monitoring. At last the dark green line (CH4) is the control room temperature.

During the squeezing, some samples of oil and press cake for each crop were taken for laboratory analysis. In particular, the moisture content and the Higher Heating Value (HHV) were analyzed following the standards method UNI EN 14774 1-3 and UNI EN 14919 by the CIRDER<sup>4</sup> laboratory.

The total quantities obtained of oil and press cake were transported to laboratory in order to verify their tests yields.

<sup>4</sup> Centro Interdipartimentale di Ricerca e Diffusione delle Energie Rinnovabili, Tuscia University, via Cavour 23, Orte (VT).

Two samples of oil, one of linseed and one of camelina were analyzed at the Agenzia delle Dogane<sup>5</sup> laboratory in order to determine the composition of the fatty acids.

### 3.3. Transesterification for biodiesel production

The chemical process of transesterification of vegetable oil for biodiesel with batch reactors was carried out at the laboratories of Mechanics and Hydraulics Department of Agri-food and Environmental Management Systems (DiGeSA). As extensively discussed in the Chapter 1 paragraph 2.2.1, the process consists in the transformation of an ester in an alkyl ester by reaction with an alcohol. As is known, during the process of esterification of vegetable oil, triglycerides react with methyl alcohol (more used than ethylic one) and in the presence of a basic catalyst. In the case study, was employed potassium hydroxide KOH because it is more or equally efficient as compared to other catalysts (Reza Shahbazi et al., 2012).

Methyl alcohol (CH<sub>3</sub>OH) reacts with fatty acids to form the mono-alkyl ester (or biodiesel) and raw glycerol. To complete the reaction from the stoichiometric point of view, a molar ratio between alcohol and triglyceride of 3:1 is required (Riva et al., 2008). However, since the reaction between the biolipid and alcohol is an equilibrium reaction and reversible, the methanol was added in molar ratios of 4.5:1 - 6:1 and 7.5:1 in order to shift the reaction towards the formation of esters and ensure a complete conversion.

As much importance is both the temperature and the agitation during the process, the reactions were carried out in three liters closed flasks with film on magnetic stirrer with hot plate (Figure 3.3.1).

In order to facilitate the separation of the glycerol from the biodiesel and to carry out the washing with water of biodiesel, separator funnels equipped with

---

<sup>5</sup> Agenzia delle Dogane, Chemical Laboratory, via Teatro Massimo 44, Catania (CT).

a tap for the elimination of substances to be separated were employed (Figure 3.3.2).



**Figure 3.3.1.** Three liters flask



**Figure 3.3.2.** Separator funnels

### **3.3.1. Methodology of transesterification of vegetable oil**

Following the diagram of the process, the oil obtained by squeezing was left to decant for about 1 month in the inox steel containers (Figure 3.3.1.1). Then it was filtered with a nylon filter having a mesh size of 5-10 micrometers (Figure 3.3.1.2) and soon after with appropriate filter paper.



**Figure 3.3.1.1.** Inox steel tanks



**Figure 3.3.1.2.** Nylon filter

The test protocol (Table 3.3.1.1) consists of three repetitions for each test, both for linseed oil and for camelina oil. The theses are a total of 18, which multiplied by three repetitions become 54 tests for each crop.

As indicated in Table 1, each test involves the use of 1 kg of oil to which there were added:

- ✚ three different amount of methanol  $\text{CH}_3\text{OH}$  (ratio mol:mol 4.5:1 - 6.0:1 - 7.5:1);
- ✚ three different amount of potassium hydroxide KOH (0.75% - 1.0% - 12.5%);
- ✚ at two different temperature (50° and 60°C).

**Section II: The Biodiesel**

**Table 3.3.1.1.** The test protocol of trans-esterification process for linseed and camelina oils

n.	Reactor	Oil	Methanol	KOH	Temperature	Time	Rotation
	Volume	mass	ratio				speed
	[ml]	[g]	[mol/mol]	[w/w]	[°C]	[min]	[rpm]
1	3000	1000	4.5:1	0.75%	50	60	750
2	3000	1000	6.0:1	0.75%	50	60	750
3	3000	1000	7.5:1	0.75%	50	60	750
4	3000	1000	4.5:1	1.00%	50	60	750
5	3000	1000	6.0:1	1.00%	50	60	750
6	3000	1000	7.5:1	1.00%	50	60	750
7	3000	1000	4.5:1	1.25%	50	60	750
8	3000	1000	6.0:1	1.25%	50	60	750
9	3000	1000	7.5:1	1.25%	50	60	750
10	3000	1000	4.5:1	0.75%	60	60	750
11	3000	1000	6.0:1	0.75%	60	60	750
12	3000	1000	7.5:1	0.75%	60	60	750
13	3000	1000	4.5:1	1.00%	60	60	750
14	3000	1000	6.0:1	1.00%	60	60	750
15	3000	1000	7.5:1	1.00%	60	60	750
16	3000	1000	4.5:1	1.25%	60	60	750
17	3000	1000	6.0:1	1.25%	60	60	750
18	3000	1000	7.5:1	1.25%	60	60	750

In the laboratory, each sample of oil of 1 kg was placed inside a 3 liter Erlenmeyer flask, and then pre-heated to a temperature of 50 or 60°C (Figure 3.3.1.3). Separately a mixture of methanol and potash in the established quantities for each test was prepared (Figure 3.3.1.4). This mixture, after being suitably stirred for a few minutes, was inserted into the flask where the oil was pre-heated. The whole was placed on the stirrer for 60 minutes and with a speed of rotation of 750 rpm.



Figure 3.3.1.3. Erlenmeyer reaction flasks



Figure 3.3.1.4. Reagents mixing process

After this time, the mixture was poured into a separator funnel, where there was the separation of the raw glycerol from the methyl- ester (**Figure 3.3.1.5**). The glycerol was removed through the tap positioned in the lower part of the funnel, while the methyl-ester was washed with distilled water. In particular, three consecutive washings were carried out with a quantity of water equal to 500 ml for each wash. In this way, the biodiesel was purified, "washing" in the water (liquid-liquid extraction) to remove catalysts or other residues (**Figure 3.3.1.6**).

Ten representative samples of biodiesel, 5 of linseed and 5 of camelina, were analyzed at the Agenzia delle Dogane specialized laboratory in order to determine:

- ✚ FAME (Fatty Acid Methyl Ester) content [%]
- ✚ Glycerol content [%]
- ✚ Water content [mg/kg]
- ✚ Methanol content [%]
- ✚ Linolenic acid methylester [%]

In detail, the differentiation among the five samples for each crop regarded the two temperature of reaction, the three catalyst concentration.



Furthermore, other two biodiesel samples, one of linseed and one of camelina, were analyzed at the CIRDER laboratory in order to determine:

- + Density [g/cm<sup>3</sup>]
- + Higher Heating Value [MJ/kg]



**Figure 3.3.1.5.** Glycerol separation



**Figure 3.3.1.6.** Washing purification

### 3.4. Process flow chart: screw pressing and trans-esterification

Before starting the experiment, it was necessary to schematize the entire process (Figure 3.4.1). For this reason we realized the following flow sheet, in order to underline the crucial phases and the possible process critical situation.



**Figure 3.4.1.** Flow chart of the oil extraction and biodiesel transesterification from high content oil seeds

### **3.5. Energy Return On Energy Invested**

In order to assess the sustainability of *Camelina sativa* L. and *Linum usitatissimum* L. cultivation for biodiesel production in terms of energy used (Input) compared to that obtained (Output), the index EROEI (Energy Return On Energy Invested) was used.

---

The Output represents the energy which is possible to obtain by the products used for the cultivation, while the Input refers to the factors of production used for the cultivation, whether direct or indirect (machinery and equipments, diesel fuel and lubricant oil, products for plant protection, fertilizers, etc.).

This methodology involves the use of the so-called energetic equivalents (or indexes), which represent, in the case of Input, the cost of energy incurred for the use of machinery during the various cultural practices and for the consumption of materials necessary for cultivation (seeds, fertilizers, herbicides, etc.), while, in the case of Output, the energy which can be obtained from the crop (vegetable oil, biodiesel, etc.).

For each farm machine used during the experimentation it was possible to find in the literature the energetic equivalent amount (expressed in MJ/h), which indicates the energy used per each hour of machine use; while the consumption of diesel fuel and lubricant oil are calculated separately (Baldini et al., 1982; Unakitan et al. 2010). Energetic indexes were found in the literature also for seeds, fertilizers, herbicides, diesel fuel and lubricant oil, oil extraction and transesterification; these are expressed in MJ per unit of product (Baldini et al., 1982; Volpi, 1992; Fore et al., 2011).

In the case under consideration, the Output is represented by the energy content of biodiesel produced by the transesterification of vegetable oil

mechanically extracted from seeds. The energetic equivalent for the biodiesel is considered equal to the calorific power that is 37.25 MJ/L (Avella et al., 2009).

It is assumed that both for the extraction of oil from seed and for the transesterification of the same are required 5.31 MJ/L of biodiesel (Fore et al., 2011), defined as energy consumed during the processes for machines (screw-press and transesterification machine), electricity, methanol and sodium hydroxide (reagents and catalysts). At the end, these Input data related to the process shall be in addition to those relating to the cultivation in order to obtain the total Input.

Most recent energetic equivalents are reported in the literature and are worthy of note, but the values are often aggregated or missing and therefore it was not appropriate to consider them in this work (Singh et al., 2006; Ozkan et al., 2007; Da Silva et al., 2010; Zelina et al., 2011).

Other Authors suggest to calculate the specific energetic equivalent only for each machine used. For example, Volpi 1992 estimated the average energetic content of the raw material of the agricultural machine through a survey carried out on the manufacturing industries as reported in the table 3.5.1.

**Table 3.5.1.** Raw materials energetic content

<b>Raw material</b>	<b>Unitary energetic content [kg/kg*]</b>
Ferrous materials	1.5
Non-ferrous materials	2.0
Light alloy	8.0
Other material	2.5

\*kg of equivalent oil per kg of raw material

On the basis of the raw material energetic content and of the agricultural machine composition, the energetic equivalent per unit of mass for each machine was estimated (Table 3.5.2).

## Section II: The Biodiesel

**Table 3.5.2** Energetic equivalent for different kind of agricultural machine.

Machine	Ferrous materials	Non-ferrous materials	Light alloy	Other material	Energetic content
	%	%	%	%	[kg/kg*]
Engine	65	8	25	2	3.2
Crawler tractors (no-engine)	95	3	1	1	1.6
Wheels tractors (no-engine)	86	3	1	10	1.7
Soil tillage machines	96	-	-	4	1.5
Pump and spray bars	90	3	3	2	1.7
Harvesting machines	60	1	1	4	1.7

\*kg of equivalent oil per kg of raw material

As is known, the tonne of oil equivalent (TOE) is one of the mostly used unit for different comparisons products and it has an energetic content of 41.86 GJ/t (D.M. 20/07/2004 and EEN 03/08).

Knowing the mass and the average working life of each machine used, we are able to calculate hourly energy cost for each of them, expressed in MJ/h following the equation:

———— energetic equivalent ————

The energetic cost due to the use of the machines for each cultural practice is calculated by multiplying the energetic equivalent [MJ/h] and the practice unitary time [h/ha] (Volpi, 1992).

## 4. Results and discussions

### 4.1. Mechanization and agronomic results

The experimental trials has shown different results for the two species cultivated both for mechanization aspect and for agronomic aspects.

The cultural practices were carried out choosing carefully the machines both for their adaptability to the soil structure and to obtain a good final soil tillage in order to facilitate the crops in the first stages of growth. Moreover, accurate adjustments were carried out on the farm machines both in the farm workshop and in the open field, with particular attention to the seeder and to the harvester in order to optimize their efficiency and to reduce products losses.

The two crops were grown in the same experimental field respectively in two similar plots for their physical-chemical features.

The pre-sowing and post-sowing cultural practices were carried out at the same time for both the crops, so they gave back the same work capacity [ha/h] and unitary time [h/ha].

At the opposite, the sowing has recorded different values more or less remarkable because of the different wide of the seeders also due to the different size of the seed (Table 4.1.1). In fact, the mechanical seeder have a width double than the precision seeder. In addition, in order to ensure accurate seeding, the forward speeds were kept lower than those normally used in open fields which are greater to 2 m/s with these seeders. For this reason also the working capacity were lower (about 1 ha/h) and unitary times higher of the average values found in field for the sowing. So, the percentage on the total of the cultural practices is quite high and equal to about 20% for *C. sativa* and 10% for *L. usitatissimum*.

The harvesting is another interesting practice because of the higher working capacity recorded than other oilseed crops. In fact, other Authors write of working capacities between 1.2 and 1.5 ha/h for crops such as sunflower, rapeseed and soybean (Bentini e Zucchelli, 2007).

**Section II: The Biodiesel**

Our good results, as shown in table 4.1.1, are probably due to the high forward speed that we recorded in the field thanks to the properly adjusting of the awner and the opening of the threshing drum.

**Table 4.1.1.** Working capacity in the experimental field

Cultural practices	Ve	Le	Ce	Unitary time
	m/s	m	ha/h	h/ha
Shredding	0.35	2.50	0.32	3.17
Harrowing	1.40	2.05	1.03	0.97
Hoeing	1.10	1.90	0.75	1.33
Sowing and Fertilizing				
- <i>L. usitatissimum</i>	1.55	2.35	1.31	0.76
- <i>C. sativa</i>	1.56	1.15	0.65	1.55
Rolling	2.20	2.20	1.74	0.57
Weeding	0.95	9.70	3.32	0.30
Harvesting	1.40	5.00	2.52	0.40
	TOTAL		<i>L. usitatissimum</i>	7.50
			<i>C. sativa</i>	8.29

As a result, the total unitary time is rather high for all the two crops considered in respect to other crops. It was of 8.3 h/ha for *C. sativa* and 7.5 h/ha for *L. usitatissimum*. In case of Linseed the unitary time was a little lower than for camelina thanks to a greater work capacity of the sowing due both to the forward speed and to the width of the seeders. As shown in figure 4.1.1 the shredding is the practice that recorded the higher incidence on the total in respect to the other practices. It was around 40% for all the crops.

## Section II: The Biodiesel

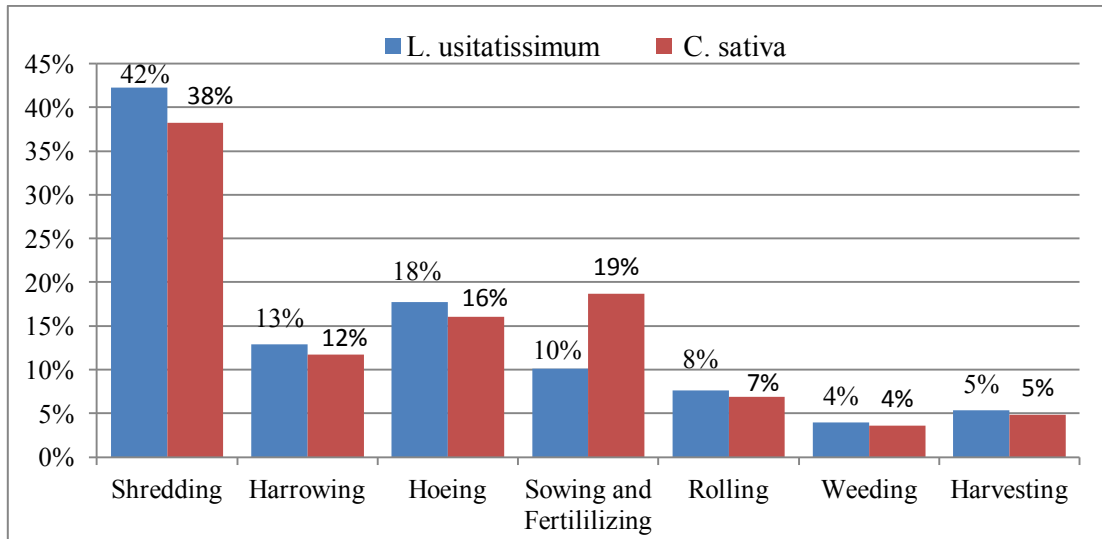

**Figure 4.1.1** Incidence of each cultural practice on the total crops unitary time

The others tillage (harrowing and hoeing) showed similar percentage among 12 and 18% and together account for about 30%. Rolling, weeding and harvesting affect less than 8%, especially the weeding thank to the high work capacity (about 3.3 ha/h).

For each crop, the yield [t/ha], the thousand seed weight [g], the relative humidity [%], the purity [%] and the number of seed for capsule [n] have been evaluated (Table 4.1.2).

**Table 4.1.2.** Agronomic parameters

Crop	Yield	Thousand seeds weight	Relative Humidity	Purity	Seeds per capsule
	t/ha	g/1000 seeds	%	%	n
<i>L. usitatissimum</i>	1.45	4.93	8.33%	91%	9
<i>C. sativa</i>	1.10	1.15	6.26%	92%	11

As a result, the agronomic parameters obtained are comparable with those found in literature. Moreover, the delayed sowing period for this crop has probably led to a reduction in yield which can still oscillate between 0.1 and 1.2 t/ha (Monti and Venturi, 2007).



The yield of *L. usitatissimum* was very similar (1.45 t/ha) to that reported in literature that is of about 1.52 t/ha (Rivoira, 2001). Even the weight of a thousand seeds is one of the values listed in the bibliography: the thousand seeds weight could be in a range between 3 and 15 g (Crescini, 1969) and for most of commonly variety cultivated between 5 and 10 g (Rivoira, 2001).

In the case of *C. sativa*, the yield was about 1.1 t/ha and the thousand seeds weight was about 1.15 g as reported in other studies where yield was between 1.1 and 3.3 t/ha and thousand seeds weight of about 1.2 g (Crescini, 1969; Zubr, 1996; Gugel et al., 2006).

Finally, the puritiy of the seeds was rather low for both the crops. This result contributed to the low oil extraction yield.

## 4.2. Oil extraction results

### 4.2.1. The screw press and its control parameters

Before the start of the oil extraction process, appropriate adjustments of the screw pressing machine were carried. These adjustment were necessary to optimize the process in relation to the seeds characteristics. In addition, some common electric parameters were recorded in order to standardize the results obtained (Table XX). After the trials beginning, the processes were carried out whitout any interruption.

As is shown in Table 4.2.1.1, the electric absorption of the screw press without seeds is a little bit more than 1 kW, while the energy consumption only due to the resistor amount to 0.5 kWh.

**Table 4.2.1.1.** Screw pressing parameters

Parameters	Unit	<i>L. usitatissimum</i>	<i>C. sativa</i>
Power absorbed “empty”	W	1,166	1,155
Resistor power absorbed	W	452	510
Operation power absorbed (no-resistor)	W	1,896	1,710
Eletric voltage	V	210	227

Before starting the extraction trials, an heating machine test was carried out in order to understand how many minutes are necessary to achieve the set point temperature and to know the trend lines of the two parts of the screw press heating (Figure 4.2.1.1).

As is shown in the Figure 4.2.1.1 there in not linearity between the two detection point of the temperature. In fact in about ten minutes the probe CH1 achieve the set point temperature while CH0 temperature is less than 40°C.

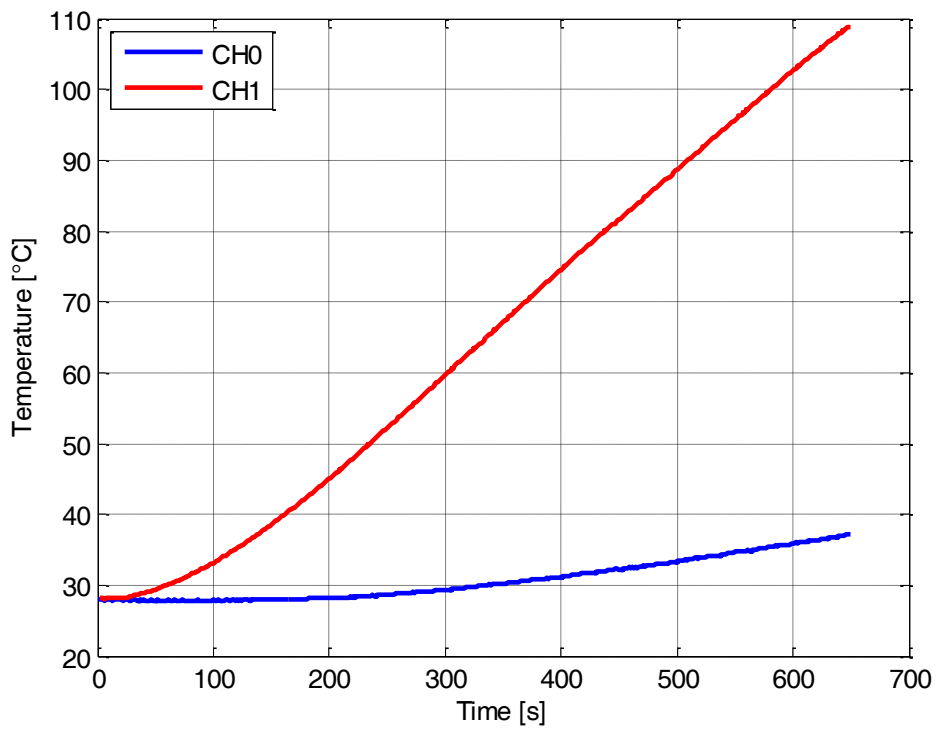

Figure 4.2.1.1. Heating screw press test

The linseed working temperature is shown in figure 4.2.1.2. Even in this case appears that the two probes achieve very different temperatures.

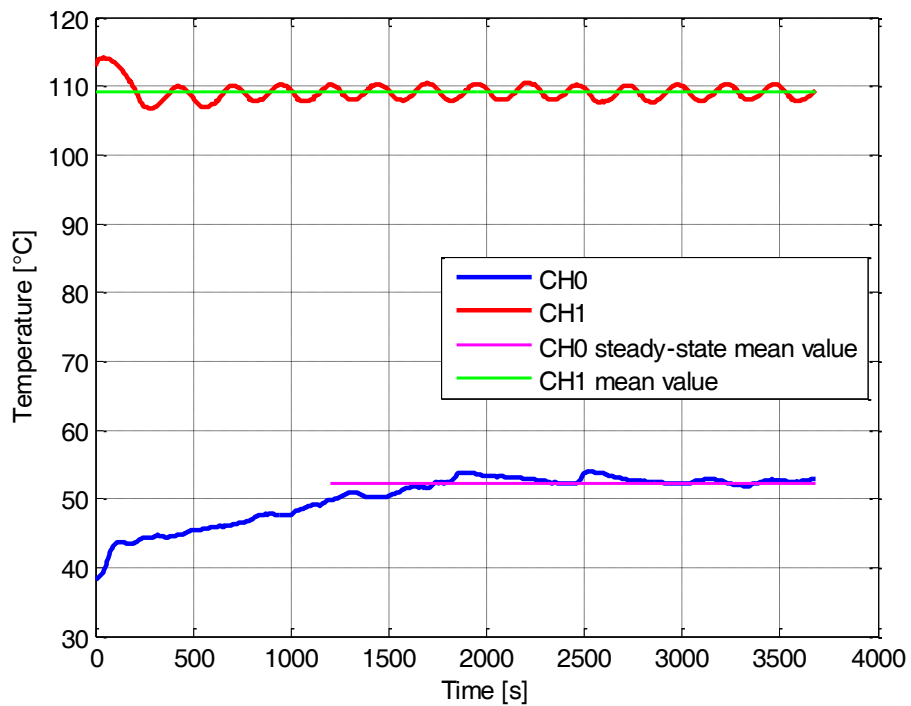
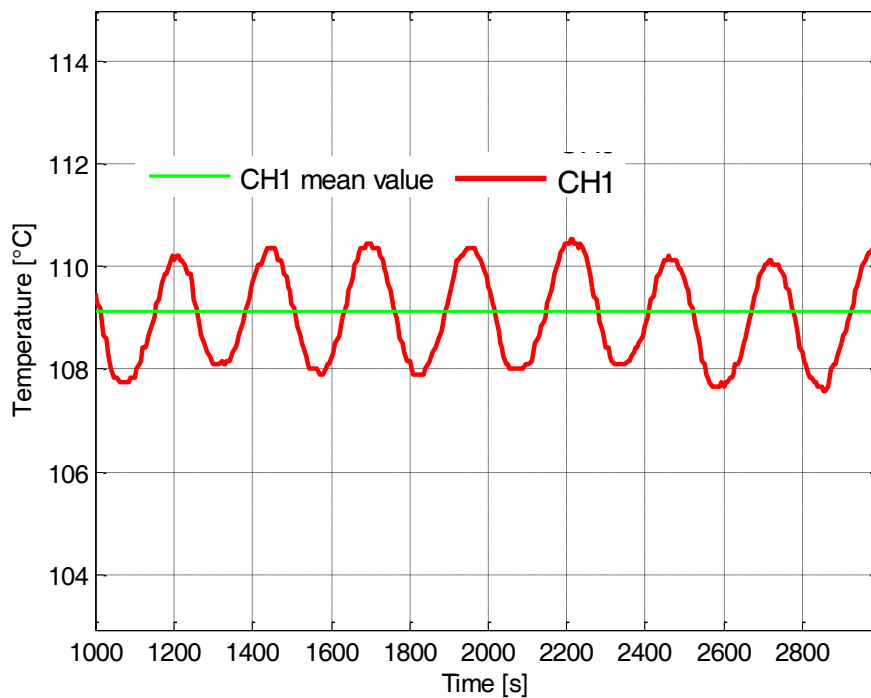

Figure 4.2.1.2. Trend lines of the screw press temperature in two point (CH1 and CH2) during linseed extraction

This trend is of a morning trial started before the preheating of the screw press, in fact starting temperature of probe CH0 is less than 40°C. It need about 20 minutes more for probe CH0 to achieve its working temperature.

It appears that mean temperature of probe CH0 (the part upstream of the press head) remain about 50°C lower than probe CH1. Instead the trend of the probe CH1 shows that despite the set point temperature for linseed was 105°C, the real average working temperature was about 109°C.

Figure 4.2.1.3 shows a zoom of about 30 minutes of the CH1 trend line. It appears that this probe have a sinusoidal trend line, and it correspond to the resistor powering (about one time every 4 minutes).



**Figure 4.2.1.3.** Zoom of the downstream temperature (CH1) in linseed extraction process

The working temperatures of camelina extraction process are showed in figure 4.2.1.4. In this case the extraction trial followed the linseed extraction, in fact the CH0 temperature started from its optimum. As for linseed, also for camelina the two probes demonstrate the big difference between the temperature measured near the electrical resistor (CH1) and the temperature of the probe upstream the press head (CH2) that is of about 50°C.

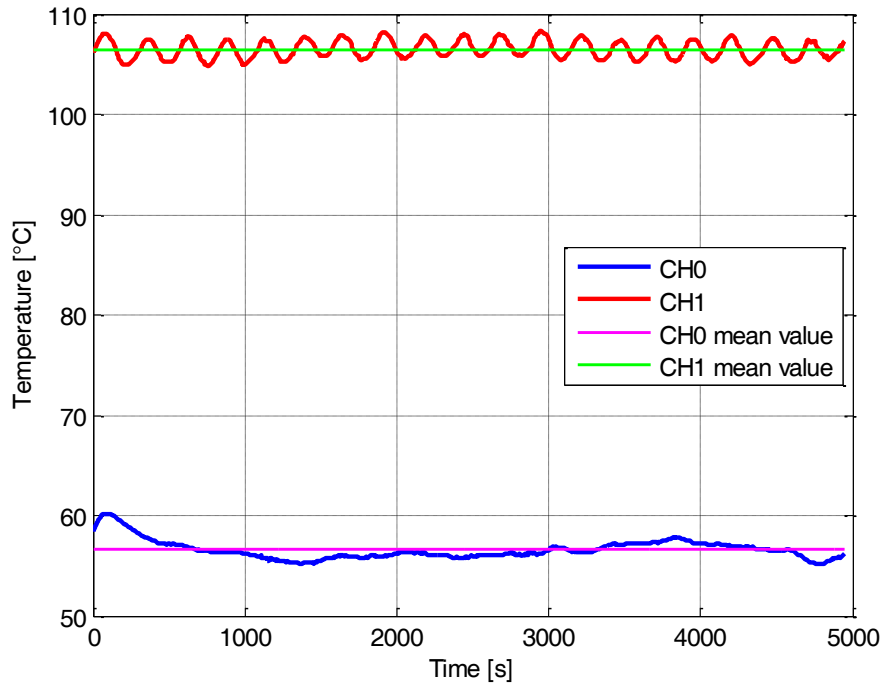

**Figure 4.2.1.4.** Trend lines of the screw press temperature in two point (CH1 and CH2) during camelina seed extraction

Figure 4.2.1.5 shows a 30 minutes zoom of the CH1 trend line. Even in this case the probe have a sinusoidal trend line, and it correspond to the resistor powering (about one time every 4 minutes).

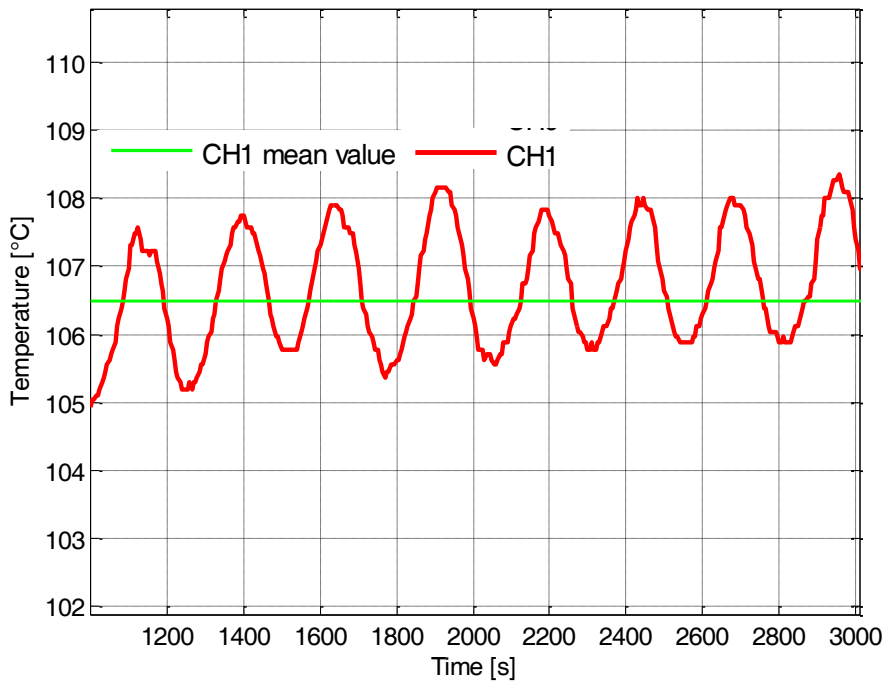

**Figure 4.2.1.5.** Zoom of the downstream temperature (CH1) in linseed extraction process

In table 4.2.1.2 are showed the average and the extremes temperature recorded during the extraction trials in the two control point of the screw press machine.

**Table 4.2.1.2.** Extremes and average values of machine temperatures

Temperature probe	Unit	<i>L. usitatissimum</i>			<i>C. sativa</i>		
		Min	Mean	Max	Min	Mean	Max
Downstream head (CH0)	°C	38.25	61.4	76.3	54.44	57.4	68.34
Upstream head (CH1)	°C	94.1	107.5	114.1	104.77	106.8	111.19

\*our elaboration on data analysis

The average temperature recorded proximally to the resistor was a little bit higher than the set point (105°C). It was 107°C for linseed and 106.7°C for camelina. Instead CH0 registered temperature very lower than the set point (average of 64°C for linseed and 58°C for camelina) and it is due both to the distance from the electric resistance and to the continuous input of new seed which a temperature close to the room temperature.

The vegetable oil and the press cake oil follow the trend of the part of the machine where they are produced (Table 4.2.1.3).

**Table 4.2.1.3.** Average temperature in different control points

Temperature probe	Unit	<i>L. usitatissimum</i>	<i>C. sativa</i>
Oil temperature (CH2)	°C	62.4	58.2
Press cake (CH2)	°C	73.8	70.0
CH3	°C	34.0	35.0
CH4	°C	32.2	32.9

\*our elaboration on data analysis

In fact, the average temperatures recorded by the CH2 probe were around 60°C for the two crops oil and around 70°C for the press cake. On the basis of these results, the oil temperature is related with the upstream press head temperature. In fact the difference between these parameter is of about 1°C for each crops. It means that the main influence on the oil heating is due to the upstream press head that is strictly in contact with the seed pressed.

Instead, the press cake achieves higher temperature than the oil with approximately 10°C more. However it is 35°C less than the downstream press head (CH1). It means that the downstream press head (CH1) temperature and the pressure generated by the squeezing of the seeds against the nozzle, influence the temperature of the press cake. However the retention time of the press cake inside the screw press is not enough to achieve the temperature of the press head (CH1).

#### 4.2.2. The yield obtained and energy consumption

As reported in other works, the average values of oil content in the seed are around 35% for *L. usitatissimum* (Rivoira, 2001) and 38% for *C. sativa* (Gugel and Falk, 2006). It is also known and already discussed in the Section II paragraph 3 that the yield of a mechanical press can achieve 68-80% of the seed oil content (Atabani et al., 2012). As shown in the table 4.2.2.1, the trials carried out confirm the literature. In fact the oil yields achieved were around the 75% of the total oil content of the respective seeds. It is to consider that an hypothetical yield bigger than 30% could be achieved if a double screw press is adopted.

**Table 4.2.2.1.** Work capacity and yield obtained by the use of the mechanical screw press

Parameter	Unit	L. usitatissimum	C. sativa
Oil yield	%	26.4%	28.4%
Press cake yield	%	69.3%	66.2%
Working capacity	kg/h	29	28
Energy consumption per unit of seed pressed	kWh/kg	0.09	0.08

The press cake yields were of 69.3 and 66.3% respectively for linseed and camelina. Summing the press cakes and oils yields we obtain total yields of 95.7 and 94.6%. It means that from 100 kg of seeds worked the losses amounting to 4.3 and 5.4% respectively for the two crops under study. These

losses may be partly due to the evaporation of the seeds water content in the extraction processes.

As reported in table 4.2.2.1 the values of the effective working capacity are lower than the nominal working capacity of 40 kg/h declared from the building industries.

The average power absorbed during the operation process is around 1.9 kW for linseed and 1.7 kW for camelina in respect of the 3 kW of nominal power. It mean that the machine get a an efficiency of about 63% in the first case and about 57% in the second cases.

The energy consumption per kilogram of seed worked is 0.09 kWh for the linseed and 0.08 kWh per camelina. Reporting the energy consumption to the oil production, it appears that 0.34 kWh and 0.28 kWh are used per each kilogram of linseed and camelina oil.

### **4.2.3. Oils and press cakes characterization**

With the objective of standardizing the products obtained by the seed pressing, the oils and the press cakes were characterized through physico-chemical analysis. In detail, in Table 4.2.3.1 are reported the fatty acid composition of the two oil samples. Instead the volumetric mass density of oil samples, the dry matter of the press cake samples and the higher heating value (HHV) of both the oil and press cake samples are showed in Table 4.2.3.2.



## Section II: The Biodiesel

**Table 4.2.3.1.** Fatty acids composition of linseed and camelina oil<sup>1</sup>

Acido	C:D <sup>2</sup>	<i>L. usitatissimum</i>	<i>C. sativa</i>
Myristic	14:0	0.05 %	0.05%
Palmitic	16:0	5.69 %	5.22%
Palmitoleic	16:1	0.11 %	0.12%
Heptadecanoic	17:0	0.06 %	0.05%
Stearic	18:0	4.17 %	2.36%
Oleic	18:1	17.56 %	15.41%
Linoleic	18:2	14.64 %	17.46%
Linolenic	18:3	57.15 %	35.75%
Arachidic	20:0	0.14 %	1.29%
Eicosenoic	20:1	0.14 %	14.70%
Behenic	22:0	0.15 %	0.29%
Erucic	22:1	-	2.94%
Lignoceric	24:0	0.08 %	-
Nervonico	24:1	-	0.56%

<sup>1</sup> Test Report, Agenzia delle Dogane, Chemical Laboratory of Catania

<sup>2</sup> Number of carbon atoms : number of double bonds

In the table above, it appears that almost the 90% are unsaturated fatty acids for both the samples analyzed. Moreover, in the linseed oil case, the three unsaturated fatty acids with 18 carbon atoms represent almost the totality of the unsaturated fatty acids content (93.52%). Instead, in the camelina case, the Eicosenoic (20:1) and Erucic (22:1) acids represent two important fatty acids of the unsaturated group with respectively 14.7 and 2.94% of the total.

Taking into account the European Standards EN142213 (heating fuels) and EN14214 (vehicles traction), the fatty acids composition of linseed and camelina could determinate the production of a poor quality biodiesel. Considering that the upper limit of linolenic acid methyl ester is 12% of the FAME, the linolenic fatty acid content in the oil may contribute to the lowering of the biodiesel oxidation stability. In the other hand the low saturated fatty acids content (around 10%) should reduce the biodiesel freezing point.

**Table 4.2.3.2.** Oils and press cakes characterization\*

Unit	Density g/cm <sup>3</sup>	Dry matter %	HHV MJ/kg
Linseed oil	0.9280±0.03	-	37.3525±0.02
Camelina oil	0.9327±0.04	-	35.9594±0.03
Linseed press cake	-	91.5	19.6308±0.02
Camelina press cake	-	91.2	20.7061±0.01

\*Test report, CIRDER laboratory

The linseed oil density is quite similar to values reported in literature of 0.925 g/cm<sup>3</sup> (Lang et al., 2001), instead a value of 0.906 g/cm<sup>3</sup> is reported for camelina (Bernardo et al., 2003) which is barely lower than the result of this study.

The press cakes have registered high values of dry matter and it means that this biomass could be very useful for energy production by combustion. In addition the higher heating values justify their possible use. The residual energy of the press cake is due both for the oil content (6-10%) and for the remaining organic carbon content in the seeds.

### 4.3. Transesterification results

#### 4.3.1. Characterization

In order to evaluate the quality of the biodiesel produced in the experimental trials, and to define the optimum condition of transesterification for linseed and camelina oils, physico-chemical analysis were carried out on representative gross samples (Table 4.3.1.1).

It appears that refinement is necessary to have a biodiesel of good quality in respect to the Standard EN14214 and 14213. In fact methanol and water are out of the standard limits. Moreover the linolenic acid methylester content registered values of 50-55% for biodiesel and 31-34% for camelina. These values are bigger than the upper limits of the EN 14214 and it means that it is not usable as vehicles fuel.

**Table 4.3.1.1.** Characterization of biodiesel samples\*

<i>Linum usitatissimum</i>					
Process condition	Gross FAME	Net FAME	C18:3	Methanol	H <sub>2</sub> O [ppm]
Catalyst 0.75%	89.2%	90.8%	50.6%	1.5%	2520
Catalyst 1.00%	89.6%	91.3%	50.8%	1.6%	2510
Catalyst 1.25%	97.3%	99.0%	55.3%	1.4%	2790
Temperature 50°C	94.3%	96.0%	53.3%	1.5%	2800
Temperature 60°C	93.9%	95.6%	53.4%	1.5%	2490
<i>Camelina sativa</i>					
Process condition	Gross FAME	Net FAME	C18:3	Methanol	H <sub>2</sub> O
Catalyst 0.75%	86.7%	88.6%	31.4%	1.7%	4580
Catalyst 1.00%	93.1%	95.3%	33.5%	1.9%	4410
Catalyst 1.25%	96.8%	99.2%	32.9%	2.0%	3750
Temperature 50°C	90.7%	92.6%	32.4%	1.7%	3430
Temperature 60°C	92.9%	95.0%	33.8%	1.9%	3370

\* Test Report, Agenzia delle Dogane, Chemical Laboratory of Catania

In addition, if we consider the Net FAME, yields of 90-98% and 88-99% were achieved respectively for linseed and camelina. The lower limit for FAME content is of 96.5% both for the Standards EN 14214 and EN 14213. In this case only the trials carried out with 1.25% of catalyst appears suitable for energetic use (99% for linseed and 99.2% for camelina).

Table 4.3.1.2 shows the density and the Higher Heat Values of two samples of linseed and camelina Biodiesels

**Table 4.3.1.2.** Density and Higher Heat Value of linseed and camelina biodiesels\*

Unit	Density g/cm <sup>3</sup>	HHV MJ/kg
Linseed biodiesel	0.8943±0.03	38.0808±0.06
Camelina biodiesel	0.8851±0.03	37.9370±0.04

\*Test report, CIRDER laboratory

### 4.3.2. *Linum usitatissimum*

A recent research shows that yields between 88 and 96 kg of biodiesel from transesterification of 100 kg of vegetable oil under alkaline catalysis condition are obtainable (Kumar *et al.*, 2013). The authors also report that the yield differences observed are related to the amount of reagent, catalyst and process temperature employed.

**Section II: The Biodiesel**

Table 4.3.2.1 shows the yields obtained in all the tests carried out on the basis of the parameters of reaction showed in the table 3.3.3.1. It appears that the net yield obtained in the laboratory transesterification test are bigger than the literature. In fact, they achieved yield between 93.4% and 98.0%.

**Table 4.3.2.1.** Biodiesel yield of all the transesterification tests from linseed oil

<b>Linum usitatissimum</b>					
Sample	Temperature	Methanol ratio	Catalyst KOH	Gross Yield	Net Yield
	°C	mol:mol	%	%	%
1	50	4.5:1	0.75%	98.1%	96.4%
2	50	6.0:1	0.75%	99.1%	97.4%
3	50	7.5:1	0.75%	99.8%	98.0%
4	50	4.5:1	1.00%	97.1%	95.3%
5	50	6.0:1	1.00%	98.5%	96.6%
6	50	7.5:1	1.00%	98.9%	97.1%
7	50	4.5:1	1.25%	95.0%	93.4%
8	50	6.0:1	1.25%	96.6%	94.9%
9	50	7.5:1	1.25%	98.6%	97.0%
10	60	4.5:1	0.75%	97.1%	95.4%
11	60	6.0:1	0.75%	98.1%	96.4%
12	60	7.5:1	0.75%	98.2%	96.5%
13	60	4.5:1	1.00%	96.4%	94.6%
14	60	6.0:1	1.00%	97.6%	95.8%
15	60	7.5:1	1.00%	98.5%	96.6%
16	60	4.5:1	1.25%	95.5%	93.9%
17	60	6.0:1	1.25%	97.0%	95.4%
18	60	7.5:1	1.25%	98.6%	97.0%
MEAN	-	-	-	97.7%	96.0%

The average of the yield is of 96.0%. The bigger yield values are in correspondence of the bigger amount of methanol used at the same other condition (samples 3-6-9-12-15-18). Instead the process temperature seems don't have effects on the yield obtained (samples 1-9 and 10-18)

Finally, putting on relationship the data showed in tables 4.3.1.1 and 4.3.2.1 it appears that of all the trials 7-8-9-16-17-18 respect the requirements of the Standard EN 14213 and so they are biofuels usable for heating purpose.

### 4.3.3. *Camelina sativa*

The yields obtained in the transesterification trials of camelina oil demonstrate a good adaptability of its oil for biodiesel production (Table 4.3.3.1)

**Table 4.3.3.1.** Biodiesel yield of all the transesterification tests from camelina oil

<b>Camelina sativa</b>					
	<b>Temperature</b>	<b>Methanol ratio</b>	<b>Catalyst KOH</b>	<b>Gross Yield</b>	<b>Net Yield</b>
	<b>°C</b>	<b>mol:mol</b>	<b>%</b>		
1	50	4.5:1	0.75%	96.6%	94.5%
2	50	6.0:1	0.75%	97.8%	95.7%
3	50	7.5:1	0.75%	97.5%	95.4%
4	50	4.5:1	1.00%	95.4%	93.2%
5	50	6.0:1	1.00%	96.4%	94.1%
6	50	7.5:1	1.00%	97.7%	95.4%
7	50	4.5:1	1.25%	94.7%	92.4%
8	50	6.0:1	1.25%	95.4%	93.2%
9	50	7.5:1	1.25%	96.8%	94.5%
10	60	4.5:1	0.75%	96.9%	94.8%
11	60	6.0:1	0.75%	96.9%	94.8%
12	60	7.5:1	0.75%	98.3%	96.2%
13	60	4.5:1	1.00%	95.7%	93.5%
14	60	6.0:1	1.00%	97.5%	95.2%
15	60	7.5:1	1.00%	96.6%	94.3%
16	60	4.5:1	1.25%	93.6%	91.3%
17	60	6.0:1	1.25%	94.1%	91.9%
18	60	7.5:1	1.25%	95.6%	93.3%
MEAN	-	-	-	96.3%	94.1%

As is shown in the table the biodiesel production range from 91.3% and 96.2%. Even in this case there are not remarkable difference between the test carried out at two set point temperature (samples 1-9 and 10-18). Moreover for camelina biodiesel the difference between the trials conducted with different concentration of catalyst don't are remarkable such as the linseed trials.

Finally, as already done for linseed, putting on relationship the data showed in tables 4.3.1.1 and 4.3.3.1 it appears that even in this case the trials 7-8-9-16-17-18 produced biofuels usable for heating purpose.

#### 4.4. Energetic results

In order to evaluate the sustainability of the energetic crops the EROEI index was calculated. To do this, the energy gained with the biodiesel producible and that consumed for machines and products used were compared.

In Table 4.4.1 is reported the energy consumption for the use of the machine due to the energy embodied in each of them.

**Table 4.4.1.** Energy consumption due to use of machines

Cultural practices	Unitary time	Energetic index		Energy required		Total
		tractor	operating machine	tractor	operating machine	
	h/ha	MJ/h	MJ/h	MJ/ha	MJ/ha	MJ/ha
Shredding	3.17	27.13 <sup>[1]</sup>	2.26 <sup>[1]</sup>	86.13	7.17	93.30
Harrowing	0.97	27.13 <sup>[1]</sup>	6.07 <sup>[1]</sup>	26.26	5.87	32.13
Hoeing	1.33	27.13 <sup>[1]</sup>	2.51 <sup>[1]</sup>	36.06	3.34	39.39
Sowing and Fertilizing						
- <i>L. usitatissimum</i>	0.76	27.13 <sup>[1]</sup>	1.76 <sup>[1]</sup>	20.69	1.34	22.03
- <i>C. sativa</i>	1.55	27.13 <sup>[1]</sup>	1.76 <sup>[1]</sup>	42.01	2.73	44.73
Rolling	0.57	27.13 <sup>[1]</sup>	6.07 <sup>[1]</sup>	15.57	3.48	19.05
Weeding	0.30	13.08 <sup>[1]</sup>	0.61 <sup>[1]</sup>	3.94	0.18	4.13
Harvesting	0.40	87.63 <sup>[2]</sup>	-	34.77	-	34.77
				TOTAL		
					<i>L. usitatissimum</i>	244.81
					<i>C. sativa</i>	267.52

<sup>[1]</sup> Baldini *et al.*, 1982

<sup>[2]</sup> Unakitan *et al.*, 2010

The cultural practice that recorded the maximum Energy required was the shredding with an incidence between 34.9 and 38.1% on the total (Figure 4.4.1). This result is strictly related to the high unitary time required by the tillage.

Likewise, the sowing was again the practice that recorded the maximum difference between the two crops due to the different seeders used. In fact, for *L. usitatissimum* cultivation a value of about the half than *C. sativa* was registered. On the other hand, the chemical weeding showed the lower energy consumption a little bit more than 1%, also because of the lowest values of

energetic equivalents considered in this cultural practice for the tractor and the operating machine.

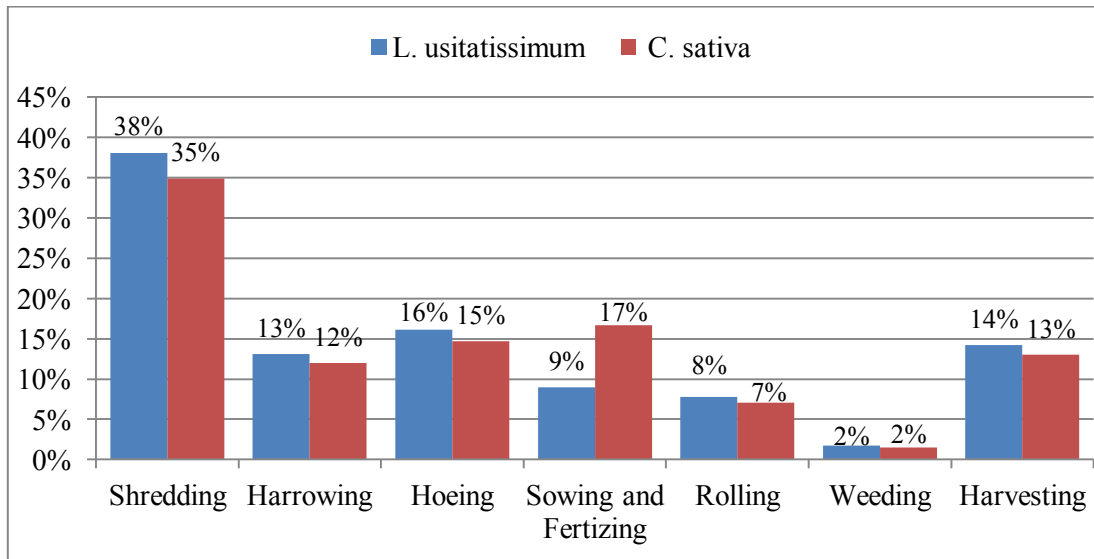

Figure 4.4.1. Incidence of each cultural practice on the total energy required for each crop.

The total for each crop shows negligible differences between the species and amounts to a few tens of MJ/ha, due only to the different unitary times of the sowing.

The detailed consumptions of fuel and lubricant are reported in table 4.4.2, where also the percentage of every single practice for each culture is showed.

Table 4.4.2. Diesel fuel and lubricant oil consumption

Cultural practices	Diesel fuel [kg/ha]	Incidence		Oil lubricant [kg/ha]
		<i>L.usitatissimum</i>	<i>C.sativa</i>	
Shredding	17.10	26.6%	23.8%	0.55
Harrowing	12.53	19.5%	17.5%	0.45
Hoeing	17.21	26.8%	24.0%	0.62
Sowing and Fertilizing				
- <i>L. usitatissimum</i>	2.12	3.3%		0.08
- <i>C. sativa</i>	9.54		13.3%	0.31
Rolling	1.10	1.7%	1.5%	0.04
Chemical weeding	1.27	2.0%	1.8%	0.04
Harvesting	12.99	20.2%	18.1%	0.42
<b>TOTAL</b>				
	<i>L. usitatissimum</i>	64.32	100%	2.19
	<i>C. sativa</i>	71.75	100%	2.43

As already seen for the use of the machines in table 4.4.1, even in this case the differences between the fuel and lubricant consumptions are strictly related to the unitary time needed to carry out each cultural practice. In fact, in both cases, the tillage and harvesting recorded in total more than 80% of the consumption, while the rolling and the chemical weeding were always equal or less than 2% (Figure 4.4.2).

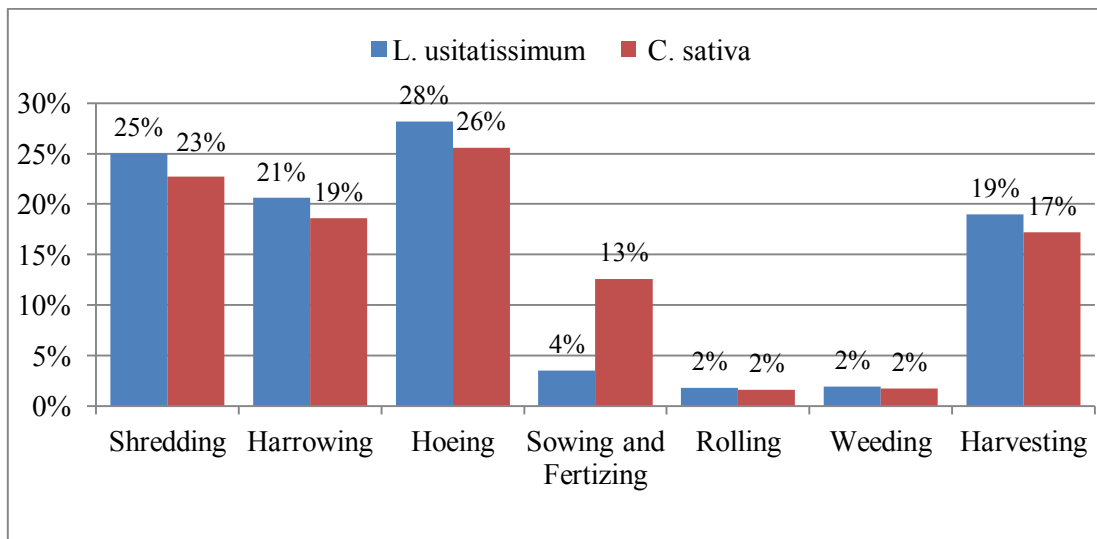

Figure 4.4.2. Incidence of diesel fuel and oil lubricant for each agricultural practice

Also the sowing confirmed a big difference, almost 10%, between mechanical or pneumatic seeder used. This result primarily affects the total amount of diesel fuel consumed in the two crops. In particular, the cultivation of *L. usitatissimum* involves a saving of about 7-8 kg/ha compared to *C. sativa* cultivation.

To assess the total energy consumption for all the products used, fertilizer, herbicide and seeds were considered together to diesel fuel and oil lubricant (Table 4.4.3).

Looking at the table, it appears that the fertilizer represents the product which involves the higher Energy required with value around 7 thousand MJ/ha (about 60% on the total).



## Section II: The Biodiesel

**Table 4.4.3.** Energy consumption for all the products used during the cultivation

Product	Quantity	Energetic index	Energy required	<i>L. usitatissimum</i>	<i>C. sativa</i>
	kg/ha	MJ/kg	MJ/ha	%	%
<b>Diesel fuel</b>					
- <i>L. usitatissimum</i>	64.3	52.34 <sup>[1]</sup>	3,366	28.35%	
- <i>C. sativa</i>	71.8	52.34 <sup>[1]</sup>	3,756		32.99%
<b>Oil lubricant</b>					
- <i>L. usitatissimum</i>	2.20	45.51 <sup>[1]</sup>	100	0.84%	
- <i>C. sativa</i>	2.43	45.51 <sup>[1]</sup>	111		0.97%
Fertilizer	320	22.09 <sup>[1]</sup>	7,069	59.53%	62.09%
Herbicide	1.0	343.32 <sup>[1]</sup>	343	2.89%	3.02%
<b>Seeds</b>					
- <i>L. usitatissimum</i>	39	25.54 <sup>[2]</sup>	996	8.39%	
- <i>C. sativa</i>	4.2	25.54 <sup>[2]</sup>	107		0.94%
<b>TOTAL</b>					
		<i>L. usitatissimum</i>	11,875	100%	100%
		<i>C. sativa</i>	11,386		

<sup>[1]</sup> Baldini et al., 1982

<sup>[2]</sup> Volpi, 1992

Also the values of Energy required for the diesel fuel consumption are also quite high around 3,500 MJ/ha. This two products represent together about 90% of the total of Energy required for the use of the products during the cultivations. In the case of *L. usitatissimum* the use of seeds is energetically relevant because of the high quantity used for sowing (39 kg/ha). The seed represents about 8% of the total Energy required, while for *C. sativa* it is around 1% (Figure 4.4.3).

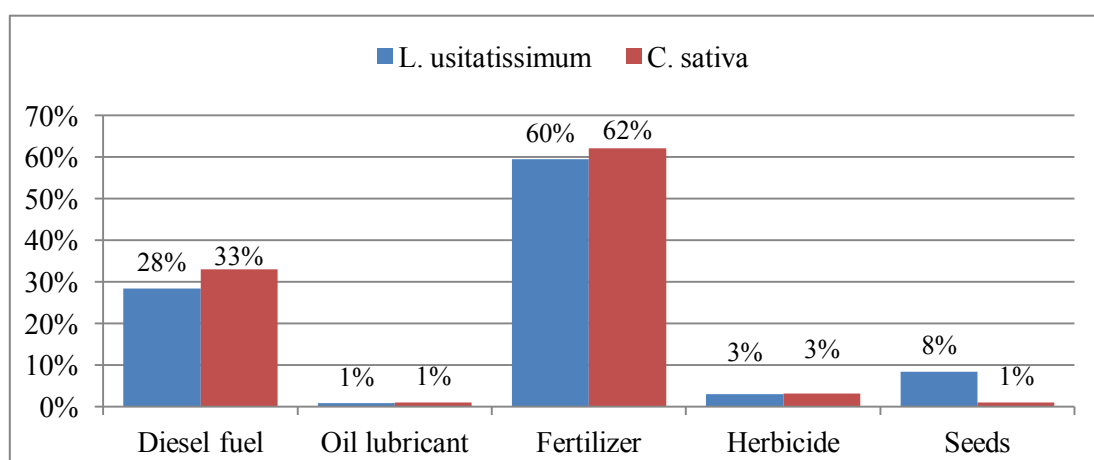

**Figure 4.4.3.** Incidence of the product used in the cultivation of the two crops

An analysis of the energy consumption relating to machinery, diesel fuel, lubricant oil, fertilizer, herbicide and seed showed that the sowing together to the fertilizing becomes the cultural practice which requires more than 65% of total energy used for the cultivation (Figure 4.4.1). The alignment of values concerning the sowing and fertilizing in the two crops is due principally to the amount of energy required to the fertilizer used.

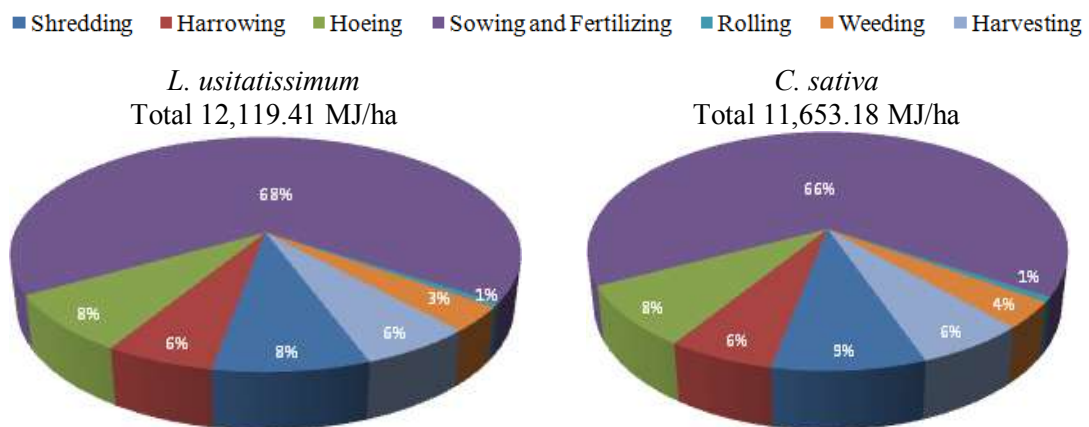

**Figure 4.4.1.** Energy use of machinery, diesel fuel, oil lubricant, seeds, herbicide and fertilizer for each cultural practice in the three crops

Despite the use of herbicide, the chemical weeding remains, after rolling, the practice that requires the smallest amount of energy. This is due to the small dose required for after sowing treatment for oilseed crops. The others practices are quite similar with values that range from 700 to 1,000 MJ/ha each.

Finally, in order to calculate the total energetic Input for the cultivation of one hectare of the two different oilseed crops, the amount of biodiesel producible from each crop is estimated on the basis of the maximum yield achieved in the laboratory trials. In Table 4.4.4 are resumed the oil extraction yield and the biodiesel transesterification yield obtained in the trials.

Table 4.4.4 shows the biodiesel production from one hectare of each crop. These values are obtained considering the seeds yield of in the field test and

## Section II: The Biodiesel

the average of the transesterification yields of the laboratory transesterification trials. The density parameters are from the CIRDER laboratory analysis (Table 4.3.3.2)

**Table 4.4.4.** Biodiesel production per hectare

Crop	Seeds	Extraction Yield	Vegetable oil	Trans-esterification Yield	Biodiesel	Density	Biodiesel
	t/ha	%	kg/ha	%	kg/ha	g/cm <sup>3</sup>	L/ha
<i>L. usitatissimum</i>	1.42	27.9%	361	96.0%	346.56	0.894	387.65
<i>C. sativa</i>	1.15	28.3%	308	94.1%	289.83	0.885	327.49

The subsequently step consists to calculate the Input due to the extraction and transesterification of the oil, that in literature are grouped with only one index (Fore et al., 2011). The total Input are showed in table 4.4.5.

**Table 4.4.5.** Total Input for cultivation and transformation processes

Crop	Biodiesel	Input Energetic index	Process Input	Cultivation Input	Total Input
Unit	L/ha	MJ/L	MJ/ha	MJ/ha	MJ/ha
<i>L. usitatissimum</i>	387.65	5.31*	2,058.42	12,118.34	14,177
<i>C. sativa</i>	327.49	5.31*	1,738.98	11,651.06	13,390

\*Fore et al., 2011

In order to obtain the total Output, in table 4.4.6 are calculated the two part of the Output for each crop due to the energy content of the biodiesels and the energy content of the press cakes.

**Table 4.4.6.** Total Output for Biodiesel and press cake production

Crop	Biodiesel	Energetic index	Biodiesel Output	Press cake	Press cake Index	Press cake Output	Total Output
Unit	L/ha	MJ/L	MJ/ha	kg/ha	MJ/kg	MJ/ha	MJ/ha
<i>L. usitatissimum</i>	387.65	37*	14,343	984	19.63	19,316	33,659
<i>C. sativa</i>	327.49	37*	12,117	761	20.70	15,753	27,870

\*RED 2009/28/EC

Finally, in table 4.4.7 the Energy return On Energy Invested was calculated. It appears that the value is more than 2 for both the crops. It means that the two crops are sustainably in term of energy generated in respect with the energy invested for the cultivation.

**Table 4.4.7.** Energy Return On Energy Invested (EROEI index)

Crop	Total Input	Total Output	EROEI index
Unit	MJ/ha	MJ/ha	
<i>L. usitatissimum</i>	14,177	33,659	2.37
<i>C. sativa</i>	13,390	27,870	2.08

The total energetic Input data of the process are closely related to the yields and therefore higher values are those of *L. usitatissimum*, follow to the *C. sativa*. Similarly also the total amount of energy consumed follows the same order. However, the values obtained are lower than those reported in literature for other crops (Cosentino et al., 2008).

In figures 4.4.4 and 4.4.3 are showed the EROEI Index respectively for linseed and camelina for all the biodiesel yields of the laboratory trials.

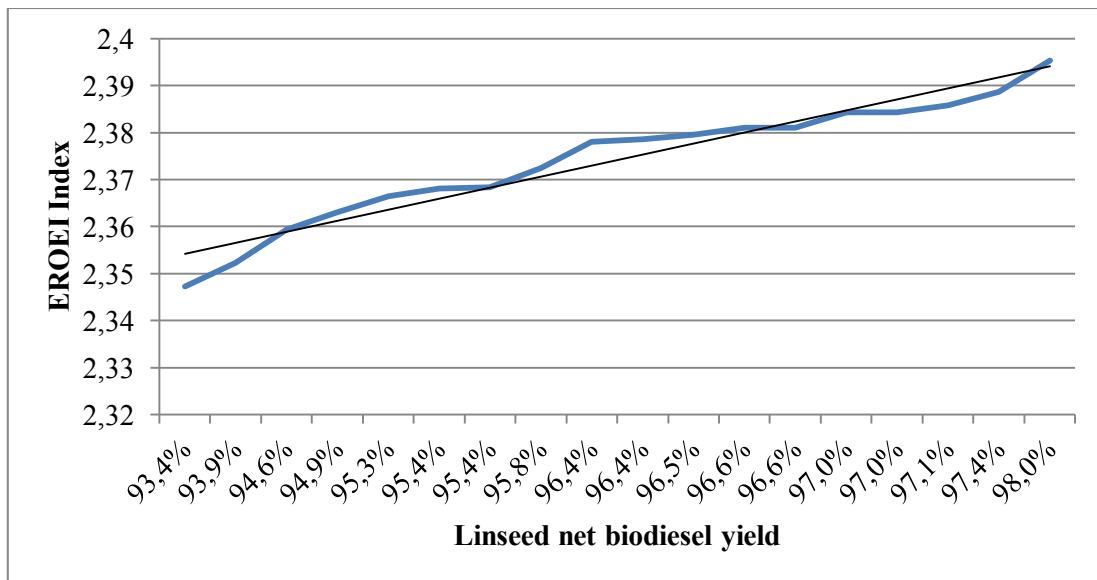

**Figure 4.4.2.** Trend line of the linseed EROEI index related with the biodiesel yield obtained

It appears that in both cases the EROEI index is related with the biodiesel yield, even if the press cakes play an important role in the efficiency of the cultivation for energy purpose.

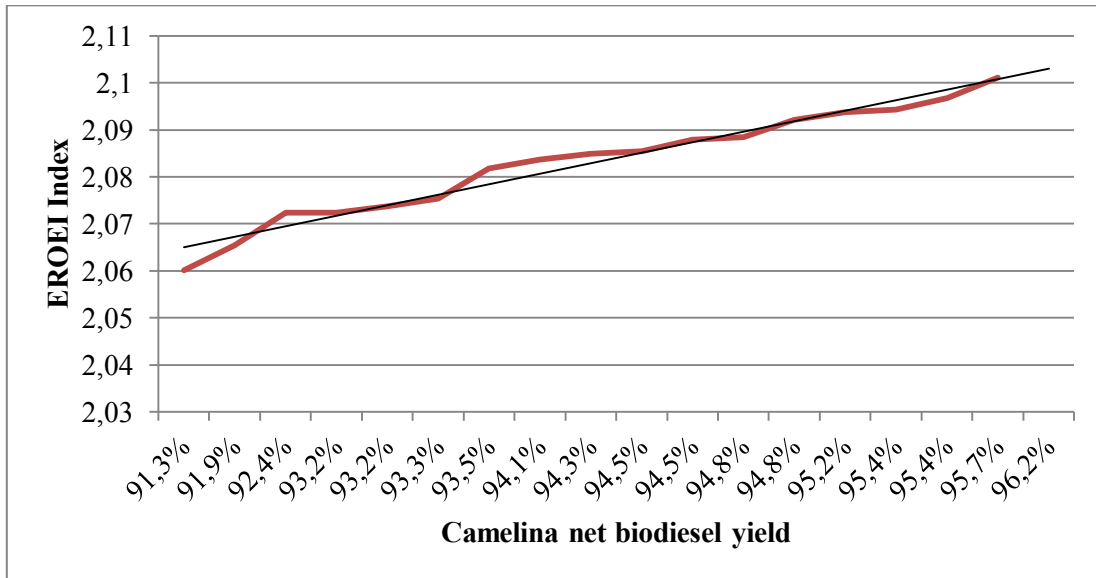

Figure 4.4.3. Trend line of the Camelina EROEI index related with the biodiesel yield obtained

## 5. Conclusions

The research activities aimed to verify the technical and economic feasibility of oil bearing crops such as *Linum usitatissimum*, and *Camelina sativa*, grown for the production of vegetable oils and biodiesel.

The study was mainly concerned with the following aspects:

- to assess the cultivation sustainability of unconventional oil crops as *Linum usitatissimum* L. and *Camelina sativa* L., in south-eastern Sicily for vegetable oil and biodiesel production in terms of energy used compared to that obtained, by means of EROI index;
- to analyse the mechanical pressing of seeds in terms vegetable oil yields and chemical characteristics, machine work capacity, energy consumptions, characterization of the operating parameters of the screw press plant;
- to evaluate the trans-esterification process in terms of yield into biodiesel by varying the temperature of the process and the amount of methanol and potash and in terms of physical-chemical characteristics of FAME according to EN 14214;
- to estimate the greenhouse gas (GHG) emissions through the data input and output of the production of biodiesel in order to meet the sustainability criteria laid down for the supply chain of biofuels established with the RED (Directive 2009/28/EC).

The experimental trials was carried out in two big non-irrigated plots (of 5000 m<sup>2</sup> each one) and in semi-arid climatic conditions. The tillage were aimed at creating a seedbed very refined and suitable to host very small seeds, such as those of *L. usitatissimum* and *C. sativa*. And for this reason it was necessary to carry out three distinct processes with significant uses of energy and work.

Shredding, for example, with low working capacity and high energy uses, could be avoided by adopting appropriate management techniques to less

impact. A correct soil management could be useful to reduce weeds existent and so to eliminate the shredding that is one of the most expensive cultural practices in term of energy consumption.

In order to reduce energetic costs, due to two-three tillage and rolling, which represent about 70% of the total cost of the machines, the adaptability of direct sowing with simultaneous tillage and sowing could be checked. This solution would allow to reduce the incidence of work times and the consumption of diesel fuels and lubricant oil.

Speaking of sowing is important to emphasize that also a correct use and choosing of the seeder can affect the effective work capacities and therefore energy consumptions as in the case object of study. Also the sowing period is crucial to obtain good yields. These could be higher with a early sowing.

In this regard, the cultivation of *L. usitatissimum* involves a saving of about 7-8 kg/ha of seed compared to the *C. sativa*: on larger farms, these differences can have a considerable economic impact.

Finally, a proper adjustment of the combine-harvester, as well as proper management of weeds, may help to contain the impurities present in the seed during the harvesting. This aspect is very important to maximize the yields of vegetable oil during the pressing.

As regards agronomical aspects, the results show the remarkable adaptability of linseed and camelina cultivation in semi-arid and non-irrigated land in the south-eastern Sicily. This adaptability has been confirmed by the seed yields, comparable with those reported in literature. Even the other characteristics of seeds (moisture content of the seeds, weight of 1000 seeds and number of seeds per capsule) show mean values similar with those of reference for the crops in object.

These could also be higher if we consider a process of squeezing with plants on an industrial scale. The oil yields may have been penalized also by the squeezing system. The prototype, used for the experimental tests, had some limitations in the possibility to adjust the operation parameters such as the

temperature of the cylinder head, the speed of rotation of the screw, the load of the hopper.

About the vegetable oil quality the fatty composition is more equilibrate than that reported in literature (Mapelli and Pecchia, 2011). However the linolenic acid content remain very high.

The transesterification process, carried out at a laboratory scale, has enabled us to achieve very high yields of biodiesel and by an average of 96%. It must be emphasized that in the tests at 50 °C the yields of biodiesel are slightly higher, compared to those reported in the tests at 60 °C but the differences are not significative only for camelina.

From the average of all the data, both those conducted at a temperature of 50°C and those of 60 °C shows that the differences between the yields appear to be significant to the advantage of the test conditions to higher content of potash.

As regards the content in methanol, the highest yields are obtained under test conditions in which, for the same use of potash, the alcohol content is greater (ratio 7,5:1), compared to the other two cases in which the content was respectively equal to a ratio of 6:1 and a ratio of 4.5:1.

The FAME content of the biodiesel shows that only the trials carried out with 1.75% of catalyst generate a biofuel in accordance with the lower limit of the Standards EN 14214 and 14213. At the same time the high value of linolenic acid methylester don't allow to use the biodiesel as vehicle fuel (EN 14214). However, the biofuels are usable for heating purpose in respect to the requirements of the Standards EN 14213 that don't requires a lower limit for linolenic acid methylester.

Even with the limitations inherent in the experimental test in object, the EROI index, used for the assessment of the convenience in terms of energy of the cultivation of linseed and camelina, has shown that the value obtained is greater than the unity and respectively 2.3 and 2.08.



It's important to emphasize, however, that the values of Input are lower than those reported in literature for other crops (Cosentino et al, 2008)

Moreover, in order to decrease the energy input could be reduced the amount of fertilizer to be used. In fact, it represent more than 50% of the totally energy invested.

These results can confirms the convenience to support the cultivation of linseed and camelina for biodiesel production. Also, it is important to note that these crops could also get in rotation with durum wheat also in order to improve its productivity.

Although the results obtained, using the index EROEI, are partial with respect to an overall assessment which provides also for the calculation of greenhouse gas (GHG) emissions, the study in question is a first step to promote the cultivation of oil bearing crops in agricultural areas marginal or abandoned.

The cultivation of linseed and camelina, then, could be a solution for developing land, barely usable differently and become a source of income, as well as contribute to the production of alternative energy from renewable sources. In fact, by improving the performance of the machines only a small part of the produced biodiesel could be used for the cultivation. The residual amount could be a source of income for the farmer.

Moreover, it was estimated that biodiesel may be more convenient than diesel when the oil prices reach 75 €/barrel and even greater economic competitiveness may result from the recognition of the environmental benefits coming from the full chain of biofuels (Monti and Venturi, 2007).

At the end, further studies would be needed to assess the sustainability of biodiesel production from cultivation of *Linum usitatissimum* L. and *Camelina sativa* L. taking into consideration the environmental benefits that may ensue by means of GHG emission assessment.

## References

- ISTAT, 2010, *Caratteristiche strutturali delle aziende agricole*. 6° Censimento Generale dell'Agricoltura, 2010, Roma, ISTAT press.
- Alves M.J., Nascimento S.M., Pereira I.G., Martins M.I., Cardoso V.L., Reis M., 2013, *Biodiesel purification using micro and ultrafiltration membranes*. *Renewable Energy* 58, Elsevier, 15-20.
- Antolín G., Tinaut F.V., Briceño Y., Castaño V., Pérez C., Ramírez A.I., 2002, *Optimisation of biodiesel production by sunflower oil transesterification*. *Bioresource Technology* 83, Elsevier, 111-114.
- Araldi F, Failla S, Restuccia A, Zagni M., **2009** *Vinacce, da scarto industriale a risorsa per produrre biogas*. *L'Informatore Agrario*, suppl. Energia rinnovabile, Vol. 10, pp. 20-23.
- Atabani A.E., Silitonga A.S., Ong H.C., Mahlia T.M.I., Masjuki H.H., Irfan Anjum Badruddin, Fayaz H., 2013, *Non-edible vegetable oils: A critical evaluation of oil extraction, fatty acid compositions, biodiesel production, characteristics, engine performance and emission production*. *Renewable and Sustainable Energy Reviews* 18, Elsevier, pp.211-245.
- Atadashi I.M., Aroua M.K., Aziz A.A., 2011, *Biodiesel separation and purification: A review*. *Renewable Energy* 36, Elsevier, pp.437-443.
- Atadashi I.M., Aroua M.K., Aziz A.A., Sulaiman N.M.N., 2012, *The effect of water on biodiesel and refining technologies: A Review*. *Renewable and Sustainable Energy Reviews* 16, Elsevier, pp.3456-3470.
- Avella F., Faedo D., Macor A., 2009, *Impiego di una miscela gasolio/biodiesel al 30% (B30) nei motori diesel: effetto sulle emissioni*

*inquinanti*. La rivista dei combustibili e dell'industria chimica vol. 63 n.2, pp.2-15.

Bacci L., Baronti S., Angelini L., di Virgilio N., 2007, *Manuale di coltivazione e prima lavorazione del lino e altre piante da fibra*. Collana "Ricerca Trasferimento Innovazione – Settore delle politiche regionali dell'innovazione e della ricerca – Regione Toscana.

Baldini E., Alberghina O., Bargioni G., Cobianchi D., Iannini B., Tribulato E., Zocca A., 1982, *Analisi energetiche di alcune colture arboree da frutto*. Numero Speciale Rivista di Ingegneria Agraria, n.2.

Balsari P., Menardo S., Gioielli F., 2011, *Tecniche di valorizzazione del contenuto energetico delle biomasse*. Biomasse ed Energia: Produzione, gestione e processi di trasformazione, Maggioli Editore, pp.133-161

Banković-Ilić I.B., Stamenković O.S., Veljković V.B., 2012, *Biodiesel production from non-edible plant oils*. Renewable and Sustainable Energy Reviews 16, Elsevier, pp.3621-3647.

Barker H.A., 1956, *Biological Formation of Methane*. Industrial and Engineering Chemistry, pp.1438-1442.

Barut Z.B, Ertekin C., Karaagak H.A., 2011, *Tillage effects on energy use for corn silage in Mediterranean coastal of Turkey*, Energy 36, 5466-5475.

Bentini M., Zucchelli M., 2007, *Aspetti di meccanizzazione delle colture a destinazione energetica*. Annali Accademia Nazionale di Agricoltura Edizione Straordinaria CXXVII, Bologna, 133-146.

Bernardo A., Howard-Hildige R., O'Connell A., Nochol R., Ryan J., Rice B., Roche E., Leahy J.J., 2003, *Camelina oil as a fuel for diesel transport engines*. Industrial Crops and Products, Elsevier, pp.191-197.

- Bocci E., Caffarelli A., Villarini M., D'Amato A., 2011, *Sistemi a biomasse: progettazione e valutazione economica – Impianti di generazione di calore e di elettricità*. Maggioli Editore. Pp.345-362.
- Bodria L., Pellizzi G., Piccarolo P., 2006, *Meccanica Agraria*. Book Vol I. Edagricole.
- Bodria L., Pellizzi G., Piccarolo P., 2013, *Meccanica e Meccanizzazione Agricola*. Edagricole.
- Browne J.D., Murphy J.D., 2013, *Assessment of the resource associated with biomethane from food waste*. Applied Energy 104, Elsevier, pp.170-177.
- Browne J.D., Allen E., Murphy J.D., 2013, *Evaluation of the biomethane potential from multiple waste streams for a proposed community scale anaerobic digester*. Sustainable Technologies: Bioenergy and Biofuel from Biowaste and Biomass 34, pp.2027-2038.
- Castelli S., Negri M., 2011, *La digestione anaerobica: processo e parametric di controllo*. Biomasse ed Energia – Produzione, gestione e processi di trasformazione, Maggioli Editore, pp.163-184.
- Cheng C-C., Lin C-Y., Lin M-C., 2002, *Acid-base enrichment anaerobic hydrogen production process*. Appl. Microbiol. Biotechnol. 58, Springer-Verlang, pp.224-228.
- Cheng C-C., Lin C-Y., Chang J-S., 2001, *Kinetics of hydrogen production with continuous anaerobic cultures utilizing sucrose as the limiting substrate*. Appl. Microbiol. Biotechnol. 57, Springer-Verlang, pp.56-64.
- Chitra P., Venkatachalam P., Sampathrajan A., 2005, *Optimisation of experimental conditions for biodiesel production from alkali-catalyzed transesterification of Jatropha curcus oil*. Energy for Sustainable Development Vol. IX No.3, pp.14-18.

- Chiumenti R., Chiumenti A., 2004, *Valutazioni tecnico-economiche sugli impianti di digestione anaerobica delle deiezioni zootecniche*. Agribusiness Paesaggio & Ambiente, Vol. VII n. 1.
- Chiumenti A., Chiumenti R., Da Borso F., 2007, *La Digestione Anaerobica*. Università degli Studi di Udine, pp.14-27.
- Chung K.H., 2010 *Transesterification of Camellia japonica and Vernicia fordii seed oils on alkali catalysts for biodiesel production*. Journal of Industrial and Engineering Chemistry 16, Elsevier, pp.506-509.
- Ciubota-Rosie C., Ruiz J.R., Ramos M.J., Pérez A., *Biodiesel from Camelina sativa: A comprehensive characterization*. FUEL 105, Elsevier, pp.572-577.
- Cline T., Thomas N., Shumway L., Yeung I., Hansen C.L., Hansen L.D., Hansen J.C., 2012, *Method for evaluating anaerobic digestion performance*. Bioresource Technology 101, Elsevier, pp.8623-8623.
- Cosentino L. S., Copani V., Patanè C., Mantineo M., D'Agosta G. M., 2008, *Le colture da biomassa per energia per gli ambienti italiani. Attualità e prospettive*. Produzione di energia da fonti biologiche rinnovabili. 2 - Le risorse primarie. I Georgofili. Firenze, 163-183.
- Costenoble O., Mittelbach M., Schober S., Fischer J., Haupt J., 2008, *BIOSCopes – Improvements needed for biodiesel standard EN 14214*. Final report for Lot 1 of the Bioscopes project, EC project TREND/D2/44-LOT 1/S07.54676.
- Crescini F. Piante Erbacee Coltivate. 1969, I Grandi Settori dell'Agricoltura 4. Ramo Editoriale degli Agricoltori, 221-234.
- C.R.P.A., 2008, *Biogas: l'analisi di fattibilità tecnico-economica*. Opuscolo C.R.P.A. – No.4/08.

- D'Avino L., Lazzeri L., Dainelli R., Spugnoli P., 2010, *Un software per la valutazione di sostenibilità delle filiere agro-energetiche. Atti del Convegno "Attualità della ricerca nel settore delle energie rinnovabili da biomassa"*. Ancona, Facoltà di Agraria, 16-17 dicembre. 391-400.
- da Silva A.N., Romanelli T.L., Reichardt K., 2010, *Energy flow in castor bean (*Ricinus communis L.*) production systems*. Sci. Agric. (Piracicaba, Braz.), v.67, n.6, 737-742.
- Daffonchio D., 2008, *Il ruolo dei microrganismi nella digestione anaerobica*. Workshop ERSAF, 28 maggio, Mantova.
- Darnoko B., Cheryan M., 2000, *Kinetics of Palm Oil Transesterification in a Batch Reactor*. JAOCS Vol.77, No.12, pp.1263-1267.
- De Baere L.A., Devocht M., Van Assche P., Verstraete W., 1984, *Influence of high NaCl and NH<sub>4</sub>Cl salt levels on methanogenic associations*. Water resource 18, pp.543-548.
- De Poli F., 1989, *Rapporto sul biogas*, sottoprogetto Biomasse ed Agricoltura, PFE.
- Demirbaş A., 2002, *Biodiesel from vegetable oils via transesterification in supercritical methanol*. Energy Conversion and Management 43, Pergamon, pp.2349-2356.
- Demirbaş A., 2005. *Biodiesel production from vegetable oils via catalytic and non-catalytic supercritical methanol transesterification methods*. Progress in Energy and Combustion Science 31, Elsevier, pp.466-487.
- Demirbaş A., 2007, *Comparison of transesterification methods for production of biodiesel from vegetable oils and fats*. Energy Conversion and Management 49, Elsevier, pp. 125-130.

- Devenuto L., Ragazzoni A., 2008, *Il biogas è un affare se la filiera è corta*. Energia Rinnovabile suppl. L'Informatore Agrario 2/8.
- Dinuccio E, Menardo S, Gioielli F, Balsari P., 2009, *Valutazione della potenzialità produttiva, in termini di biogas, di alcune biomasse di origine agroindustriale*. IX National Conference of the Italian Society of Agricultural Engineering, Memory No.10-7, Ischia Porto.
- Dustin J.D., Shaun J., Hansen C.L., 2012, *Completely Stirred Tank Reactor behavior in an unmixed anaerobic digester: the Induced Bed Reactor*. Water Environment Research 84, pp.711-718.
- Ehrensing D.T., Guy S.O., 2008, *Camelina*. Act of Congress "Oilseed Crops". Oregon State University, EM 8953-E.
- ENEL & CRPA, 1996, *Biogas e cogenerazione nell'allevamento suino: manuale pratico*. ENEL Centro ricerche ambiente e materiali.
- Environmental Protection Agency (EPA), 2002., *Managing manure with biogas recovery system: improved performance at competitive costs*. Washington DC.
- Fabrizi C., Piccinini S., 2012, *Bovini da latte e Biogas – Linee guida per la costruzione e la gestione di impianti*. Centro Ricerche Produzioni Animali – C.R.P.A. S.p.a.
- Fangrui M., Davis C.L., Milford H.A., 1998, *Biodiesel Fuel from Animal Fat. Ancillary Studies on Transesterification of Beef Tallow*. Ind. Eng. Chem. Res. Vol.37, No.9, American Chemical Society, pp.3768-3771.
- Fantozzi F., Buratti C., 2009, *Biogas production from different substrates in an experimental Continuously Stirred Tank Reactor anaerobic digester*. Bioresource Technoogy 100, Elsevier, pp.5783-5789.

- Fedeli E., Girelli A., 2001, *Gli oli vegetali come combustibili diesel*. La Chimica e l'Industria 83, RICHMAG Magazine.
- Foppa Pedretti E., Toscano G., Duca D., 2007, *Progetto Biocom – Sintesi dei Risultati*. Programma di sviluppo precompetitivo.
- Fore S. R., Porter P., Lazarus W., 2011, *Net Energy balance of small-scale on farm biodiesel production from canola and soybean*. Biomass and Bioenergy 35, Elsevier, 2234-2244.
- Francis A., Warwick S.I., 2009, The Biology of Canadian Weeds. 142. *Camelina alyssum* (Mill.) Thell.; *C. microcarpa* Andr. ex DC.; *C. sativa* (L.) Crantz. Canadian Journal of Plant Science 89(4), 791-810.
- Gestore dei Servizi Elettrici (GSE), 2012, *Impianti a fonti rinnovabili. Rapporto Statistico 2011*.
- Gestore dei Servizi Elettrici (GSE), 2013, *Rapporto Statistico 2010 UE 27, Settore elettrico*.
- Giraldi D., Cavalaglio G., Massoli S., Servili S., 2007, *Progetto biomasse: energia rinnovabile per le aziende agricole derivante da reflui (ERAAZ)*. 7<sup>th</sup> National Congress of CIRIAF, Perugia.
- Goodrum J.W., 2002, *Volatility and boiling points of biodiesel from vegetable oils and tallow*. Biomass and Bioenergy 22, Elsevier, pp.205-211.
- Gourdon R., Vermande P., 1987, *Effects of propionic acid concentration on anaerobic digestion of pig manure*. Biomass 13, pp.1-12.
- Gugel R.K., Falk K.C., 2006, *Agronomic and seed quality evaluation of Camelina sativa in western Canada*. Canadian Journal of Plant Science; 1047-1058.



- Hansen C.S, Hansen C.L., 2002, *Demonstration of dairy manure remediation using IBR technology*. Proceeding of “Waste Research Technology, Utah State University.
- IEA (International Energy Agency), 2010, *World Energy Outlook 2010*. OECD/IEA, France.
- Karaj S.; Müller J., 2011, *Optimizing mechanical oil extraction of *Jatropha curcas* L. seeds with respect to press capacity, oil recovery and energy efficiency*. Industrial Crops and Products 34, Elsevier, pp. 1010-1016.
- Kartika A.I., Pontalier P.Y., Rigal L., 2010, *Twin-screw extruder for oil processing of sunflower seeds: Thermo-mechanical pressing and solvent extraction in a single step*. Industrial Crops and Products 32, Elsevier, pp. 297-304.
- Kasote D.M., Badhe Y.S., Hegde M.V., 2012, *Effect of mechanical press oil extraction processing on quality of linseed oil*. Industrial Crops and Products 42, 10-13.
- Kormanik R.A., 1968, *A Resume of the Anaerobic Digestion Process*. W. and S.W. reference No., pp.154-166.
- Kumar R., Tiwari P., Garg S., 2013, *Alkali transesterification of linseed oil for biodiesel production*. Fuel 104, Elsevier, pp.553-560.
- Lang X., Dalai A.K., Bakhshi N.N., Reaney M.J., Hertz P.B., 2001, *Preparation and characterization of bio-diesels from various bio-oils*. Bioresource Technology 80, Elsevier, pp.53-62.
- Lazzeri L., D'Avino L., Mazzoncini M., Antichi D., Mosca G., Zanetti F., Del Gatto A., Pieri S., De Mastro G., Grassano N., Cosentino S., Copani V., Ledda L., Farci R., Bezzi G., Lazzari A., Dainelli R., Spugnoli P., 2009, *On farm agronomic and first environmental evaluation of oil crops for*

*sustainable bioenergy chains*. Italian Journal of Agronomy, Vol. 4 (4), p. 171-180.

Leitner S., 2008, *L'immisione in rete del biogas*. Energia Rinnovabile suppl. L'Informatore Agrario 2/8.

Leung D.Y.C., Wu X., Leung M.K.H., 2010, *A review on biodiesel production using catalyzed transesterification*. Applied Energy 87, Elsevier, pp.1083-1095.

Liu S., Wang Y., Oh. J.H., Herring J.L., 2011, *Fast biodiesel production from beef tallow with radio frequency heating*. Renewable Energy 36, Elsevier, pp.1003-1007.

Mapelli S., Pecchia P., 2011, *Oli vegetali e biocarburanti*. Biomasse ed Energia – Produzione, gestione e processi, Maggioli Editore, pp.591-613.

Mazzoncini M., Vannozzi G.P., Megale P., Secchiari P., Pistoia A., Lazzeri L., 1993, *Ethiopian Mustard (Brassica Carinata A.Braun) Crop in Central Italy*. Note 1: Characterization and agronomic evaluation. Agricoltura mediterranea 123, 330-338.

MeherL.C., Dharmagadda V.S.S., Naik S.N., 2006, *Optimization of alkali-catalyzed transesterification of Pogamia pinnata oil for production of biodiesel*. Bioresource Technology 97, Elsevier, pp.1392-1397.

Michaelides E.E., 2012, *Alternative Energy Sources*. Green Energy and Tecnology, Springer-Verlag Berlin Heidelberg, 287-311.

Monni M., 2013; *La strategia nazionale per lo sviluppo energetico*. Mondo Macchina, anno XXII, n. 3-4. 44-45.

Monteleone G., De Francesco M., Galli S., Gilson P., Marchetti M., Naticchioni V., Santomassimo S., Valente F., 2011, *Rimozione degli*

*inquinanti da una corrente di biogas mediante l'utilizzo di carboni attivi.*  
Ricerca di sistema elettrico, Report RdS/2011/265, ENEA.

Monti A., Venturi G., 2007, *Il contributo delle colture da energia alla sostenibilità ambientale.* Accademia Nazionale di Agricoltura. Annali Edizione straordinaria CXXVII, pp.115-131.

Murphy D. J., Hall C. A. S., 2010, *Year in review EROI on energy return on (energy) invested.* Annals of the New York Academy of Sciences; 1185, 102-118, New York.

Nakpong P., Wootthikanokkhan S., 2010, *Optimization of biodiesel production from Jatropha curcas L. oil via alkali-catalyzed methanolysis.* Journal of Sustainable Energy & Environment 1, pp.105-109.

Nath K., Das D., 2004, *Improvement of fermentative hydrogen production: various approaches.* Appl. Microbiol. Biotechnol. 65, Springer-Verlang, pp. 520-529.

Navarotto P., 2011, *Impianti per la digestione anaerobica.* Biomasse ed Energia – Produzione, gestione e processi, Maggioli Editore, pp.205-230.

Ortenzi M., 2013, *Europa ed agro energie, un quadro articolato.* Mondo Macchina, anno XXII, n. 3-4; 42-43.

Ozkan B., Fert C., Karadeniz F.C., 2007, *Energy and cost analysis for greenhouse and open-field grape production.* Energy 32, Elsevier, 1500-1504

Pracha A.S., Volk T.A., 2011, *An Edible Energy Return on Investment (EEROI) Analysis of Wheat and Rice in Pakistan.* Sustainability 3, Elsevier, 2358-2391.

- PAN, 2010, *Piano di Azione Nazionale per le energie rinnovabili dell'Italia*. Ministero dello Sviluppo Economico.
- Pandolfo R., Masi S., Ascoli S., 2004, *Stima delle emissioni di biogas dalle discariche di RSU*. Juridical Journal AmbienteDiritto.it.
- Pantaleo A., Carone M.T., Pellerano A., 2009, *Confronto tra scenari di conversione energetica dei sottoprodotti della filiera olivicolo-olearia*. IX National Conference of the Italian Society of Agricultural Engineering, Memory No.10-2, Ischia Porto.
- Piccinini S., Bonazzi G., Fabbri C., Sassi D., Schiff M.C., Soldano M., Verzellesi F., 2008, *Energia dal biogas – Prodotto da effluenti zootecnici, biomasse dedicate e di scarto*. AIEL Editore.
- Pimentel D., Pimentel M.H., 2008, *Food, Energy, and Society – Third edition*. CRC Press – Taylor and Francis Group.
- Rasi S., 2009, *Biogas Composition and Upgrading to Biomethane*. Jyväskylä studies in biological and environmental science 202, Jyväskylä University Printing House.
- Rashid U., Anwar F., Moser B.R., Ashraf S., 2008, *Production of sunflower oil methyl esters by optimized alkali-catalyzed methanolysis*. Biomass and Bioenergy 32, Elsevier, pp.1202-1205.
- Ravasio N., Zaccheria F., 2011, *Il biodiesel*. Biomasse ed Energia – Produzione, gestione e processi, Maggioli Editore, pp.630-653.
- Reza Shahbazi M., Khoshandam B., Nasiri M., Ghazvini M., 2012, *Biodiesel production via alkali-catalyzed transesterification of Malaysian RBD palm oil – Characterization, kinetics model*. Journal of the Taiwan Institute of Chemical Engineers 43, Elsevier, pp.504-510.

- Riva G., Foppa Pedretti E., Toscano G., 2008, *Biocombustili e biocarburanti: aspetti generali e tecnici della loro produzione e utilizzo*. Produzione di energia da fonti biologiche rinnovabili. 1 - Le tecnologie. I Georgofili. Firenze, 163-183.
- Riva G., Toscano G., Foppa Pedretti E., Duca D., 2009, *Utilizzo di tecniche innovative per la transesterificazione di oli vegetali*. Proceeding of the National Meeting AIIA, Ischia Porto.
- Rivoira G., 2001, Lino (*Linum usitatissimum* L.) - *Coltivazioni Erbacee, piante oleifere, da zucchero, da fibra, orticole e aromatiche*. vol. 2, 213-218, Pàtron Editore.
- Saleh J., Tremblay A.Y., Dubé M.A., 2010, *Glycerol removal from biodiesel using membrane separation technology*. FUEL 89, Elsevier, pp.2260-2266.
- Sawangkeaw R., Bunyakiat K., Ngamprasertsith S., 2011, *Continuous production of biodiesel with supercritical methanol: Optimization of a scale-up plug flow reactor by response surface methodology*. Fuel Processing Technology 92, Elsevier, pp.2285-2292.
- Scammel G.W. 1975, *Anaerobic treatment of industrial wastes*, Process Biochemistry.
- Sharma Y.C., Singh B., Upadhyay S.N., 2008, *Advancement in development and characterization of biodiesel: A Review*. FUEL 87, Elsevier, pp.2355-2373.
- Sigh J., Bargale P.C., 2000, Development of a small capacity double stage compression screw press for oil expression. Journal of Food Engineering 43, 75-82.
- Sigh N.C., Mohapatra P.K.J., Pandey K.P., 2006, *Improving energy productivity in paddy production through benchmarking—An application of*

*data envelopment analysis*. Energy Conversion & management 47, 1063-1085

Soo-Young N., 2011, *Inedible vegetable oils and their derivatives for alternative diesel fuels in CI engines: A review*. Renewable and Sustainable Energy Reviews 15, Elsevier, pp.131-149.

Speece R.E., 1996, *Anaerobic biotechnology for industrial wastewater*. Archae Press, Nashville, Tennessee.

Taiganides E.P., Baumann E.R., Johnson H.P., Hazen T.E., 1979, Anaerobic Digestion of hog wastes. Annual report by Institute of Gas Technology, Chicago, pp. 327-333.

Unakitan G., Hurma H., Yilmaz F., 2010, *An analysis of energy use efficiency of canola production in Turkey*. Energy, n.35; 3623-2627.

Verani S., Sperandio G., Picchio R., Savelli S., 2008, *Nozioni di base per la costituzione di micro filiere energetiche di autoconsumo*. Progetto sportello COFEA. Tipografia Bonanni, Roma.

Vicente G., Martínez M., Aracil J., 2007, *Optimisation of integrated biodiesel production. Part I. A study of the biodiesel purity and yield*. Bioresource Technology 98, Elsevier, pp.1724-1733.

Vismara R., 1976, *Aspetti biochimici e biologici della digestione anaerobica*. Ingegneria Ambientale, March-April.

Volpi R., 1992 *Bilanci energetici in agricoltura*. Laruffa Editore, Reggio Calabria.

Wilkie A., Goto M., Bordeaux F.M., Smith P.H., 1986. *Enhancement of anaerobic methanogenesis from napier grass by addition of micronutrients*. Biomass 11, pp.135-146.

- Wilkie C., 2005, *Anaerobic Digestion: Biology and Benefits*. Dairy Manure management: Treatment, Handling and Community relations, Cornell University, Itacha, pp.63-72.
- Wong M.H., Cheung Y.H., 1995, *Gas production and digestion efficiency of sewage sludge containing elevated toxic metals*. *Bioresource Technology* 54, pp.261-268.
- Zennaki B.Z., Zadi A., Lamini H., Aubinear M., Boulif M., 1996, *Methane fermentation of cattle manure: effects of HRT, temperature & substrate concentration*. *Tropicultural* 14, pp.134-140.
- Zeza A., 2008, *Bioenergie: quali opportunità per l'agricoltura italiana*. Napoli, Edizioni Scientifiche Italiane.
- Zhang Y., Dubé M.A., McLean D.D., Kates M., 2003, *Biodiesel production from waste cooking oil: 1. Process design and technological assessment*. *Bioresource Technology* 89, Elsevier, pp.1-16
- Zhao Q., Leonhardt E., MacConnell C., Frear C., Chen S., 2010, *Purification Technologies for Biogas Generated by Anaerobic Digestion*. CSANR Research Report-001, Climate Friendly Farming.
- Zheng Y., Wiesenborn D.P., Tostenson K., Kangas N., 2005, *Energy analysis in the screw pressing of whole and dehulled flaxseed*. *Journal of Food Engineering* 66, Elsevier, pp.193-202.
- Zubr J., 1996, *Oil-seed crop: Camelina sativa*. *Industrial Crops and Products* 6, 113-119.
- Zullo L., Fiorese G., Gatto M., Guariso G., Consonni S., 2005, *Stima della disponibilità di biomassa e alternative di utilizzo energetico: un'applicazione alla provincia di Piacenza*. 15<sup>th</sup> Meeting of the Italian Society of Ecology.

## **Acknowledgements**

I am earnestly indebted to my supervisor Dr Sabina Failla under whose highly experienced guidance, inspiring support, insightful comments and suggestions and motivation the research proved fruitful. Dr Sabina Failla is one person who remains available to her university and her students beyond the call of duty even at the cost of hers home life. Therefore I express my gratitude to her again.

I am grateful to Prof. Schillaci who was kind to provide valuable guidance, comments and suggestions related to the results and when not available in person, responded my queries on e-mail.

I must say thanks to all the Mechanics and Mechanization Researchers group that helped me during the four years of my PhD course. Among others who extended their hand of assistance in laboratory and in the field are Eng. Domenico Longo, Dr Davide Camillieri, Dr Andrea Conti and Dr Luciano Caruso as their input contributed to shape this thesis.

A special thanks goes to my family who support and encourage me in every day of my life.

Last but not the least I express my deep gratitude to my girlfriend, Daniela for her presence who inspired me to complete this research.

*Thank you very much!*

*Andrea Restuccia*